

PRICE \$1.00



**Assembling
and Using Your...**

Heathkit

**SINE-SQUARE
WAVE GENERATOR**

MODEL AG-10

HEATH COMPANY

A Subsidiary of Daystrom Inc

BENTON HARBOR, MICHIGAN

HELPFUL KIT BUILDING INFORMATION

Before attempting actual kit construction read the construction manual through thoroughly to familiarize yourself with the general procedure. Note the relative location of pictorials and pictorial inserts in respect to the progress of the assembly procedure outlined.

This information is offered primarily for the convenience of novice kit builders and will be of definite assistance to those lacking thorough knowledge of good construction practices. Even the advanced electronics enthusiast may benefit by a brief review of this material before proceeding with kit construction. In the majority of cases, failure to observe basic instruction fundamentals is responsible for inability to obtain desired level of performance.

RECOMMENDED TOOLS

The successful construction of Heathkits does not require the use of specialized equipment and only basic tools are required. A good quality electric soldering iron is essential. The preferred size would be a 100 watt iron with a small tip. The use of long nose pliers and diagonal or side cutting pliers is recommended. A small screw driver will prove adequate and several additional assorted screw drivers will be helpful. Be sure to obtain a good supply of rosin core type radio solder. Never use separate fluxes, paste or acid solder in electronic work.

ASSEMBLY

In the actual mechanical assembly of components to the chassis and panel, it is important that the procedure shown in the manual be carefully followed. Make sure that tube sockets are properly mounted in respect to keyway or pin numbering location. The same applies to transformer mountings so that the correct transformer color coded wires will be available at the proper chassis opening.

Make it a standard practice to use lock washers under all 6-32 and 8-32 nuts. The only exception being in the use of solder lugs—the necessary locking feature is already incorporated in the design of the solder lugs. A control lock washer should always be used between the control and the chassis to prevent undesirable rotation in the panel. To improve instrument appearance and to prevent possible panel marring use a control flat nickel washer under each control nut.

When installing binding posts that require the use of fiber insulating washers, it is good practice to slip the shoulder washer over the binding post mounting stud before installing the mounting stud in the panel hole provided. Next, install a flat fiber washer and a solder lug under the mounting nut. Be sure that the shoulder washer is properly centered in the panel to prevent possible shorting of the binding post.

WIRING

When following wiring procedure make the leads as short and direct as possible. In filament wiring requiring the use of a twisted pair of wires allow sufficient slack in the wiring that will permit the twisted pair to be pushed against the chassis as closely as possible thereby affording relative isolation from adjacent parts and wiring.



































When removing insulation from the end of hookup wire, it is seldom necessary to expose more than a quarter inch of the wire. Excessive insulation removal may cause a short circuit condition in respect to nearby wiring or terminals. In some instances, transformer leads of solid copper will have a brown baked enamel coating. After the transformer leads have been trimmed to a suitable length, it is necessary to scrape the enamel coating in order to expose the bright copper wire before making a terminal or soldered connection.

In mounting parts such as resistors or condensers, trim off all excess lead lengths so that the parts may be installed in a direct point-to-point manner. When necessary use spaghetti or insulated sleeving over exposed wires that might short to nearby wiring.

It is urgently recommended that the wiring dress and parts layout as shown in the construction manual be faithfully followed. In every instance, the desirability of this arrangement was carefully determined through the construction of a series of laboratory models.

SOLDERING

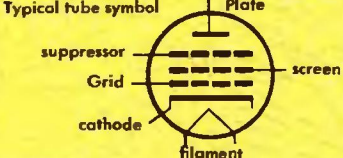
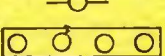
Much of the performance of the kit instrument, particularly in respect to accuracy and stability, depends upon the degree of workmanship used in making soldered connections. Proper soldered connections are not at all difficult to make but it would be advisable to observe a few precautions. First of all before a connection is to be soldered, the connection itself should be clean and mechanically strong. Do not depend on solder alone to hold a connection together. The tip of the soldering iron should be bright, clean and free of excess solder. Use enough heat to thoroughly flow the solder smoothly into the joint. Avoid excessive use of solder and do not allow a flux flooding condition to occur which could conceivably cause a leakage path between adjacent terminals on switch assemblies and tube sockets. This is particularly important in instruments such as the VTVM, oscilloscope and generator kits. Excessive heat will also burn or damage the insulating material used in the manufacture of switch assemblies. Be sure to use only good quality rosin core radio type solder.

Antenna General		Resistor General		Neon Bulb		Receptacle two-conductor	
Loop		Resistor Tapped		Illuminating Lamp		Battery	
Ground		Resistor Variable		Switch Single pole Single throw		Fuse	
Inductor General		Potentiometer		Switch double pole single throw		Piezoelectric Crystal	
Air core Transformer General		Thermistor		Switch Triple pole Double throw		1000 = K	
Adjustable Powdered Iron Core		Jack two conductor		Switch Multipoint or Rotary		1,000,000 = M	
Magnetic Core Variable Coupling		Jack three conductor		Speaker		OHM = Ω	
Iron Core Transformer		Wires connected		Rectifier		Microfarad = MF	
Capacitor General		Wires Crossing but not connected		Microphone		Micro Microfarad = MMF	
Copacitor Electrolytic		A. Ammeter V. Voltmeter		Typical tube symbol 		Binding post Terminal strip 	
Copacitor Variable		G. Galvanometer MA. Milliammeter uA. Microammeter, etc.				Wiring between like letters is understood 	

ASSEMBLY AND OPERATION OF THE HEATHKIT SINE-SQUARE WAVE GENERATOR MODEL AG-10



SPECIFICATIONS

Sine Wave:

Frequency Range:.....	20 cycles - 1 MC	
Output Volts (rms):.....	0-10 volts	} Into a high impedance load.
	0-1 volt	
	0-.1 volt	
	0-.01 volt	

Source Impedance ($\pm 10\%$):..... 10 volt range - Hi-Z;
1V, .1V, and .01 V range - 600 Ω

Distortion:..... Less than .25%
20 to 20,000 cycles

Frequency Response:..... ± 1.5 db
20 cycles to 1 megacycle

Square Wave:

Frequency Range:.....	20 cycles - 1 MC	
Output Volts (peak-to-peak) $\pm 5\%$:.....	0-10 volt	} Into a high impedance load
	0-1 volt	
	0-.1 volt	

Source Impedance ($\pm 10\%$):..... 10 volt range - 0 to 220 Ω
1V, and .1V ranges - 52 Ω

Rise Time:..... Less than .15 micro-second

General:

Frequency Accuracy:..... $\pm 5\%$
Power Requirements:..... 105-125 VAC, 50-60 cycles
55 watts

Dimensions:..... 13" wide x 8 1/2" high x 7" deep
Shipping Weight:..... 12 lbs.

INTRODUCTION

The Heathkit Model AG-10, is a wide range, high quality, sine and square wave generator whose frequency coverage extends from the bottom of the audio band to almost half way through the broadcast band. Although the number of components is considerably smaller than similar commercial instruments, the rise time of the square wave is extremely short, and the sine wave distortion is unusually low. The wide frequency range and high quality waveforms will make this instrument extremely useful in general laboratory use as well as in audio, television, and high fidelity applications.

BIBLIOGRAPHY

Radiation Lab. Series Electronics Electronics Radio Electronics Radio and TV News	Volume 19 "Waveforms" May 1955 May 1953 July 1954 June 1951	McGraw-Hill Peter Sulzer Savant Graham Jack Gallagher - W5HZB
---	---	---

CIRCUIT DESCRIPTION

The circuitry in your "sine-square generator" can be divided into three general parts, the sine wave section, the square wave section, and the power supply.

The power supply is a full wave voltage doubler, where, due to the action of the silicon rectifiers, each half of the 117 volt, 60-cycle input sine wave, charges up its own 50 μ fd capacitor. These two capacitors are arranged in the circuit in such a way that the two charges are added together to provide B+ for the rest of the instrument. From the 50-50 μ fd capacitors, the current path goes through a ripple filter (100 μ fd, 250 Ω , 40 μ fd), from where it is decoupled to the plate supplies of the various stages.

The sine wave section is composed of a "Bridged-T Oscillator" with a cathode follower output stage. The 6CB6 serves as a high gain, broad band voltage amplifier, and the two 6CL6's are both cathode followers. The first 6CL6, V-2, provides regenerative feedback through the tungsten filament of the 3-watt lamp, to the cathode of the 6CB6.

The same 6CL6, provides degenerative feedback to the grid of the 6CB6 through the bridged-T (or "notch") network. The resulting oscillation occurs at the frequency where degeneration is minimum and the phase shift is zero. Perhaps a simpler way of stating this, would be to say that there is sufficient degeneration to stop oscillation at all frequencies, except at the point where the phase shift is zero. At this point the degeneration decreases to a level where oscillation occurs.

The resonant point of the circuit or "Notch", occurs where

$$\text{frequency} = \frac{1}{2\pi RC} \quad R = \sqrt{R_1 R_2}$$

The amplitude of oscillation is held nearly constant by the operation of the tungsten lamp. An increase in the output increases the regenerative feedback through the lamp, thereby increasing the lamp current. This increase in current makes the lamp temperature rise and increases its resistance, thereby decreasing the amount of feedback that passes

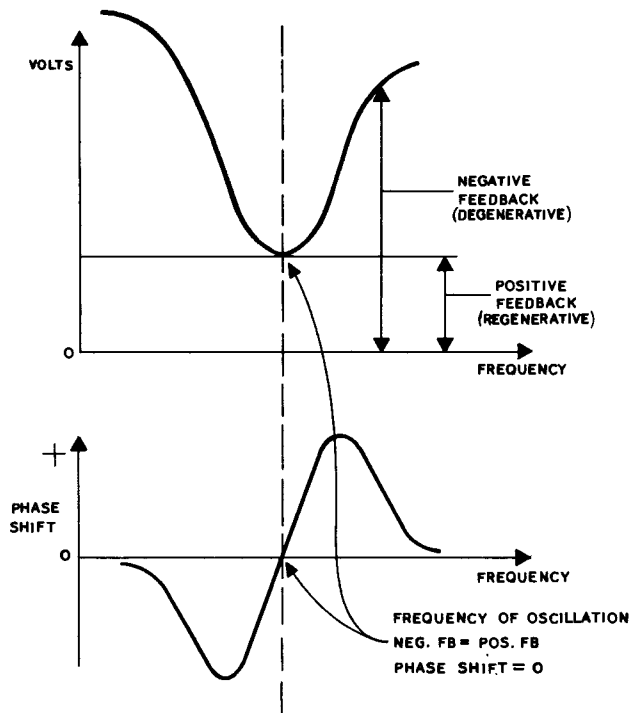

Sketch 1 A

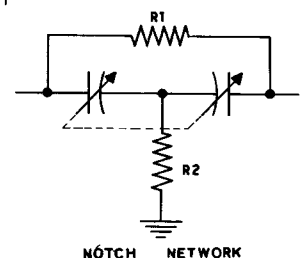

Sketch 1 B

through to the cathode of V-1 and therefore lowering the output. A decrease in output would affect the lamp in the opposite way, and increase the feedback and output.

The second cathode follower provides complete isolation between the oscillator and the output.

The attenuator supplies a 600Ω output impedance up through the 1 volt position. The 10 volt position has a variable impedance depending on the setting of the variable output control.

The "feedback" control varies the amount of feedback to the cathode of the 6CB6 and therefore controls the strength of oscillation.

The "flatness adj." trims one side of the tuning capacitor to exactly the same capacity as the other side. Small differences in capacity, especially at the full open position of the tuning capacitor, tend to make the output level change as the upper end of the calibrated frequency scale is approached.

The "frequency adj." adds or subtracts capacity from both sides of the tuning capacitor simultaneously. As can be seen from the "notch" formula, this raises or lowers the frequency.

The "distortion adj." adjusts the bias, and therefore the operating point, of the 6CB6.

SQUARE WAVE SECTION

The square wave section contains an input cathode-follower, a "Schmitt Trigger Circuit", an output cathode follower, and an attenuator circuit.

The "input" cathode follower serves as an isolation stage to keep the square waves from getting back into the sine wave section. The sine wave input to this tube is taken from the "Notch" network, since this is the closest place on the chassis where a sine wave is available.

The "output" cathode follower isolates the "Schmitt Trigger Circuit", by acting as a step-down impedance transformer. This is to keep external connections from affecting the quality of the square wave.

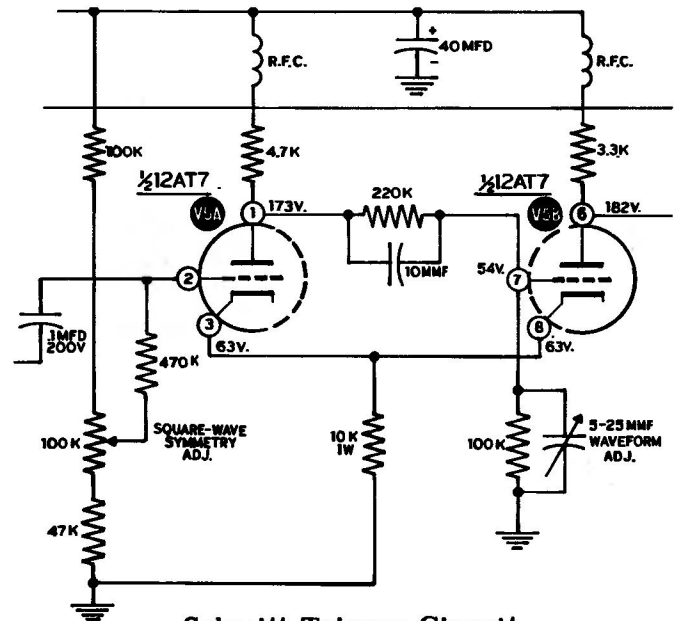

Schmitt Trigger Circuit

The "Schmitt Trigger Circuit" is, basically, a modification of the cathode-coupled multivibrator, except that the circuit action is a result of DC level changes and the circuit has no built-in time constants. In this application, assuming no input signal, the input triode, V-5A, is normally conducting and the output triode, V-5B, is normally cut off. As an input signal is applied to the grid of V-5A, and starts going in a negative direction, the plate current starts to decrease, therefore, increasing the plate voltage. Due to the 220K and 100 KΩ voltage divider, this increase in plate voltage also increases the voltage at the grid of V-5B and starts to bring that stage out of its cut-off condition. As soon as V-5B grid voltage increases to the point where V-5B begins to conduct, its plate current increases the voltage across the 10 KΩ common cathode resistor.

This increase in cathode voltage decreases the plate current of V-5A still further, and the action of the previous steps quickly repeat themselves until V-5A is in a cut-off condition, and V-5B is in saturation. The circuit stays in this condition until the input voltage at the grid of V-5A returns again to the positive voltage that allows V-5A to begin conducting. When this happens, the circuit acts the same way as described in the previous paragraph only in the reverse direction, and returns to the state it was in when we first assumed no input signal.

Thus it can be seen that a sine wave, triggering V-5A on and off at a regular rate, will produce square waves at the plate of V-5B. The negative portion of the square wave is when V-5B is conducting, and the positive portion is when V-5B is cut-off. The vertical lines are the times when the circuit is changing over from one state to the other.

The attenuator is designed for a 52Ω output impedance in the .1V and 1.0V position, and a variable impedance in the 10V position, depending on the setting of the variable output control.

NOTES ON ASSEMBLY AND WIRING

This manual is supplied to assist you in every way to complete the instrument with the least possible chance for error. We suggest that you take a few minutes now and read the entire manual through before any work is started. This will enable you to proceed with the work much faster when construction is started. The large fold-in pictorials are handy to attach to the wall above your work space. Their use will greatly simplify the completion of the kit. These diagrams are repeated in smaller form within the manual. We suggest that you retain the manual in your files for future reference, both in the use of the instrument and for its maintenance.

UNPACK THE KIT CAREFULLY AND CHECK EACH PART AGAINST THE PARTS LIST. In so doing, you will become acquainted with each part. Refer to the charts and other information shown on the inside covers of the manual to help you identify any parts about which there may be a question. If some shortage is found in checking the parts, please notify us promptly and return the inspection slip with your letter to us. Hardware items are counted by weight and if a few are missing, please obtain them locally if at all possible.

Resistors and controls generally have a tolerance rating of $\pm 20\%$ unless otherwise stated in the parts list. Therefore a $100\text{ K}\Omega$ resistor may test anywhere from $80\text{ K}\Omega$ to $120\text{ K}\Omega$. (The letter K is commonly used to designate a multiplier of 1000.) Tolerances on condensers are generally even greater. Limits of $+100\%$ and -50% are common for electrolytic condensers. The parts furnished with your Heathkit have been specified so as to not adversely affect the operation of the finished instrument.

In order to expedite delivery to you, we are occasionally forced to make minor substitutions of parts. Such substitutions are carefully checked before they are approved and the parts supplied will work satisfactorily. By checking the parts list for resistors, for example, you may find that a 1200Ω resistor has been supplied in place of a $1\text{ K}\Omega$ as shown in the parts list. These changes are self-evident and are mentioned here only to prevent confusion in checking the contents of your kit.

Most kit builders find it helpful to separate the various parts into convenient categories. Muffin tins or molded egg cartons make convenient trays for small parts. Resistors and capacitors may be placed in the edge of a piece of corrugated cardboard until they are needed. Values can be written on the cardboard next to each component. The illustration shows one method that may be used. Read through the entire manual before starting construction. In this way you will become familiar with the techniques employed in the building of your kit. As a further deterrent to errors, read each step of the construction and wiring completely before performing that step.

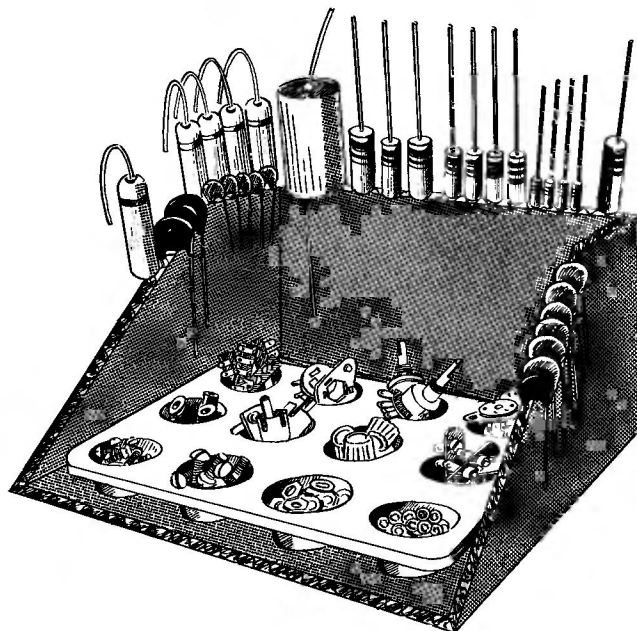

Read the notes on soldering and wiring on the inside rear cover. Crimp all leads tightly to the terminal before soldering. Be sure both the lead and terminal are free of wax, corrosion or other foreign substances. Use only the best rosin core solder, preferably a type containing the new activated fluxes such as Kester "Resin-Five," Ersin "Multicore" or similar types.

Unless otherwise indicated, all wire used is insulated. Wherever there is a possibility of the bare leads on resistors and capacitors shorting to other parts or to chassis, the leads should be covered with insulated sleeving. This is indicated in the instructions by the phrase "use sleeving." Bare wire is used where the lead lengths are short and the possibility of short circuits are non-existent.

Leads on resistors, capacitors and transformers are generally much longer than they need to be to make the indicated connections. In these cases, the excess leads should be cut off before the part is added to the chassis. In general, the leads should be just long enough to reach their terminating points. Not only does this make the wiring much neater but in many instances, the excessively long leads will actually interfere with proper operation of the instrument.

The pictorials indicate actual chassis wiring and designate values of the component parts. We very strongly urge that the chassis layout, lead placement and grounding connections be followed exactly as shown. While the arrangement shown is probably not the only satisfactory layout, it is the result of considerable experimentation and trial. If followed carefully, it will result in a stable instrument operating at a high degree of accuracy and dependability.

Space has been provided for you to check off each operation as it is completed. This is particularly important in wiring and it may prevent omissions or errors, especially where your work is interrupted frequently as the wiring progresses. Some kit builders have also found it helpful to mark each lead in colored pencil on the pictorial as it is added.

PROPER SOLDERING PROCEDURE

Only a small percentage of Heathkit purchasers find it necessary to return an instrument for factory service. Of these, by far the largest proportion function improperly due to poor or improper soldering.

Correct soldering technique is extremely important. Good solder joints are essential if the performance engineered into the kit is to be fully realized. If you are a beginner with no experience in soldering, a half-hour's practice with odd lengths of wire and a tube socket will be a worthwhile investment.

High quality solder of the proper grade is most important. There are several different brands of solder on the market, each clearly marked "Rosin Core Radio Solder." Such solders consist of an alloy of tin and lead, usually in the proportion of 50:50. Minor variations exist in the mixture such as 40:60, 45:55, etc. with the first figure indicating the tin content. Radio solders are formed with one or more tubular holes through the center. These holes are filled with a rosin compound which acts as a flux or cleaning agent during the soldering operation.

NO SEPARATE FLUX OR PASTE OF ANY KIND SHOULD BE USED. We specifically caution against the use of so-called "non-corrosive" pastes. Such compounds, although not corrosive at room temperatures, will form residues when heated. The residue is deposited on surrounding surfaces and attracts moisture. The resulting compound is not only corrosive but actually destroys the insulation value of non-conductors. Dust and dirt will tend to accumulate on these "bridges" and eventually will create erratic or degraded performance of the instrument.

NOTE: ALL GUARANTEES ARE VOIDED AND WE WILL NOT REPAIR OR SERVICE INSTRUMENTS IN WHICH ACID CORE SOLDER OR PASTE FLUXES HAVE BEEN USED. WHEN IN DOUBT ABOUT SOLDER, IT IS RECOMMENDED THAT A NEW ROLL PLAINLY MARKED "ROSIN CORE RADIO SOLDER" BE PURCHASED.

If terminals are bright and clean and wires free of wax, frayed insulation and other foreign substances, no difficulty will be experienced in soldering. Crimp or otherwise secure the wire (or wires) to the terminal, so a good joint is made without relying on solder for physical strength. To make a good solder joint, the clean tip of the soldering iron should be placed against the joint to be soldered so that the terminal is heated sufficiently to melt solder. The solder is then placed against both the terminal and the tip of the iron and will immediately flow out over the joint. Refer to the sketch below. Use only enough solder to cover wires at the junction; it is not necessary to fill the entire hole in the terminal with solder. Excess solder may flow into tube socket contacts, ruining the socket, or it may creep into switch contacts and destroy their spring action. Position the work so that gravity tends to keep the solder where you want it.

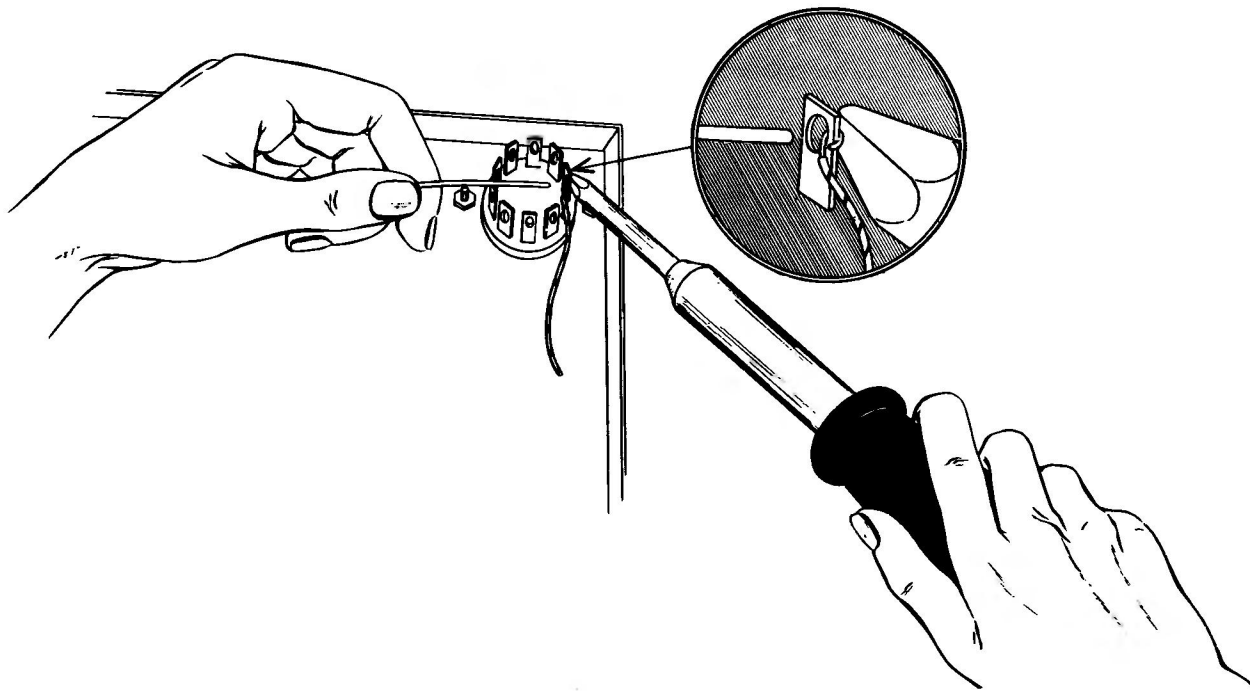

A poor solder joint will usually be indicated by its appearance. The solder will stand up in a blob on top of the connection, with no evidence of flowing out caused by actual "wetting" of the contact. A crystalline or grainy texture on the solder surface, caused by movement of the joint before it solidified is another evidence of a "cold" connection. In either event, reheat the joint until the solder flows smoothly over the entire junction, cooling to a smooth, bright appearance. Photographs in the adjoining picture clearly indicate these two characteristics.

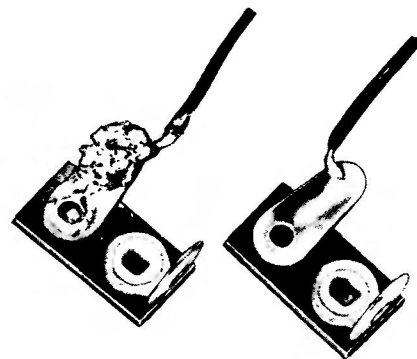

A good, clean, well-tinned soldering iron is also important to obtain consistently perfect connections. For most wiring, a 60 or 100 watt iron, or the equivalent in a soldering gun, is very satisfactory. Smaller irons generally will not heat the connections enough to flow the solder smoothly over the joint and are recommended only for light work, such as on etched circuit boards, etc. Keep the iron tip clean and bright. A pad of steel wool may be used to wipe the tip occasionally during use.

Take these precautions and use reasonable care during assembly of the kit. This will insure the wonderful satisfaction of having the instrument operate perfectly the first time it is turned on.

HELPFUL HINTS

1. Don't apply too much solder to the solder joint. Don't apply the solder to the iron only, expecting that it will roll down to the connection. Try to follow the instructions and illustrations on the preceding page as closely as possible.
2. For that close resistor connection (such as between adjacent pins of a tube socket) hold the resistor body in one hand and gently bend the leads close to its body with the index finger of the other hand. Don't do this more than once to the same lead since some resistor leads could break off with continuous bending.
3. Don't bend a lead more than once around a connecting point. If it should have to come off due to a mistake or for maintenance it will be much easier to remove.
4. Keep your soldering iron clean (see page 7). Wipe it quickly from time to time with steel wool or a rag (don't let the rag burn, natch). This will keep solder from slobbering over the solder joints and help the iron to heat better.
5. Tinning a lead -- Heat the stripped lead with the soldering iron and apply solder to it. While the lead is still hot, shake off the excess solder by rapping the hand that holds the lead sharply against the workbench.
6. Two or more connections to the same solder lug -- a common mistake is to neglect soldering the connections on the bottom. Make sure all the wires are soldered.

The abbreviation "NS" indicates that the connection should not be soldered as yet, for other wires will be added. When the last wire is installed, the terminal should be soldered and the abbreviation "S" is used to indicate this. Note that a number appears after each solder (S) instruction. This number indicates the number of leads connected to the terminal in question. For example, if the instructions read, "Connect a 47 K Ω resistor from socket E1 (S-2)" it will be understood that there will be two leads connected to the terminal at the time it is soldered. This additional check will help avoid errors.

We suggest you do the following before any work is started:

1. Attach the large fold-in pictorials to the wall above your work bench.
2. Go through the entire assembly and wiring instructions. This is an excellent time to read the entire instruction section through and familiarize yourself with the procedure.
3. Lay out all parts so that they are readily available. Refer to the general information inside the front and back covers of this manual to help you identify components.

The following instructions are presented in a simple, logical, step-by-step sequence to enable you to complete your kit with the least possible confusion. Be sure to read each step all the way through before you start to do it. When the step is completed, check it off in the space provided.

STEP-BY-STEP ASSEMBLY INSTRUCTIONS

REFER TO PICTORIAL 1 UNTIL DIRECTED OTHERWISE:

- () Lay chassis on its top with flanges facing up and with the front (five 25/64" holes) facing away from you as per Pictorial 1. Use 3-48 screws, nuts, and #3 lockwashers on all sockets with all open spaces facing the rear of the chassis.
- () Install 7-pin socket V-1, bringing the base through from the top of the chassis. The other four sockets will mount from the bottom.

NOTE: On examination, it will be found that the mounting holes for terminal strips B and K are large enough for 8-32 screws, whereas the others are not. Put these two to one side for now so they will not be confused with the others.

- () Install 9-pin mica-filled socket V-2, installing terminal strip "H" between the socket and chassis on the side facing the chassis front.

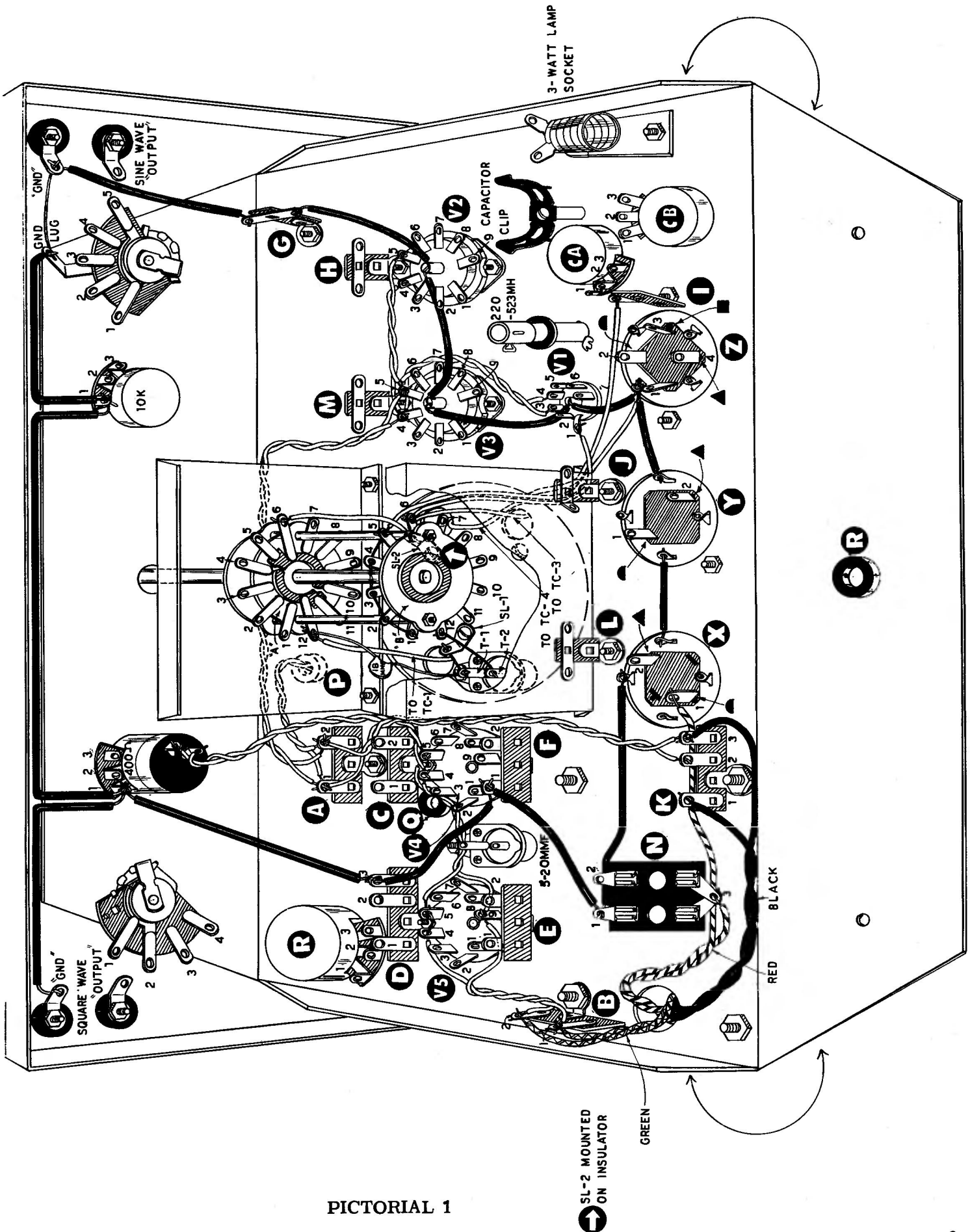

PICTORIAL 1

SL-2 MOUNTED ON INSULATOR

GREEN

RED
BLACK

- () Install 9-pin mica-filled socket V-3, installing terminal strip "M" between the socket and chassis as in Pictorial 1. Gently bend each pin of sockets V-1, V-2, and V-3 outward about 30 or 40 degrees to make connecting to them easier.
- () Install wafer socket V-4, mounting terminal strips "C" and "F" between the socket and chassis as in Pictorial 1.
- () Install wafer socket V-5, mounting terminal strips "D" and "E" between the socket and chassis as in Pictorial 1.

NOTE: When making connections to V-4 and V-5, it would be best to make as many connections as possible to the top hole in each pin in these wafer sockets since its easy to short to the pins from the bottom holes.

- () Install silicon rectifier holder at "N", noting that the two shorted terminals face the rear of the chassis. Put the two 6-32 flat-headed screws through the holder and put the nuts and lockwashers on the top of the chassis in the dimples provided.
- () Install terminal strip "G" as shown in the pictorial using 6-32 hardware (screw, lock-washer and nut).
- () Install terminal strip "A" as shown in pictorial using 6-32 hardware.
- () Install grommets "P", "Q", and "R" in their appropriate mounting holes.
- () Install the 5-20 $\mu\mu\text{f}$ trimmer (marked on the side) between V-4 and V-5 as shown in Pictorial 1.
- () Install capacitor mounting wafers X, Y, and Z on top of the chassis with 6-32 hardware. Put mounting terminals "I", "J" and "L" in their proper places beneath the chassis in the process.
- () Install 3K control CB in the hole next to capacitor mounting wafer Z, facing the lugs toward the front of the chassis as shown. Refer to Figure 5 on Page 14 for the proper mounting procedure.
- () Install the 3-watt lamp base using 6-32 hardware in the small hole to the outside of the 3K control.
- () Install tab mounting CA control just forward of the 3K control in the mounting holes provided. The lugs should face toward mounting wafer Z. Bend the tabs over to lock it securely in position.
- () Using the 6-32 x 1" screw, the 3/4" spacer, and a nut and lockwasher, mount the capacitor clip in the 5/32" hole just outside the tab-mounting control. When mounted, the screw head should be in the clip, the spacer between the clip and the chassis and the lockwasher and nut on top of the chassis. Align the clip to be parallel with the front and rear chassis aprons.
- () Install 100K control R, in the hole provided just forward of terminal strip "D". Orient the lugs as shown.
- () Mount the power transformer using 8-32 hardware, run the leads through the hole near the silicon rectifier holder. At this time terminal strips "B" and "K", which were set aside in Step 3, may be installed in their proper places on the 8-32 transformer mounting screws.
- () Place the tuning capacitor mounting insulator over the large hole on top of the chassis as shown in Figure 1 on Page 11. Orient the large hole nearest the edge of the insulator to the corner toward the power transformer. Using 6-32 hardware, install the insulator, together with the upper and lower front shields, as shown. (Do not install the rear shields at this time.)

- () Observe the bases of the three can type capacitors. Note the presence of a circle, square, or triangle at the base of each lug for identification purposes. Mount 50-50 μ fd capacitor "X", oriented as shown in the diagram in the wafer next to the power transformer. This is accomplished by inserting the four lugs on the capacitor case through the slots in the wafer. Make sure its oriented properly with the half-moon terminal facing terminal "K" and then twist each of the four mounting lugs about 1/8 of a turn with long nose pliers, securing it firmly to the wafer.
- () In the same manner mount the 100 μ f and 40 μ f can type capacitor "Y" in the center of the three capacitor mounting wafers. Once again be careful to orient the lugs as shown in the diagram.
- () Mount the remaining 4 x 40 μ f can type capacitor "Z" in the remaining mounting wafer, orienting the ■ coded lug toward terminal strip "I" as shown.

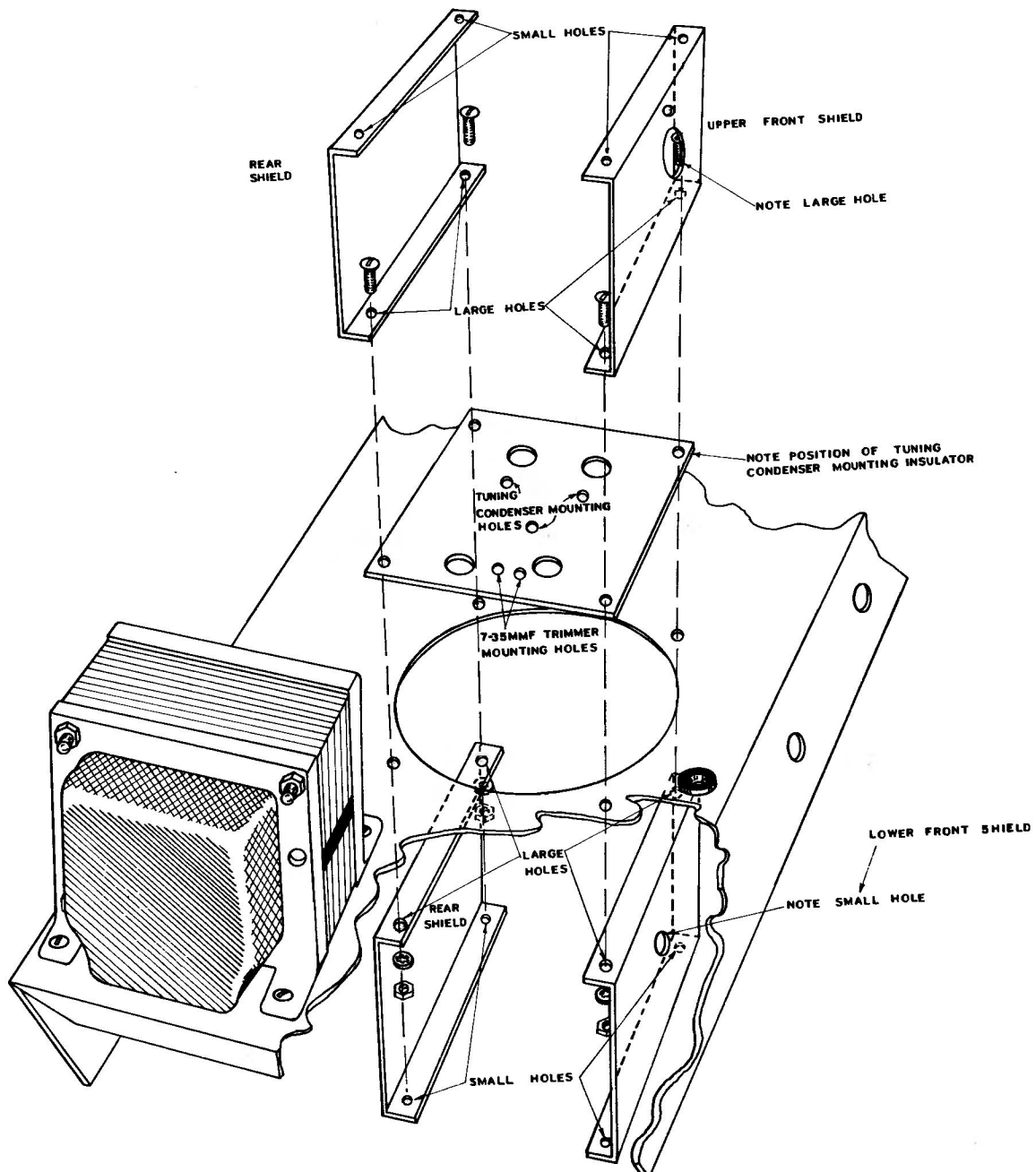

Figure 1

- () Mount the pilot lamp socket on the outside of the upper front shield, using 6-32 hardware in the small hole provided. Orient the socket to face straight up. See Figures 4 and 7.
- () Twist the two green power transformer leads approximately twice and connect to "B1" and "B2" (NS), routing them between the chassis flange and terminal strip "B".
- () Twist the two black leads and routing them around the silicon rectifier holders, connect the short lead to K1 (NS) and the long lead to K3 (NS).
- () Twist the two red leads and connect the short lead to N3 (S) and the long to X1 (S).
- () Twist two 3 1/2" lengths of hookup wire together and strip the insulation from both leads on one end of the twisted pair. Connect one of these leads to V-5 pin 4 (NS) and the other to V-5 pin 9 (NS).
- () Route the twisted pair near the chassis flange down to terminal "B". Trim the leads to size if necessary, strip them, and connect one to B1 (S-2) and the other to B2 (S-2).
- () Connect a short length of bare wire between pin 4 (S-2) and pin 5 (NS) of V-5.
- () Twist two 3 1/4" lengths of hookup wire together and strip the insulation from the leads at one end of the pair. Connect one lead to pin 9 of V-5 (S-2) and the other to pin 5 of V-5 (S-2). Strip the other ends of this pair and connect one of them to pin 4 of V-4 (NS) and the other to pin 5 of V-4 (NS). Route the leads as shown in the diagram.
- () Twist two 3 1/4" lengths of hookup wire together and strip the leads at one end. Connect one lead to pin 4 (S-2) and the other lead to pin 5 (S-2) of V-4. Strip the other end of this pair and connect one of them to A1 (NS) and the other to A2 (NS).
- () Twist two 6 1/2" lengths of hookup wire together and strip all four ends. At one end of the pair, connect one lead to A1 (NS) and the other to A2 (NS). Route the other end of the twisted pair up through grommet "P" connect one lead to each pilot light lug, and solder them both.
- () Twist two 9" lengths of hookup wire together and strip all four leads. Connect the leads at one end of the pair to A1 (S-3) and A2 (S-3). Route the pair down the front edge of the chassis near the flange. Bring it down to V-3 on the other side of the lower front shield (as shown in the diagram) and connect one lead to pin 4 (NS) and the other lead to pin 5 (NS).
- () Twist two 3 1/4" lengths of hookup wire together and strip all four ends. At one end of the pair, connect one lead to pin 4 (NS) and the other lead to pin 5 (NS) of V-3. At the other end of this pair, connect one lead to pin 3 (S-1) and the other lead to pin 4 (S-1) of V-1.
- () Twist two 2 3/4" lengths of hookup wire together and strip all four ends. At one end of the pair, connect one lead to V-3 pin 4 (S-3) and connect the other lead to V-3 pin 5 (S-3). At the remaining end of this pair connect one lead to V-2 pin 4 (NS) and the other lead to V-2 pin 5 (S-1).

This completes the wiring of the filament circuit.

- () Observe the two deck ceramic switch carefully. Note the position of decks "A" and "B" and the numbering system for their terminals. See Figure 2.
- () Using bare wire, connect the five dummy (not connected to the rotor) lugs, B1, B2, B3, B4 and B5 together (NS).
- () Connect the $710\Omega \pm 1\%$ resistor between A1 and B1. Solder both ends.
- () Connect the $8K \pm 1\%$ resistor between A2 (NS) and B2 (NS).

- () Connect a 10 $\mu\mu\text{f}$ capacitor between A2 (S-2) and B2 (S-3).
- () Connect the 80K $\pm 1\%$ resistor between A3 (S-1) and B3 (S-2).
- () Connect the 800K 1% resistor between A4 (S-1) and B4 (S-2).
- () Connect the 8 megohm $\pm 1\%$ resistor between A5 (S-1) and B5 (NS).
- () Connect the 3600 Ω 1% resistor between A7 (S-1) and B7 (S-1).
- () Connect the 36 K $\Omega \pm 1\%$ resistor between A8 (S-1) and B8 (S-1).
- () Connect the 360 K $\Omega \pm 1\%$ resistor between A9 (S-1) and B9 (S-1).
- () Connect the 3.6 megohm $\pm 1\%$ resistor between A10 (S-1) and B10 (S-1).
- () Connect the 36 megohm $\pm 1\%$ resistor between A11 (S-1) and B11 (S-1).
- () Connect a 10 $\mu\mu\text{f}$ capacitor (this may be either a disc type or tubular type) between A6 (NS) and B6 (NS). Use sleeving.

This completes the wiring of the frequency multiplier switch.

- () With the tuning capacitor shaft facing toward you, using the two $\frac{3}{16}$ " 8-32 screws and #8 lockwashers, mount the trimmer mounting bracket at the left front side near TC-1. See Figure 3 and Figure 4.

- () Strip both ends of a 3" length of hookup wire. Connect one end to TC-1 (NS). See Figures 3 and 4.

- () Slip a 1 $\frac{3}{4}$ " length of insulated sleeving over one lead of a .1 μfd 200 V. capacitor and connect this lead to TC-1 (NS).

- () Connect a 1 $\frac{3}{4}$ " length of hookup wire to each of the two terminals on opposite ends of the dual air trimmer capacitor. Solder both connections. See Figure 3.

- () Mount the dual air trimmer in the $\frac{1}{4}$ " hole provided in the top of the trimmer mounting bracket with the unused lug facing out from the assembly.

- () Connect the 1 $\frac{3}{4}$ " lead from the front lug of the dual air trimmer to TC-1 (S-3).

- () Connect the 1 $\frac{3}{4}$ " lead from the rear lug of the dual air trimmer to TC-2 (S-1). See Figure 4.

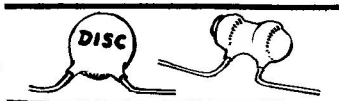
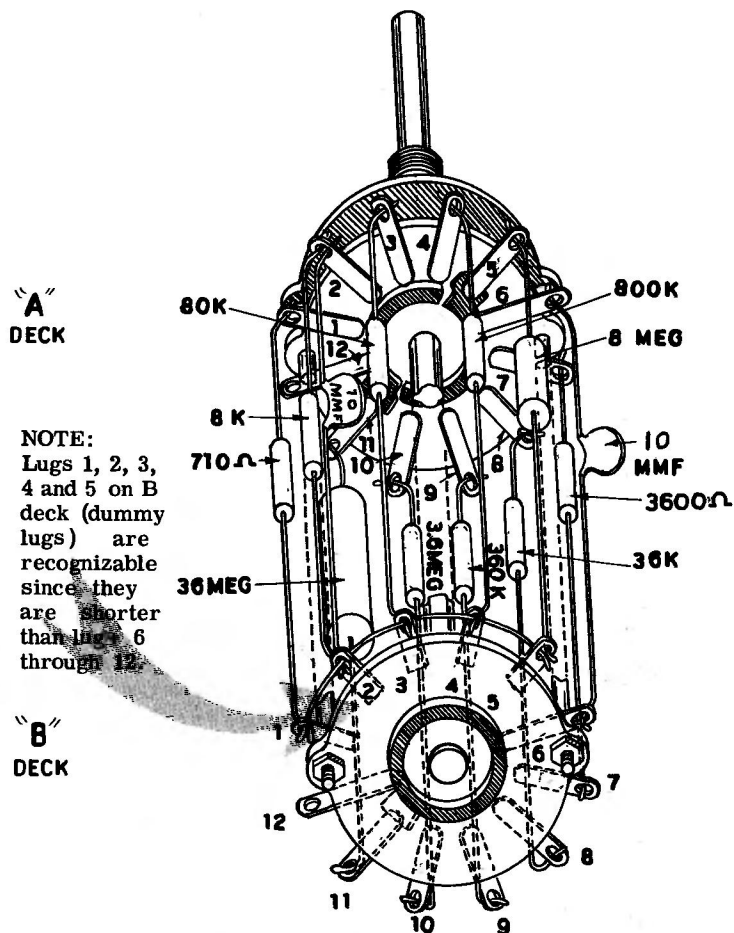

Figure 2

- () With the tuning capacitor shaft facing toward you, using the two $\frac{3}{16}$ " 8-32 screws and #8 lockwashers, mount the trimmer mounting bracket at the left front side near TC-1. See Figure 3 and Figure 4.

- () Strip both ends of a 3" length of hookup wire. Connect one end to TC-1 (NS). See Figures 3 and 4.

- () Slip a 1 $\frac{3}{4}$ " length of insulated sleeving over one lead of a .1 μfd 200 V. capacitor and connect this lead to TC-1 (NS).

- () Connect a 1 $\frac{3}{4}$ " length of hookup wire to each of the two terminals on opposite ends of the dual air trimmer capacitor. Solder both connections. See Figure 3.

- () Mount the dual air trimmer in the $\frac{1}{4}$ " hole provided in the top of the trimmer mounting bracket with the unused lug facing out from the assembly.

- () Connect the 1 $\frac{3}{4}$ " lead from the front lug of the dual air trimmer to TC-1 (S-3).

- () Connect the 1 $\frac{3}{4}$ " lead from the rear lug of the dual air trimmer to TC-2 (S-1). See Figure 4.

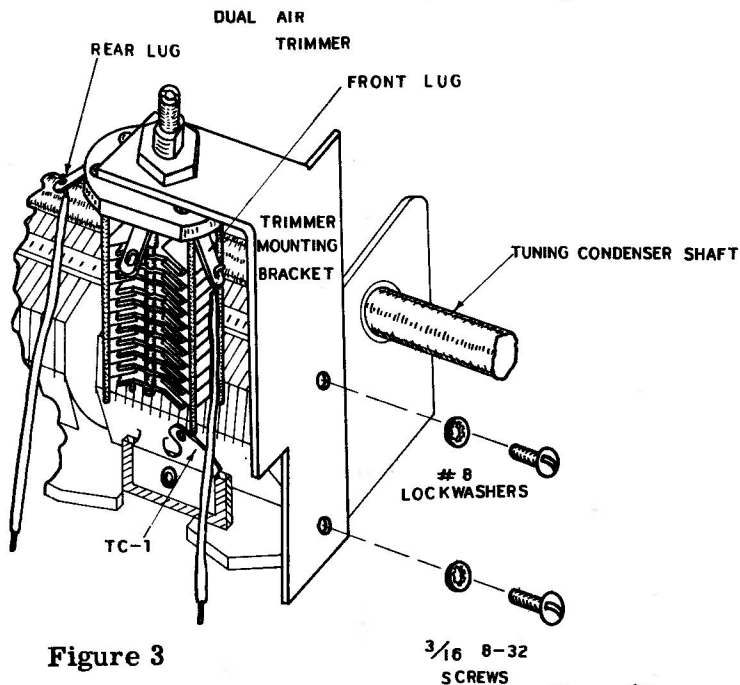

Figure 3

- () Connect a 3 1/4" length of hookup wire to TC-3 (S-1).
- () Connect a 5 1/2" length of hookup wire to TC-4 (S-1).
- () Mount the 7-35 $\mu\mu\text{f}$ ceramic trimmer on the bottom of the tuning capacitor insulator, using 6-32 hardware. Orient the slot so that it will face up through the large hole nearest the edge of the insulator; making sure at the same time that the positioning lug on the trimmer is inserted in the small hole provided for it before tightening.
- () Mount the tuning gang on the insulator using three 3/16" 6-32 screws in the holes marked for that purpose in Figure 1. Include solder lugs SL-1 and SL-2 under the two screws toward the chassis front, oriented as shown in Pictorial 1 on Page 9.
- () Connect a bare wire from SL-1 (S-1) to T-1 (NS).
- () Connect a 2 1/4" length of hookup wire to SL-2 (S-1).
- () Mount the frequency multiplier switch on the lower front shield with the dummy lugs on "B" deck facing away from the tuning capacitor. Use a lockwasher between the switch and shield and a nickel washer between the shield and control nut. See Pictorial 1 and Figure 5.
- () Connect the lead from SL-2 to A-6 (S-2) on the frequency multiplier switch.
- () Connect the lead from TC-1 to A-12 (NS).
- () Clip both leads of a 18 $\mu\mu\text{f}$ capacitor to 7/8" and connect it between T-1 (S-2) and A-12 (S-2). This will be the same type of capacitor as the 10 $\mu\mu\text{f}$ referred to on Page 13.
- () Connect the lead from TC-3 to B-6 (NS).
- () Connect a bare wire between B-12 (S-1) and T-2 (S-1).
- () Using 6-32 hardware, install the upper and lower rear shields with the flanges facing inward.
- () Connect a 4" length of hookup wire from B-5 (S-3) to the near grounded case lug of capacitor Z (NS). Route this lead tightly to the corner of the rear shield near the chassis.

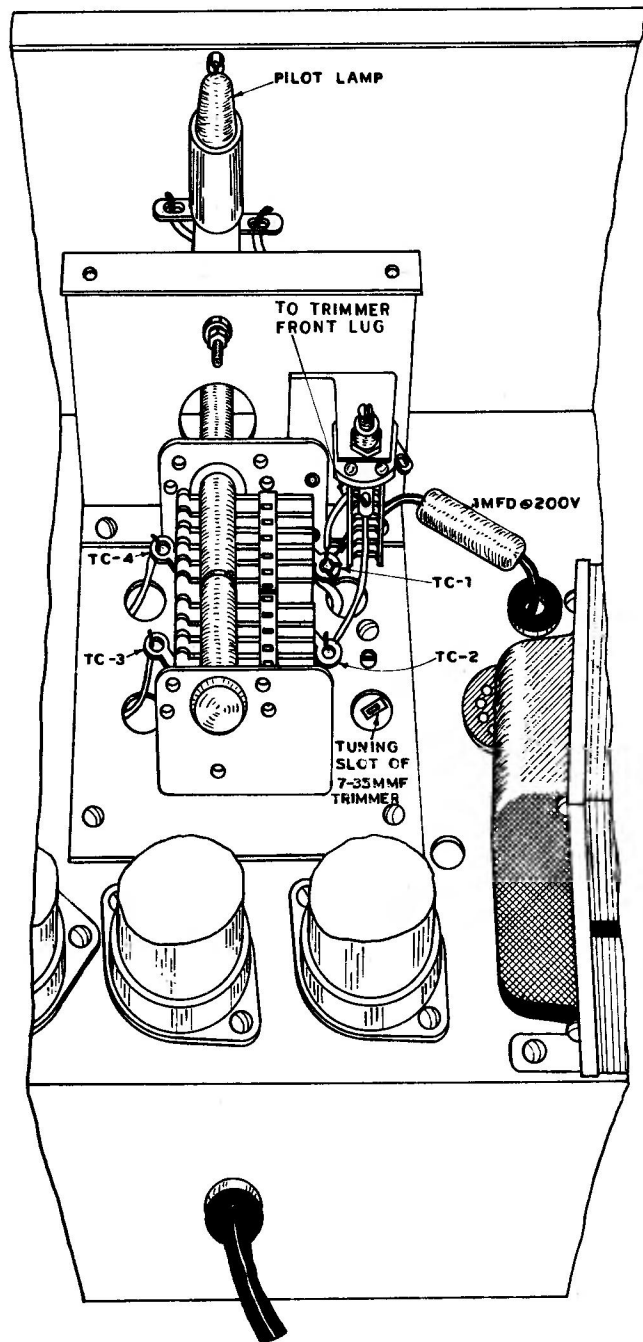
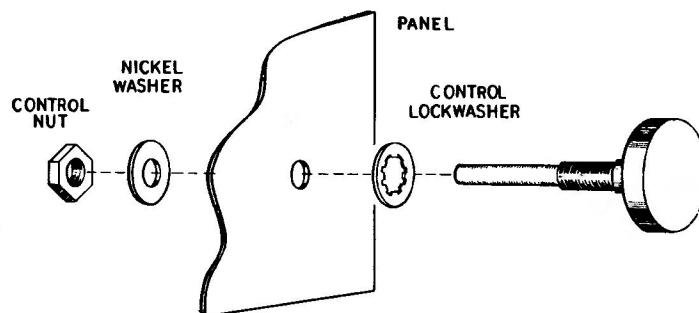

Figure 4



HOW TO MOUNT CONTROLS & SWITCHES.

Figure 5

- () Connect the long lead from TC-4 loosely to terminal "I" (NS). (It may be unhooked temporarily during a later step.) Route this lead close to the same corner as in the previous step.
- () Carefully bend pin 1 of V-1 out and down toward the chassis. Connect a length of hook-up wire from B-6 (S-3) to pin 1 of V-1 (S-1) routing it close to the corner as in the previous steps.

This completes the wiring of the frequency determining network.

- () Install the four binding posts on the front panel as shown using binding post base, insulators, solder lugs and 6-32 nuts. See Figure 6 and Pictorial 1.
- () Put the front panel in place and attach it to the chassis by mounting the 400 Ω control (with the on/off switch) in the position indicated on the diagram. As was done in frequency multiplier switch, use a lockwasher between the control and chassis and a nickel washer between the panel and the control nut. Do not tighten this control nut or the control nuts for the next three controls at this time.
- () In the same manner mount the following in the indicated positions, oriented as shown:
 - (a) Mount the three position switch (four terminals) in the square wave "range" position.
 - (b) Mount the four position switch (five terminals) in the sine wave range position, using a control solder lug in place of the lockwasher. Orient the lug straight down toward the bottom of the panel.
 - (c) Mount the 10K control in the sine wave "amplitude" position.
 - (d) Raise or lower the front panel position on the chassis until the tuning capacitor shaft is centered in the hole in the front panel. While holding the front panel in this position, tighten the control nuts on all four of the controls just installed.

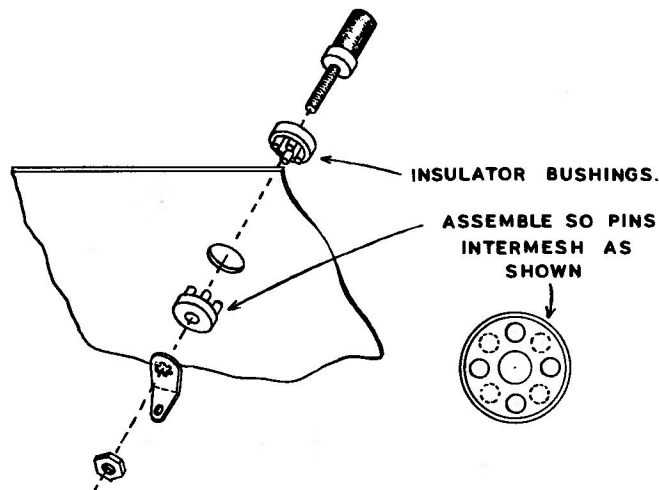

Figure 6

- () Install a #8 set screw in the insulated extension and in the pointer assembly. See Figure 7.
- () Slide the insulated extension on the tuning capacitor shaft with the small diameter end facing forward, till it is roughly 1/16" inside the upper front shield, and tighten the set screw. CAUTION: Do not let the set screw rub against the shield.
- () Slide the pointer assembly on the small end of the insulated extension till the pointer rests flat against the front panel. Do not tighten the set screw at this time.
- () Slide the large knob on the shaft in front of the pointer and tighten the knob set screw.
- () Insert the small red plug through the 1/8" hole in the top of the panel. From the rear of the panel, insert a screwdriver between the three segments of the plug and widen the opening so as to better admit light from the pilot lamp.

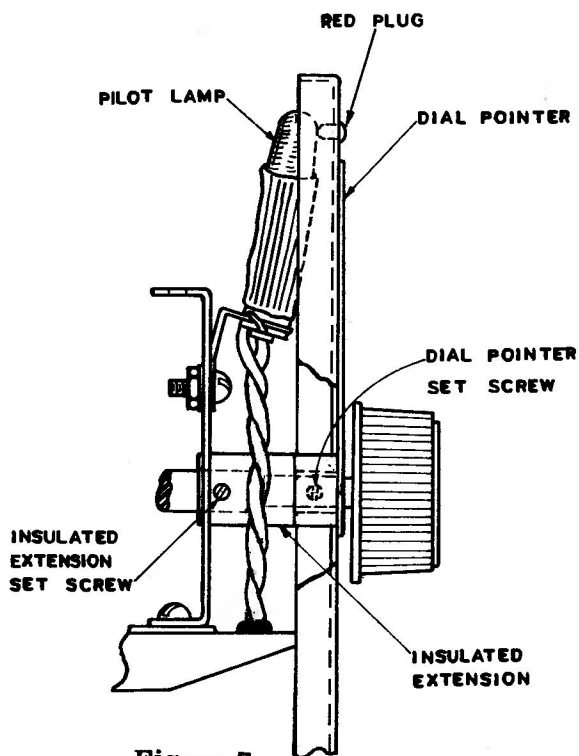
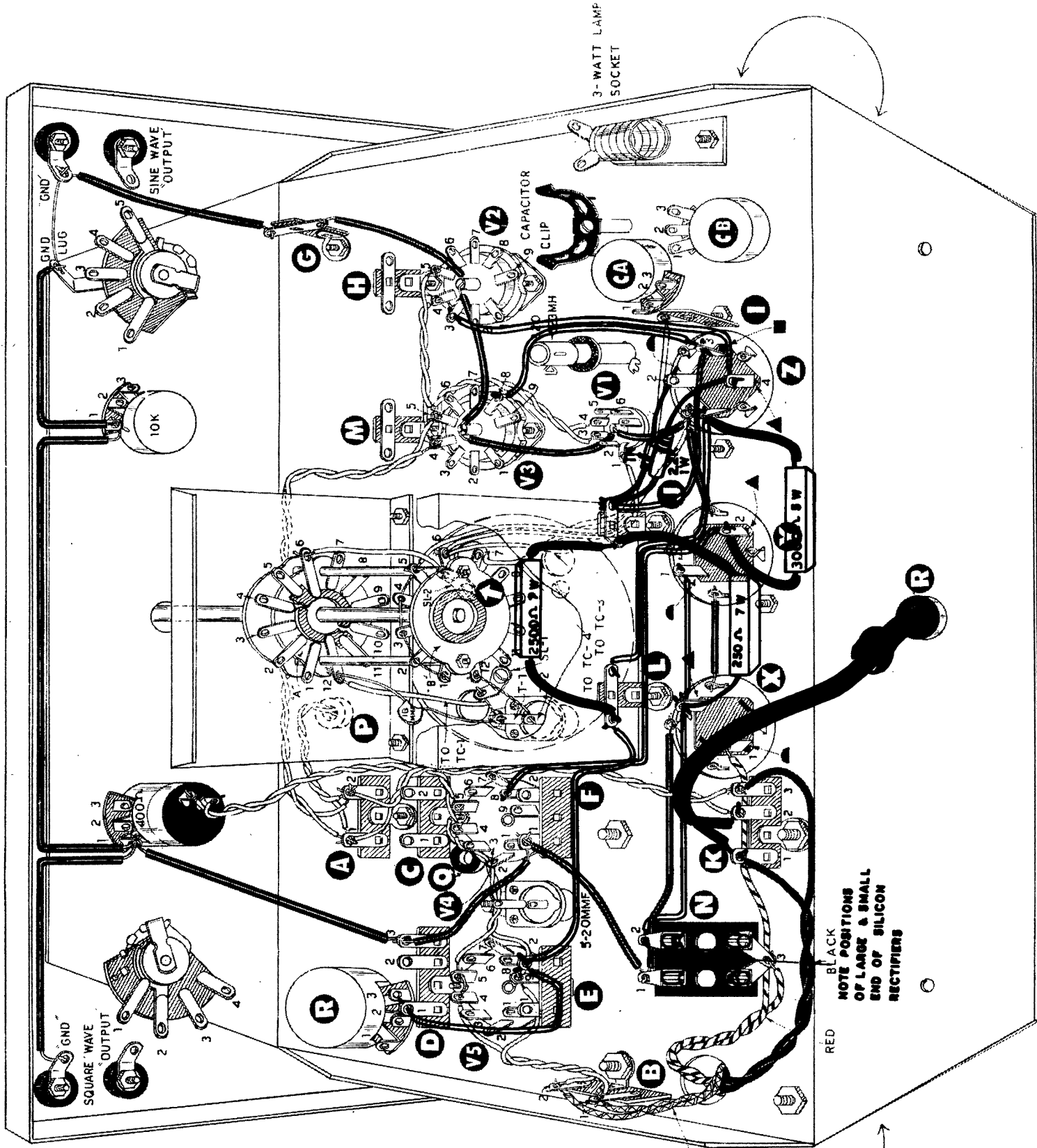

Figure 7

- () Install the pilot lamp in the pilot lamp socket. Wedge a screwdriver between the pilot lamp socket and the upper front shield. Push the pilot lamp socket outward till the lamp just touches the red plug.
- () Install one of the small knobs on each remaining shaft and temporarily tighten the set screws. Align the index on each knob by turning the shaft to its extreme counter-clockwise position, loosen the set screw, align the knob index with the extreme counter-clockwise index on the panel and retighten the set screw.
- () Connect a bare wire with insulated sleeving from the "ground" output post of the square wave section (NS) to pin 1 of the 400 Ω control (NS). Dress along the lower panel edge as shown in Pictorial 1, Page 9.
- () Connect a bare wire with insulated sleeving from pin 1 (NS) of the 400 Ω control to pin 1 of the 10K control (NS). Dress as in the previous step.
- () Connect a bare wire with insulated sleeving from pin 1 (S-2) of the 10K control to the control solder lug (NS) mounted under the five position switch.
- () Connect a bare wire from the control solder lug (S-2) to the "ground" output post (NS) of the sine wave section.
- () Connect a bare wire with insulated sleeving from the same "ground" output post (NS) to terminal "G" (NS).
- () Connect a bare wire with insulated sleeving from terminal "G" (NS) to the center post of tube socket V-2 (NS). Note that this center post can be turned to the desired direction. Route this lead between pins 5 and 6 of V-2.
- () Connect a bare wire with insulated sleeving from the center post of V-2 (NS) to the center post of V-3 (NS). Route this lead tight to the chassis between pins 2 and 3 of V-2, and between pins 7 and 8 of V-3.
- () Connect a bare wire with insulated sleeving from the center post of V-3 (S-2) to the center post of V-1 (NS). Route this lead between pins 1 and 9 of V-3 and between pins 2 and 3 of V-1.
- () Connect a bare wire with insulated sleeving from the center post of V-1 (S-2) to the nearest case lug of capacitor "Z" (NS).
- () Connect a bare wire with insulated sleeving from this same capacitor case lug (S-3) to the nearest case lug of capacitor "Y" (S-1).
- () Connect a bare wire with insulated sleeving between the two closest case lugs of capacitors X (S-1) and Y (S-1).
- () Connect a bare wire with insulated sleeving from the case lug nearest the front panel of capacitor "X" (S-1) to N-1 (NS).
- () Connect a bare wire with insulated sleeving from N-1 (S-2) to F-1 (NS).
- () Connect a length of hookup wire from F-1 (NS) to D-3 (NS). Route the lead between V-4 and the variable trimmer capacitor.
- () Connect length of hookup wire from D-3 (NS) to lug #1 of the 400 Ω control (S-3).

This completes the wiring of the ground bus circuit.



PICTORIAL 2

SL-2 MOUNTED ON INSULATOR

BLACK
 RED
 NOTE POSITIONS OF LARGE & SMALL END OF SILICON RECTIFIERS

- () Twist together two segments of hookup wire to a length of approximately 8" and strip both leads at one end. Solder one of these leads to each of the lugs on the rear of the 400Ω square wave amplitude control.
- () Route this pair tight to the chassis between V-4 and the "frequency selector switch" shielding, terminating them at terminal strip "K". Clip off any excess wire and connect one lead to K-2 (NS) and the other lead to K-3 (S-2).

Refer to Pictorial 2 for the following connections:

- () Connect a length of hookup wire from X-2 (NS) to Y-1 (S-1).
- () Connect a length of hookup wire from X-2 (NS) to N-2 (S-1).
- () Using insulated sleeving connect a 250Ω, 7 w. resistor between X-2 (S-3) and terminal strip J (NS). If necessary, using long nose pliers, bend the lug of terminal J as shown in the diagram so that the resistor lead will reach.
- () Connect a 3K, 5 w. resistor between Z-1 (NS) and Y-2 (NS). Place the resistor body exactly as it is shown in the diagram so that the 40 μfd 6CB6 screen capacitor to be installed in a later step will fit beside it as shown in Pictorial 3, Page 20.
- () Connect a length of hookup wire from terminal J (NS) to Z-3 (NS).
- () Connect a 1 KΩ, 1/2 w. resistor from terminal "J" (NS) to Z-2 (NS).
- () Connect a 2.2 KΩ 1 w. resistor from terminal "J" (NS) to Z-4 (NS). Bend terminal Z-4 slightly forward with long nose pliers.
- () Connect a length of hookup wire from Z-1 (S-2) to terminal "L" (NS).
- () Connect a length of hookup wire from terminal "L" (NS) to terminal lug "E-2" (NS).
- () Connect a length of hookup wire from terminal lug E-2 (NS) to terminal lug D-1 (NS). Route this lead around the outside of V-5.
- () Connect a length of hookup wire from Y-2 (S-2) to V-4, pin 8 (NS).
- () Using insulated sleeving connect a 2.5K, 7 w. resistor from terminal "J" to terminal "L". Solder all connections on terminal J (S-5) and terminal L (S-3). Orient the resistor body as shown in the diagram.
- () Connect a length of hookup wire from Z-4 (S-2) tight to the chassis between the control "CA" and the coil mounting hole, to pin 3 of V-2 (NS).
- () Connect a length of hookup wire from Z-3 (S-2) routed as in the previous step, to pin 8 of V-3 (S-1).

Refer to Pictorial 3 for the following:

- () Connect a 3.3 KΩ, 1 w. resistor from lug #3 of control CB (S-1), around behind the control to the closest ground lug on capacitor "Z" (S-1). Use sleeving on both leads.
- () Connect a .001 μfd disc capacitor between pin #8 of V-2 (S-1) and the center ground lug of V-2 (NS). Use sleeving.
- () Strip one end of a length of hookup wire to approximately 1". Insert this through pin #7 of V-1 (NS) to pin #2 of V-1 (S-1). Use insulated sleeving between the two pins. Connect the other end of this wire to lug #1 of control "CA" (S-1).

- () Connect a bare wire between lugs #2 (NS) and 3 (S-1) of control CA.
- () Connect a 33Ω 1/2 w. resistor between lug #2 (S-2) of control CA, and lug #1 (NS) of control CB.
- () Loosen the mounting screw for terminal "I", and temporarily turn the terminal 30 degrees to 45 degrees clockwise. Place the $40\ \mu\text{fd}$, 350 v. electrolytic capacitor in the corner of the chassis behind capacitor lug Z-4, with the plus end facing control "CB". Z-4 should be bent just enough so that the capacitor will sit snugly in the corner behind it. Turn terminal "I" back again until it rests against the capacitor and tighten the mounting screw.
- () Using insulated sleeving, connect the negative lead of this capacitor to pin #7 of V-1 (S-2). Route the lead under the 2.2K and 1K resistors from terminal "J".
- () Using insulated sleeving, connect the positive lead of this $40\ \mu\text{fd}$ capacitor to pin #6 of V-1 (NS). Route the lead around terminal "I" as shown in the diagram.
- () Mount the 220-525 μh RF choke in the blank hole in the chassis between V-1 and control "CA". Orient one lug to face toward pin #5 of V-1, and the other lug toward capacitor lug Z-2. Press the choke firmly through from the bottom of the chassis till the holding lugs snap into place. Make sure the mounting lug doesn't short to terminal #1 of control "CA".
- () Connect an $8.2\ \text{K}\Omega$, 1/2 w. resistor between V-1 Pin 6 (S-2) and capacitor lug Z-2 (NS).
- () Connect a length of bare wire from pin #5 of V-1 (S-1) to the RF choke lug directly above it (NS).
- () Connect a 5.6K, 1/2 w. resistor from the other lug on the RF choke (S-1) to Z-2 (S-3).
- () Connect a 22K, 1/2 w. 5% resistor from lug #1 (S-2) of control "CB" to terminal "I" (NS).
- () Connect a length of hookup wire from lug #2 (S-1) of control "CB" to the near lug of the 3 watt lamp socket (S-1).
- () Connect the negative (-) end of a $40\ \mu\text{fd}$, 150 v. capacitor to the other lug of the 3-watt lamp socket (S-1). Connect the positive end (+) of this capacitor to terminal "H" (NS), using sleeving if the lead is over 1/2" long.
- () Connect a $5\ \text{K}\Omega$, 7 watt resistor between terminal H (NS) and terminal "G" (NS).
- () Using insulated sleeving, connect a 100K, 1/2 watt resistor from pin #4 of V-2 (NS) to the center ground post of V-2 (S-4). Route the resistor and leads around the socket and near the chassis. Using insulated sleeving, run the grounded lead up to the ground lug between pins #7 and #8.
- () Using insulated sleeving, connect a $220\ \text{K}\Omega$, 1/2 watt resistor from pin #4 of V-2 (S-3) to pin #6 of V-3 (NS). Route the resistor body close to the chassis.
- () Connect a bare wire with sleeving between pin #3 (S-2) and pin #6 (S-1) of V-2.
- () Connect a bare wire with sleeving between pin #3 (S-1) and pin #6 (S-2) of V-3.
- () Connect a length of hookup wire between pin #7 (S-1) of V-2 and terminal H (NS).
- () Connect a 68Ω , 1/2 watt resistor from pin #1 (NS) of V-2 to terminal "H" (NS).
- () Connect a 1 megohm, 1/2 watt resistor from pin #2 (NS) of V-2 to terminal "H" (NS).

- () Using insulated sleeving connect a 51Ω , 1/2 watt resistor between pin #1 (S-1) and pin #7 (NS) of V-3. Route this resistor around the outside of the socket with its body near pin #9.
- () Connect a length of hookup wire from pin #7 (S-2) of V-3 to terminal "M" (NS).
- () Connect a 1 megohm 1/2 watt resistor between pin #2 (NS) of V-3 and terminal "M" (NS). Place the resistor body as shown in the pictorial.
- () Connect a $5\text{ K}\Omega$, 7 watt resistor between terminal "M" (NS) and terminal "G" (NS). Place the resistor body as shown in the pictorial.
- () Using insulated sleeving, connect a $2.0\ \mu\text{f}$, 200 v. capacitor from pin 2 of V-3 (S-2) to terminal "H" (S-6). Place the capacitor body between terminal "M" and the front panel as shown in the pictorial. NOTE: When soldering terminals "M", "H", and "G", be sure that all the connections on both sides are soldered.
- () Using insulated sleeving, connect the positive end of a $40\ \mu\text{f}$, 150 v. capacitor to terminal "M" (S-4) and connect the negative end to lug #3 (S-1) of the 10K front panel control. Place the capacitor body between the $2.0\ \mu\text{f}$ capacitor and the front panel.
- () Connect a length of hookup wire from lug #2 (S-1) of the 10K front panel control to lug #2 (NS) of the five lug sine wave range switch.
- () Connect a 6.2 K , 1/2 watt resistor from lug #2 (S-2) of this switch to lug #3 (NS).
- () Connect a 6.2 K , 1/2 watt resistor from lug #3 (NS) to lug #4 (NS). Connect a 6.2 K , 1/2 watt resistor between lugs #4 (NS) and lug #5 (NS).
- () Connect a 750Ω , 1/2 watt resistor from lug #3 (S-3) to the "Ground" output post (NS).
- () Connect a 750Ω , 1/2 watt resistor from lug #4 (S-3) to the "Ground" output post (S-4).
- () Connect a 680Ω , 1/2 watt resistor from lug #5 (S-2) to terminal "G" (S-5). Be sure and solder all connections on both sides of terminal "G".
- () Connect a length of hookup wire from lug #1 (S-1) of this 5 lug switch to the "Sine wave output post" (S-1).
- () Connect a $4.0\ \mu\text{f}$, 200 v. capacitor from terminal "I" (S-3) to pin #1 (S-2) of V-2. Place the capacitor body in the capacitor clip next to control "CA".
- () Using sleeving, connect a $1.0\ \mu\text{f}$, 200 v. capacitor from pin #2 (S-2) of V-2 to the RF choke lug (S-2) directly above pin #5 of V1.

This completes the wiring of the sine wave section.

Refer to Pictorial 4 for the following:

- () Connect a bare wire from lug #1 (S-1) of the 4 lug square wave range switch, to the square wave output post (S-1).
- () Connect a 56Ω , 1/2 watt resistor from lug #2 (NS) of this switch to the "Ground" post (NS).
- () Connect a 510Ω , 1/2 watt resistor from lug #2 (S-2) to lug #3 (NS).
- () Connect a 62Ω , 1/2 watt resistor from lug #3 (NS) to the "ground" post (S-3).
- () Connect a 510Ω , 1/2 watt resistor from lug #3 (S-3) to lug #4 (NS).

- () Connect a length of hookup wire from lug #4 (S-2) of this switch to lug #2 of the 400 Ω control (S-1).
- () Connect a bare wire between pin #9 (S-1) and pin #8 (NS) of V-4.
- () Connect a bare wire with sleeving between pin #3 (S-1) and pin #8 of V-4 (S-3). Connect this wire between the top holes of each pin.
- () Connect a bare wire with sleeving between the top holes of pin #3 (S-1) and pin #8 (NS) of V-5.
- () Slip 1 1/2" of sleeving over the free end of the .1 μ fd, 200 v. capacitor connected to terminal TC-1 of the tuning capacitor on the top of the chassis. Route the connected lead of this capacitor as close as possible to the lower front corner of the shield (as shown in Pictorial 6 on Page 28. Insert the free end down through grommet "Q" and connect it to V-4 pin #2 (NS).
- () Connect a 100 K Ω , 1/2 watt resistor from pin #2 (S-2) of V-4 to terminal "C-1" (NS). Route this resistor outside the tube socket as shown in the pictorial.
- () Using insulated sleeving, connect a 1 K, 1/2 watt resistor from pin #1 (NS) of V-4 to terminal "C-1" (NS). Place the body of the resistor over the tube socket with the lead to "C-1" passing between or over pins #3 and #4 as shown in the pictorial.
- () Connect a 1 megohm, 1/2 watt resistor from pin #7 of V-4 (NS) to terminal C-2 (NS). Be careful that this resistor is not mounted too far out from the socket so as to interfere with the lower shield cover to be installed later.
- () Connect a bare wire from pin #6 (S-1) of V-4 to terminal C-2 (NS).
- () Connect a 3" length of hookup wire from terminal C-2 (S-3) to lug #3 (S-1) of the 400 Ω square wave amplitude control. Loop the slack in the wire out and away from the on-off switch on the rear of the control.
- () Connect a 10 K Ω , 1/2 watt resistor from terminal "C-1" (S-3) to terminal "D-3" (NS).
- () Connect a bare wire from pin #7 (NS) of V-5 to the closest lug (NS) of the 5-20 μ μ f trimmer capacitor. CAUTION: Make sure this wire doesn't short to the trimmer mounting lug.
- () Connect a bare wire from the remaining lug (S-1) of the trimmer capacitor to terminal F-1 (NS).
- () Connect a 10 K Ω , 1 watt resistor from pin #8 (S-2) of V-5 to terminal F-1 (S-4). Place the resistor body across the trimmer capacitor.
- () Connect a 100 K Ω , 1/2 watt resistor from D-3 (NS) to the trimmer capacitor lug (S-2) that is connected to pin #7 of V-5.
- () Using sleeving, connect a 47 K Ω , 1/2 watt resistor from lug #3 (S-1) of control "R" to terminal D-3 (S-5).
- () Connect a 3.3 K Ω , 1/2 watt resistor from pin #6 (NS) of V-5 to terminal D-2 (NS).
- () Using insulated sleeving connect a 470 K Ω , 1/2 watt resistor from lug #2 (S-1) of control "R" to pin #2 (NS) of V-5.
- () Connect a 100 K Ω , 1/2 watt resistor from lug #1 (S-1) of control "R" to terminal D-1 (NS).
- () Connect the 30 microhenry RF choke (the smaller of the two) between terminals D-1 (S-3) and D-2 (S-2).

- () Connect a 220 K Ω , 1/2 watt resistor from pin #1 (NS) to pin #7 (NS) of V-5.
- () Connect 10 μf disc type capacitor from pin 1 (NS) to pin #7 (S-3) of V-5.
- () Connect a 4.7 K Ω 1/2 watt resistor from pin #1 (S-3) of V-5 to E-1 (NS).
- () Connect the remaining RF choke from E-1 (S-2) to E-2 (S-3). See Pictorial 5.
- () Cut both leads of a .1 μf d, 200 v. capacitor to a 1" length. Using insulated sleeving, and mounting the capacitor straight above the sockets, connect one lead to V-4 pin #1 (S-2). Connect the other lead to V-5 pin #2 (S-2).
- () Cut both leads of a 2.0 μf d, 200 v. capacitor to 1 1/2". Using insulated sleeving, connect one lead to pin #7 of V-4 (S-2). Connect the other lead to pin #6 of V-5 (S-2). See Pictorial 5.
- () Insert the line cord through the grommet in the back of the chassis and tie a knot in it for strain relief about 4" to 4 1/2" from the stripped ends. Connect one lead to K-1 (S-2) and the other lead to K-2 (S-2).

This completes the wiring of the instrument. At this time, a little inspection of the work is in order. First, make sure we haven't wired your finger, your wife's tablecloth or the dogs tail into the circuit.

Next, shake out all loose solder bits and wire clippings. Inspect the wiring carefully for any shorts (bare lead touching metal parts or components touching moving parts) and inspect each connection for good soldering. This being done and meeting approval, we plunge on.

- () Install the lower shield cover. (This is the one without the large holes.) Align the cut corner of the shield near V-1 so as to let the leads pass through to the multiplier switch. Tighten it in place with four sheet metal screws. Make sure that pins #1 and #2 of V-1, and pins #1, #2, and #3 of V-3 DO NOT SHORT against the shield cover.
- () Install the upper shield cover. See Pictorial 6, Page 28. Mount it so that the two alignment holes are above the two variable trimmers. Tighten it in place with four sheet metal screws.
- () Install the tubes in their sockets:

V-1 = 6CB6	V-2 = 6CL6	V-3 = 6CL6
V-4 = 6AW8	V-5 = 12AT7	
- () Install the 3-watt lamp in its socket.
- () Install the silicon rectifiers in the socket, being careful to mount them exactly as shown in Figure 8 and Pictorial 2 on Page 17.
- () Cut the fibreglas tubing to 1 1/8" and slide it over the pilot lamp. Slide it down until it rests against the solder lugs.

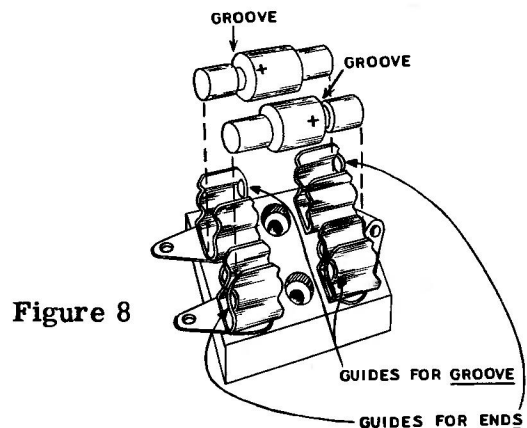

Figure 8

This completes the wiring of the instrument.

- () Prepare the cabinet by installing the handle with #10 self tapping screws and by pushing the four rubber feet into the four holes in the bottom. Moistening the rubber feet will facilitate installation. Refer to Figure 9.

INSTALL FEET AS SHOWN

Figure 9

See Figure 10 for the following:

- () Cut away 3/4" of outer insulation on both ends of the 3-foot length of coaxial cable. At each end, push the braid back until a bulge develops near the end of the outside insulation. Bend

the wire over double at the bulge point, separate the braid strands, and pull the inner conductor through the hole. Pull lightly on the separate braid ends to tighten them into leads. Strip off 1/4" of insulation from the center conductor on each end.

- () Install two banana pins through the mounting holes of a terminal half-shell with a fiber washer (red or black) on the outside and with a #6 solder lug and 6-32 nuts on the inside. Install the red fiber washer and the black fiber washer on the same sides as shown in Figure 10.
- () Connect the center conductor of the cable to the solder lug which has been color coded red by the fiber washer (S-1).
- () Connect the braided shield to the other solder lug (S-1).
- () Install the other cover of the terminal half-shell with a long 4-40 screw and nut.
- () Install the two binding post bases, with #6 solder lugs and 6-32 nuts, in the other terminal half-shell.
- () Install a red binding post cap on one base and a black binding post cap on the other.

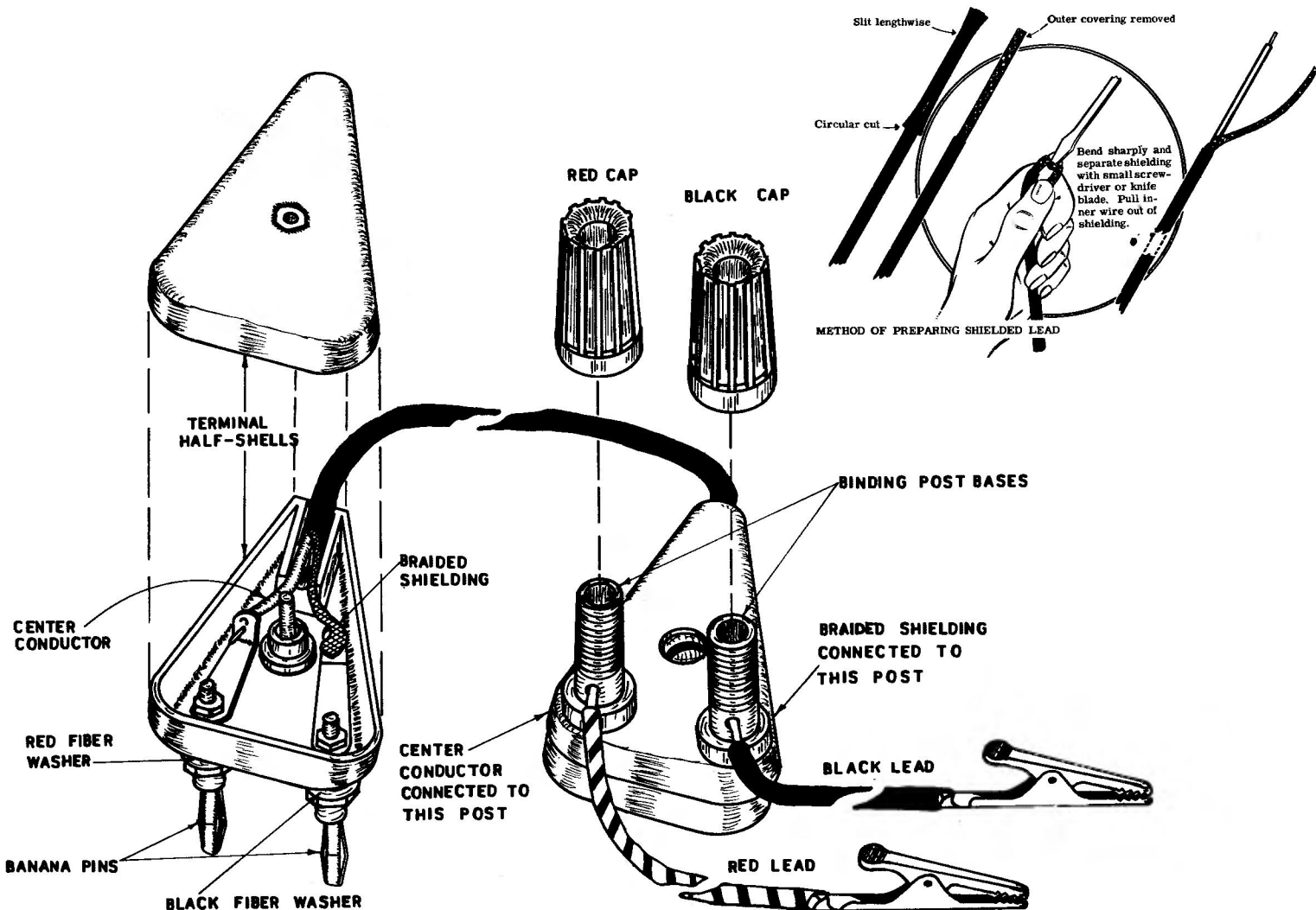

Figure 10

- () Connect the center conductor of the other end of the coaxial cable to the solder lug on the red binding post (S-1).
- () Connect the twisted braid to the solder lug on the black binding post (S-1).
- () Install the cover of this half-shell with a long 4-40 screw and nut.
- () Strip about 3/8" of insulation off all four ends of the 4" lengths of red and black test leads. Tin all four ends.
- () Connect an alligator clip to one end of each lead by bending the ears over the tinned lead with a pair of long nose pliers. Solder the leads to the "bent over ears".
- () Insert the other end of the black lead through the hole under the black binding post cap. Tighten the cap.
- () Insert the other end of the red lead through the hole under the red binding post cap and tighten the cap.

PANEL CONTROLS

You will find the front panel controls of your sine-square generator to be divided into three groups.

The "frequency" and "frequency multiplier" is the group which determines the frequency for both sine and square waves, hence it is in the center of the panel. Output frequency is determined by multiplying the "frequency (cps)" setting times the "frequency multiplier". The outer dial calibration is used for the "X-1", "X10", "X100" and "X1K" positions, and the inner calibration is used for "X10K" only.

On the right side of the panel, under the "output" and sine wave drawn on the panel are all the controls and connectors for the sine wave output; the output posts, the output "range" switch, and the output "amplitude". The "range" switch sets the maximum voltage at the output posts, and the "amplitude" control allows this voltage to be varied from the maximum down to zero. The voltages indicated on the range control are rms volts.

On the left side of the panel, under the "output" and square wave drawn on the panel, are all the controls and connectors for the square wave output. At the extreme left side of the panel are the output posts. Next is the "range" switch which sets the maximum peak to peak volts at the output posts, and next to this is the amplitude control to vary the output voltage from maximum down to zero.

CALIBRATION AND ADJUSTMENT

Plug the line cord into a 115 v. 50-60 cycle outlet. Do not plug into a 25 cycle or DC outlet since this would harm the power transformer. Turn the power switch (on the square-wave amplitude control) on and watch to see that the tubes and pilot lamp light. If they don't light, check the filament circuit for errors.

If needed, adjust the pilot lamp slightly to the right, or left so as to admit the maximum light to the red button on the panel.

CAUTION: Be careful not to touch the metal socket next to the bulb or the solder lugs since they are biased at +75 volts DC.

SINE WAVE SECTION: The instruments needed to calibrate the sine wave section are an ohm-meter, and an AC vacuum tube voltmeter, such as the Heathkit Model AV-2 or 3. The AC range of a standard vacuum tube voltmeter (the properly constructed and calibrated Heathkit Models V-6, V-7 and later models are satisfactory) is sufficient for the AC if it has a fairly wide frequency response. It should have a flat response from at least 60 cycles to 2000 cycles and have a usable indication at 20 cycles. A flat response from 20 cycles to one megacycle or better would be perfect. The frequency response of an instrument can usually be found in almost any descriptive literature about the instrument.

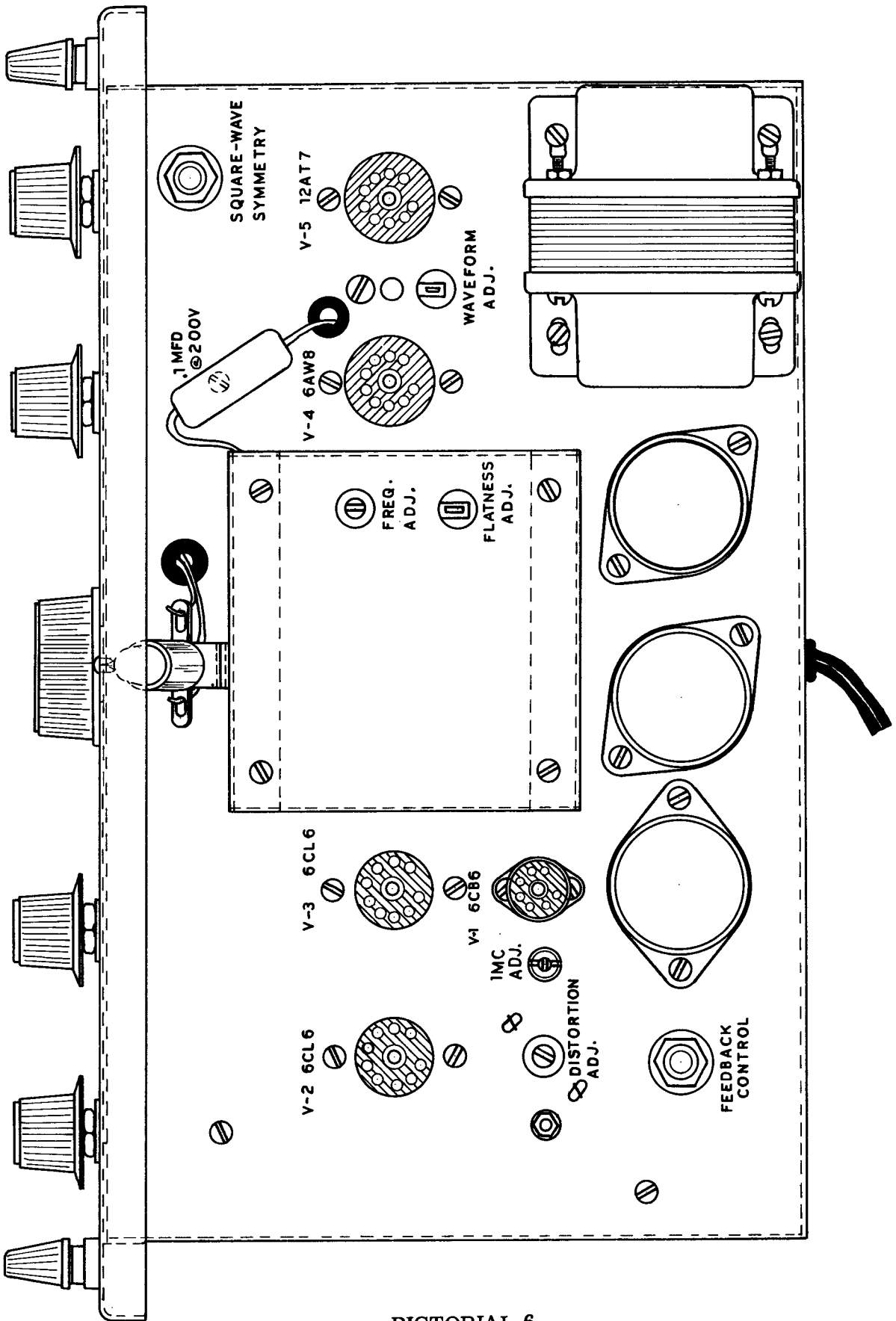

PICTORIAL 6

Turn the power off for the following adjustments: Remove the 6CB6 (V-1) from its socket and connect an ohmmeter between lug #1 of control "CB" and pin #2 or #7 of V-1. Using a screwdriver, adjust the "distortion adjustment" for a reading of 130Ω on the ohmmeter. Remove the ohmmeter and plug the 6CB6 back in its socket.

On the chassis:

- Set the feedback control to the full clockwise position;
- Set the "square wave symmetry" control to approximately the center of its travel;
- Set the "1 MC adj." so that about 1/2" of the adjustment screw is visible.
- Set the "frequency adjust" variable capacitor to the center of its range.

Set the front panel controls as follows:

- Frequency.....Full counter-clockwise
- Frequency multiplier.....X10
- All others.....Full clockwise (plus power switch on)

Connect the AC Voltmeter to the sine wave output terminals and set it to a 15 v. or 30 v. range. Turn the feedback control counter-clockwise until the AC Voltmeter reads 10 volts rms. At this point allow the instrument to warm up for 15 to 30 minutes before proceeding.

The instrument having warmed up, if the output indication on the meter has changed, readjust it to exactly 10 volts.

NOTE: For the adjustments inside the shield, a non-metallic alignment tool (available for about 50 cents at any electronic distributors) is preferable, but a small screwdriver (insulated with tape) can be made to work, though it may occasion a loss in accuracy.

With the tuning capacitor plates fully meshed, loosen the insulated extension, and retighten its set screw so it will be aimed toward the symmetry control. Align the pointer directly over the marker denoting the end of the calibrated scale, below the number "20", and tighten the set screw enough to hold the pointer in place. Turn the frequency control until the pointer is over the "200" marker.

Adjust the 7-35 μμf trimmer, "flatness adj." (through the rear hole in the top shield) for exactly the same reading (10 volts) that was set at the low end of the band. If you should be using a metal screwdriver for this adjustment, note whether the 10 volt reading changes when the screwdriver is removed from the shield. If it does change, make sure that the meter reads 10 volts when the screwdriver is not inside the shield.

Turn the frequency control back to the full counter-clockwise position and change the frequency multiplier to the "X1" position. Turn the oscillator off for a moment, remove the ground lead of the AC Voltmeter from the "ground" post, and connect it to one of the pilot lamp solder lugs. Make sure the ground lead does not touch the chassis or the pilot light mounting strap, since this could short out the power supply. To be safe it might be well to wrap the ground clip in insulated tape. Connect the "hot" lead of the "AC Voltmeter" to the red square wave output post, turn the oscillator back on, and adjust the voltmeter to a scale where there is a reading in the upper half of the meter scale. Very slowly tune the frequency through the region around "60" on the dial. Notice that somewhere near "60" the pointer of the meter will go through a period of oscillation. Tuning very slowly and carefully you will notice that the oscillation will start with the pointer moving quickly; gradually it will move more slowly and with wider swings until it reaches a maximum, from where it will once again become quicker and smaller as before, until the pointer once more becomes stationary.

Tune the "frequency" control to the center of this period of oscillation (near 60 cycles) where the pointer should just about cease its motion completely. This is the point where the 60 cycles of the oscillator has been matched against the accurately controlled 60-cycle power line frequency; with the result that we now have the exact setting of 60 cycles on the tuning capacitor. The correct term for this operation is "zero beating".

Being careful not to move the setting of the tuning capacitor itself, loosen the set screw on the insulated extension, place the pointer over "60" on the outer scale, and tighten the set screw.

Tune the "frequency" control to 180. Adjust the "frequency adjust" (through the front hole in the top shield) for the correct frequency in the same manner that the 60-cycle point was found at the lower end of the scale; in this case, adjust until the third harmonic of the 60-cycle power line (180 cycles) "zero beats" against the 180 cycles of the oscillator. If a "zero beat" cannot be found at 180 cycles, switch the "AC Voltmeter" ground lead to the other lug on the pilot lamp.

Depending on how much capacity you have added or subtracted from the oscillator circuit by this adjustment, you may find in rechecking that the 60-cycle point has moved slightly. If this is the case, it may be desirable to repeat the calibration, first, at the 60-cycle point, and then at the 180-cycle point on the dial.

At this point you may find that pointer, when turned to either maximum position, will not stop exactly at the markers denoting the end of the calibrated scale. This is of no consequence and is due to slight differences in the values of the components from their nominal values.

The last chore to be taken care of in this section is the "1 mc adj." which adjusts the 1 mc signal up to the 10-volt level with the lower frequencies. To do this, of course, we will need an indicating device (meter or oscilloscope) which will give us a true indication at this frequency. An AC voltmeter with a flat response to 1 mc or the AC volts position of the Heathkit Model V-7 Vacuum Tube Voltmeter will work well. An oscilloscope with a 1 mc or better, vertical amplifier response, such as the Heathkit Models O-10 and O-11 can also be used.

Turn the frequency multiplier to the X10 K position and the frequency dial to 100 on the inner scale. Connect the meter or oscilloscope to the sine wave output terminals (both the "hot" lead and ground lead). If a meter is used, adjust the "1 mc adjust" for an indication of 10 volts. If an oscilloscope is used, adjust the "1 mc adjust" for the same size sine wave on the cathode ray tube that is found on the "X10" and X100 ranges. If any difficulty should be encountered in bringing the output up to the 10 volt level, move the 40 μ fd, 350 v. capacitor (behind capacitor lug Z-4) out slightly from the corner of the chassis. Moving the 40 μ fd capacitor connected to the 3 watt lamp, may also have the same effect.

This completes the calibration and adjustment of the sine wave section, unless you should have access to a distortion meter, and wish to adjust the oscillator for minimum distortion with the particular 6CB6 in your circuit. Since the average vacuum tubes are generally constructed by production methods, the small differences from tube to tube are bound to show up in a critical application such as this.

Connect both the AC voltmeter and the distortion meter to the sine wave output terminals, and set the oscillator to 10 volts output at 150 cycles. Adjust the distortion meter to read the percent of distortion. Note that the "distortion adj." changes the operating point of the 6CB6 and therefore will also increase or decrease the 10-volt output somewhat. Turn the "distortion adjust" a small fraction of a turn in whichever direction decreases the "percent of distortion" and correct any amplitude change in the 10-volt output with the "feedback control". By repeating this process a number of times, a point will be found where no further decrease in distortion is possible.

This completes the sine wave calibration.

SQUARE WAVE SECTION: To properly adjust the square wave, an oscilloscope should be used so that the wave form can be observed while the adjustments are being made. If a "scope" is not available, leave the "square wave symmetry" in approximately the center of its travel, and adjust the "waveform adjust" as follows. Turn the "waveform adjust" so that the slot is parallel to the rear of the chassis.

With an oscilloscope, set the oscillator frequency to 2000 cycles and connect the "scope input leads" to the "square wave" output terminals. Adjust the "square wave symmetry" so that in one complete square wave cycle, the positive and negative halves of the waveform are of equal size. Change the frequency to 200 kc or more, and turn the "waveform adjust" for the sharpest rise time and sharpest corners on the square wave. If your oscilloscope will not reproduce this high a frequency satisfactorily, make this adjustment as was described in the previous paragraph.

This completes the calibration procedure for the square wave section. Install the generator in the cabinet and fasten with the two #6 sheet metal screws through the rear of the cabinet into the rear chassis apron.

IN CASE OF DIFFICULTY

If this instrument fails to operate as specified, proceed as follows:

1. Read the circuit description to understand the principles of operation, and recheck the calibration procedure.
2. Check the wiring over carefully step-by-step, or if possible have a friend check it with you. Even the most experienced electronic engineers and technicians have found that after working on an instrument for a long time, they will repeatedly overlook a simple mistake, where a fresh outlook by someone else will find it immediately.
3. Check for visual malfunctioning, such as resistors overheating and discoloring, wires touching metal chassis parts, etc.
4. Check the tubes.
5. Bearing in mind the principles of operation for each circuit, check the voltages at each tube socket against the readings charted on the schematic. The voltages given were taken with a "Vacuum Tube Voltmeter" with 11 megohms input resistance. Lower resistance meters may give lower readings, particularly in any position where they might load down the circuit. Normal deviation due to line voltage and component variations could reach $\pm 20\%$.

If, by intelligent investigation in the manner outlined above, your problems still are not answered, write to the Heath Company, Engineering Consultation Department. State the name and model (Sine-Square Generator AG-10) of the instrument, and give all symptoms, voltages and other information that may help to analyze your difficulty.

APPLICATIONS

To list all of the uses of your "Heathkit Sine-Square Generator" would require a good many pages of print, so instead we shall cite only a few of the more common applications. Some of these are: Radio and TV repair work, checking oscilloscope performance, as a variable trigger source for telemetering and pulse work, and checking audio and video amplifier response.

SIMULTANEOUS USE OF BOTH WAVEFORMS: Both the sine and square waves can be used at the same time with no detrimental effects to either waveform. This fact makes the use of a recurrent sweep oscilloscope especially easy with this instrument. As an example, in making stage-gain measurements, connect the sine wave output of the AG-10 to the input of the stage to be measured, and connect the square wave output to the external sync connector of the oscilloscope. By using this method of sync. measurements can be made all through a number of amplifier stages without having to readjust the oscilloscope synchronizing controls.

IMPEDANCES: The output voltages stated for this instrument are given for its operation into a high impedance load. As the electronic textbooks tell us, when an instrument is operated into a load that exactly matches its own impedance the output voltage will be exactly half of the amplitude it would be into a very high impedance. Thus, if we have a 1-volt sine wave from the 1-volt range (a 600 Ω source) and connect it to a 600 Ω load, the amplitude will decrease to one-half of a volt. The same would be true, of course, in matching the square wave output to a load of its impedance.

CHECKING THE SQUARE WAVE: Only the very expensive, laboratory type, oscilloscopes have sufficient vertical amplifier response to reproduce very low or very high frequency square waves without distortion. In an average, lower priced, oscilloscope, the low frequencies will tilt the top and bottom of the square wave so that they appear to be pointing downhill from the top, and uphill from the bottom, of the wave form. At the higher frequencies, the leading edge of the waveform will start to become rounded. See Figure 11, Page 32.

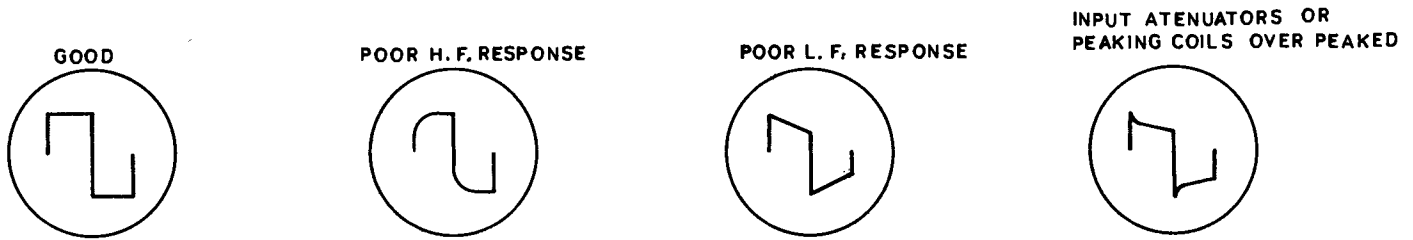

Figure 11

A safe range to check the waveform would probably be from about 500 cycles to 20,000 cycles. If it appears correct in this range, you may be reasonably sure that any faults of the waveform at lower or higher frequencies is due to a lack of response in the vertical amplifier of your oscilloscope, though, even here, if any of the oscilloscope's internal adjustments are not properly made, the corners of the square wave may be rounded or overpeaked, and the top or bottom may be tilted. The surest way of checking the waveform, if it doesn't look correct, would be to connect it directly to the vertical plates of the oscilloscope's cathode ray tube. Using this system, a 10-volt square wave will give a rather small sized presentation on the cathode ray tube, but it will give a true picture of the square wave at all frequencies.

Direct connection can be made to the vertical plates of an oscilloscope's cathode-ray tube, in the following manner.

If your "scope" has provisions for external connections to the cathode ray tube plates, follow the instructions given in its instruction manual for this type of operation. Generally, these connections are found inside a small access door in the rear of the cabinet, and making use of them consists in removing or changing connections on some "screw type" terminals.

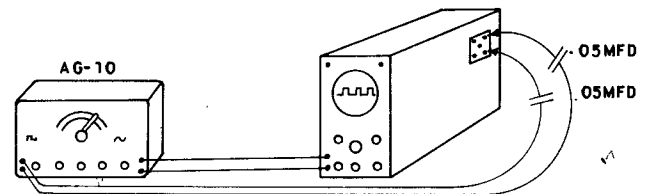

Figure 12

When these connections are changed, connect the sine wave output of the generator to the regular vertical input terminals, or external sync terminals, of the oscilloscope (So the wave form can be synchronized). Connect a .05 μ fd, or larger, capacitor in series with each vertical plate connection (this may not be necessary if there are capacitors connected internally to the "screw type" terminals, although if they are not in the order of .05 μ fd or larger, the low frequencies may be distorted). Connect a lead from one .05 μ fd capacitor to the generators "square-wave-output" post. Connect a lead from the other .05 μ fd capacitor to the generators "ground" post. Turn the square-wave output controls to their maximum positions to get the largest presentation possible on the oscilloscope (the "scopes" vertical amplitude controls are disconnected).

CAUTION: The voltages connected to a cathode-ray tube are often very high, such that they could even be fatal. DO NOT attempt to make connections to the terminals without first disconnecting the line cord from the socket and shorting the various pins to ground with a screw-driver.

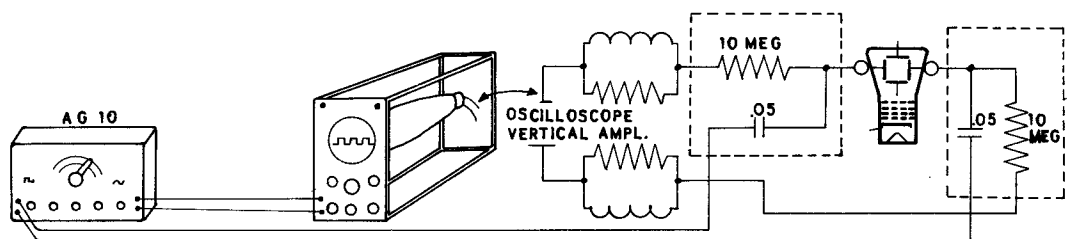

Figure 13

If your oscilloscope has no external provisions for direct connection to the plates, proceed in the following manner: Using the schematic of your "scope" or a tube manual, find the pin numbers of the vertical deflection plates of your cathode ray tube. These will be the ones connected to the plate or plates of the last vertical amplifier stage of the oscilloscope. See Figure 13.

- () Remove all wires from each of the two pins.
- () Temporarily connect a 10 megohm 1/2 watt resistor, and a .05 μ fd (or larger) capacitor to each pin.
- () Connect the other end of one 10 megohm resistor to the wires previously disconnected from that pin.
- () Connect the other end of the remaining 10 megohm resistor to the wires disconnected from its pin.
- () Connect the other ends of the .05 μ fd capacitors to the square wave output posts of the "Generator".
- () So that the waveform will be synchronized, connect leads from the sine wave output posts of the "Generator" to the vertical input or external sync input of the oscilloscope.
- () Turn the square wave output controls to maximum.

When the checks have been completed, remove the resistors and capacitors, and rewire the original connections to each pin.

USING THE RIGHT LEAD: Contrary to any impressions you may have had previously, the square wave is a very tender beast, whose feelings (and shape) are very easily hurt. The coaxial connecting cable, supplied with the kit, has an impedance of 52Ω and will cause a mismatch if used on the 10 volt range, which has a variable, higher impedance. This effect may not be noticed at lower frequencies, but from 200 kc to one megacycle, the rise time of the square wave suffers rather badly. To get the best quality from the 10 volt square wave position it would be well to use regular test leads instead of the coaxial cable, especially in the "X10K" band.

On the 1 volt and .1 volt square wave positions, it is almost a necessity to use the coaxial connecting cable due to the low level. Without it, stray pickup could severely wrinkle the top and bottom of the waveform. If desired, the cable can easily be terminated in its characteristic impedance on these two ranges by connecting a resistor between the binding posts at the end of the "Coax". Much better results may also be obtained by using this cable on the lower "sine wave" ranges.

DC VOLTS AND SQUARE WAVE AMPLITUDE: As the schematic will show, the square wave output is direct coupled to the cathode of the cathode-follower. Since the cathode follower is cut-off for one-half of each cycle, the negative portion of the square wave is essentially clamped to ground. Should your particular application require a complete absence of DC Voltage, merely insert a capacitor in series with the red output lead. Remember when doing this, that this capacitor will have to be very large to pass a low frequency square wave with no distortion. Even a 100 μ fd, 15 v. capacitor (connect the + end to the generator) will tilt the 20-cycle waveform slightly.

As stated in the specifications, the 10 volt square wave may vary as much as $\pm 5\%$ in amplitude. The primary reason for this is due to changes in the input line voltage. For example, if the input line decreases, the voltage of each 50 μ fd capacitor decreases also, making B+ voltage low. This effect is not so noticeable in the sine wave section due to the stabilizing influence of the 3-watt lamp.

CONNECTING NETWORKS: For those cases when you may wish to couple a square wave into an instrument of a low impedance other than 52Ω, a simple "pad" can be constructed. (This only applies to the two 52Ω impedance switch positions, of course.) This will mean a large loss in signal from the value at the generator output, but there will be no waveform distortion introduced by impedance mismatching. It should be constructed from small composition (not wirewound) resistors. Three of the most commonly needed "pads" are shown.

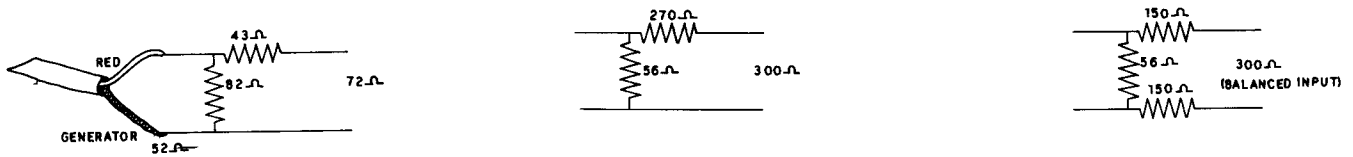

Figure 14

This matching while not theoretically perfect, is generally adequate.

Fast rise time trigger pulses can be easily formed at the square wave output by the addition of a single resistor and capacitor, forming a differentiating network.

The size of the resistors and capacitors depend on the frequency you desire to operate at and how wide a pulse you wish to have. The "rule of thumb" for pulse width would state that it should be about 1/10 as wide as the positive (or negative) half of the square wave, at the frequency desired. The sizes of the resistor and capacitor are generally found by experimenting, but a close approximation can be found in the following manner.

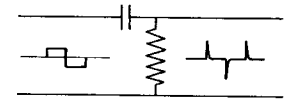

Figure 15

$$\frac{1}{\text{freq. of sq. wave}} \times \frac{1}{2} = \text{time of 1/2 cycle of square wave.} \times \frac{1}{10} = \text{Pulse width for average pulse in fractions of a second.}$$

Collecting the above together we get:

$$\frac{1}{\text{freq. of sq. wave}} \times \frac{1}{20} = \text{time of pulse width for average pulse.}$$

To find the size of pulse that a resistor and capacitor will give, multiply the resistance in ohms by the capacitance in "farads" (1 μf = .000001 farads). The answer will be the "Time Constant" of the two parts, and will be a portion of time, usually expressed in "micro-seconds", which is one-millionths of a second. If the "Time Constant" of the resistor and capacitor you choose isn't the same as the pulse width you desire, change the value of either or both parts until the "Time Constant" and "pulse width" are equal.

For example, if you desire positive pulses at a frequency of 10 kc:

$$\frac{1}{10,000} \times \frac{1}{20} = 5 \text{ micro-seconds (millionths of a second)}$$

Selecting a 10K resistor and a .0005 μfd capacitor

$$\frac{500 \times 10^{-12}}{.01 \times 10^6}$$

$$5 \times 10^{-6} \text{ or } 5 \text{ micro-seconds}$$

or, figured another way:

$$\frac{.0000000005 \text{ farads}}{10000}$$

$$.0000050000 \text{ seconds or } 5 \text{ micro-seconds}$$

ACCURACY

The accuracy of calibration of any instrument is only as accurate as the instruments used, and the amount of care taken, to calibrate it. This is just as true of commercially produced instruments as it is of kits. For an example, if you set your AG-10 sine-wave output to 10 volts with the "feedback" control, using a meter that is incorrect by 5%, the AG-10 output will also be incorrect by 5%. The same thing would be true with frequency response, or any other measurement or calibration where another instrument is involved.

Note that the sine wave and square wave amplitude controls are each divided up into ten divisions. It is impractical to closely control the rotational accuracy of these controls, since the high cost of the accuracy would unduly increase the cost of the kit. Since this is true, these markings are in the positions indicated by averaging the linearity characteristics of a large number of those controls. By our tests, accuracy of $\pm 20\%$ could usually be expected on these markings.

If greater accuracy than this is required, the output voltage should be continuously monitored by a meter of known accuracy in the frequency range required. A peak reading, or peak to peak reading meter is necessary when using square waves. Information concerning the accuracy of a meter, can usually be found in literature concerning it.

REPLACEMENTS

Material supplied with Heathkits has been carefully selected to meet design requirements and ordinarily will fulfill its function without difficulty. Occasionally improper instrument operation can be traced to a faulty tube or component. Should inspection reveal the necessity for replacement, write to the Heath Company and supply all of the following information:

- A. Thoroughly identify the part in question by using the part number and description found in the manual parts list.
- B. Identify the type and model number of kit in which it is used.
- C. Mention the order number and date of purchase.
- D. Describe the nature of defect or reason for requesting replacement.

The Heath Company will promptly supply the necessary replacement. Please do not return the original component until specifically requested to do so. Do not dismantle the component in question as this will void the guarantee. If tubes are to be returned, pack them carefully to prevent breakage in shipment as broken tubes are not eligible for replacement. This replacement policy does not cover the free replacement of parts that may have been broken or damaged through carelessness on the part of the kit builder.

SERVICE

In the event continued operation difficulties of the completed instrument are experienced, the facilities of the Heath Company Service Department are at your disposal. Your instrument may be returned for inspection and repair for a service charge of \$6.00 plus the cost of any additional material that may be required. **THIS SERVICE POLICY APPLIES ONLY TO COMPLETED INSTRUMENTS CONSTRUCTED IN ACCORDANCE WITH THE INSTRUCTIONS AS STATED IN THE MANUAL.** Instruments that are not entirely completed or instruments that are modified in design will not be accepted for repair. Instruments showing evidence of acid core solder or paste fluxes will be returned not repaired.

The Heath Company is willing to offer its full cooperation to assist you in obtaining the specified performance level in your instrument. Factory repair service is available to you or you may contact the Technical Consultation Department by mail. For information regarding possible modification of existing kits, it is suggested that you refer to any one or more of the many publications that are available on all phases of electronics. They can be obtained at or through your local library, as well as at any electronic outlet store.

Although the Heath Company sincerely welcomes all comments and suggestions, it would be impossible to design, test, evaluate and assume responsibility for proposed circuit changes for specific purposes. Therefore, such modifications must be made at the discretion of the kit builder according to information which will be much more readily available from some local source.

SHIPPING INSTRUCTIONS

Before returning a unit for service, be sure that all parts are securely mounted.

ATTACH A TAG TO THE INSTRUMENT GIVING
NAME, ADDRESS AND TROUBLE EXPERIENCED.

Pack in a rugged container, preferably wood, using at least three inches of shredded newspaper or excelsior on all sides. DO NOT SHIP IN THE ORIGINAL KIT CARTON AS THIS CARTON IS NOT CONSIDERED ADEQUATE FOR SAFE SHIPMENT OF THE COMPLETED INSTRUMENT. Ship by prepaid express if possible. Return shipment will be made by express collect. Note that a carrier cannot be held liable for damage in transit if packing, in HIS OPINION, is insufficient.

SPECIFICATIONS

All prices are subject to change without notice. The Heath Company reserves the right to discontinue instruments and to change specifications at any time without incurring any obligation to incorporate new features in instruments previously sold.

PARTS LIST

<u>PART No</u>	<u>PARTS Per Kit</u>	<u>DESCRIPTION</u>	<u>PART No.</u>	<u>PARTS Per Kit</u>	<u>DESCRIPTION</u>
Resistors			Resistors (continued)		
1-2	1	68Ω 1/2 watt, blue-gray-black	2-122	1	8 meg 1/2 watt 1%
1-9	2	1 KΩ 1/2 watt, brown-black-red	2-123	1	800K 1/2 watt 1%
1-14	1	3.3K 1/2 watt, orange-orange-red	2-124	1	80K 1/2 watt 1%
1-16	1	4.7K 1/2 watt, yellow-violet-red	2-125	1	8K 1/2 watt 1%
1-20	1	10K 1/2 watt, brown-black-orange	2-126	1	710Ω 1/2 watt 1%
1-25	1	47K 1/2 watt, yellow-violet-orange	3-1E	1	2500Ω 7 watt
1-26	4	100K 1/2 watt, brown-black-yellow	3-9E	1	3000Ω 5 watt
1-29	2	220K 1/2 watt, red-red-yellow	3-4G	2	5000Ω 7 watt
1-33	1	470K 1/2 watt, yellow-violet-yellow	3-5G	1	250Ω 7 watt
1-35	3	1 megohm 1/2 watt, brown-black-green	Capacitors		
1-52	1	680Ω 1/2 watt 5%, blue-gray-brown	21-3	3	10 μmf disc
1-58	1	22K 1/2 watt 5%, red-red-orange	21-14	1	.001 μf disc
1-62	1	51Ω 1/2 watt, green-brown-black	21-60	1	18 μmf 5%
1-63	2	510Ω 1/2 watt, green-brown-brown	23-17	2	2 μfd 200 v.
1-83	1	56Ω 1/2 watt 5%, green-blue-black	23-20	1	1 μfd 200 v.
1-84	1	62Ω 1/2 watt 5%, blue-red-black	23-28	2	.1 μfd 200 v.
1-96	2	750Ω 1/2 watt 5%, violet-green-brown	23-71	1	4 μfd 200 v. ± 20%
1-103	1	33Ω 1/2 watt, orange-orange-black	25-20	2	40 μfd electrolytic 150 v.
1-113	1	5.6 KΩ 1/2 watt 5%, green-blue-red	25-48	1	4 x 40 μfd 350-300-250-250 v.
1-114	1	8.2K 1/2 watt 5%, gray-red-red	25-41	1	40 μfd 350 v.
1-116	3	6.2K 1/2 watt 5%, blue-red-red	25-58	1	50-50, μfd, series connected 200 v. ea.
1-3A	1	3.3K 1 watt, orange-orange-red	25-59	1	100 μfd 350 v. + 40 μfd 300 v.
1-9A	1	10K 1 watt, brown-black-orange	26-39	1	3.2 - 11 μμ dual trimmer
1-23A	1	2.2K 1 watt, red-red-red	26-40	1	tuning capacitor
2-38A	1	36 megohm 1 watt 1%	31-5	1	7-35 μmf trimmer
2-118	1	3.6 megohm 1/2 watt 1%	31-6	1	5-20 μmf trimmer
2-119	1	360 KΩ 1/2 watt 1%			
2-120	1	36K 1/2 watt 1%			
2-121	1	3600Ω 1/2 watt 1%			

PARTS LIST
(continued)

<u>PART No.</u>	<u>PARTS Per Kit</u>	<u>DESCRIPTION</u>	<u>PART No.</u>	<u>PARTS Per Kit</u>	<u>DESCRIPTION</u>
Tubes-Lamps-Rectifiers			Transformers-Chokes-Coils		
411-24	1	12AT7 tube	54-59	1	Power transformer
411-63	2	6CL6 tube	40-102	1	220-523 mh coil
411-67	1	6CB6 tube	45-2	1	RF choke
411-96	1	6AW8 tube	45-27	1	RF choke
412-1	1	#47 pilot lamp	Sockets-Terminal Strips		
412-2	1	3 watt 120 v lamp	422-2	1	Dual silicon rectifier holder
57-21	2	Silicon rectifiers	434-16	2	9-pin wafer socket
Controls and Switches			434-23	1	3-watt lamp socket
10-8	1	10K pot.	434-35	1	7-pin ceramic socket
10-25	1	100K pot.	434-44	1	Pilot lamp socket
10-27	1	3K pot.	434-56	2	9-pin socket
10-61	1	200Ω pot linear, tab mtg.	431-1	5	1-lug terminal strip
19-34	1	400Ω linear control, SPST switch	431-2	4	2-lug terminal strip
63-47	1	3 position, single deck, switch	431-3	1	3-lug terminal strip
63-137	1	5 position, ceramic, 2 deck switch	431-15	1	1-lug terminal strip
63-138	1	4 position, single deck switch	431-32	1	2-lug terminal strip for #8 screws
Metal Parts			431-33	1	3-lug terminal strip for #8 screws
90-24	1	Cabinet	Binding Post-Connector Parts		
200-M132	1	Chassis	100-M16B	3	Binding post cap, black
203-128F169	1	Front panel, painted and screened	100-M16R	3	Binding post cap, red
204-M139	1	Trimmer mounting bracket	427-2	6	Binding post base
206-M36	1	Lower front shield	75-15	2	Terminal half-shell, drilled
206-M37	2	Rear shield	75-16	2	Terminal half-shell, plain
206-M39	1	Bottom shield	75-17	8	Insulator bushing
206-M52	1	Upper front shield	260-16	2	Alligator clips
206-M53	1	Top shield	262-3	2	Banana pin
Hardware			Miscellaneous		
250-2	10	3-48 x 5/16" screws RHMS	73-1	1	3/8" rubber grommet
250-7	3	6-32 x 3/16" screws RHMS	73-4	2	3/16" rubber grommet
250-8	10	#6 sheet metal screws	75-5	1	Capacitor mounting insulator
250-9	16	6-32 x 3/8" screws RHMS	89-1	1	Line cord
250-13	1	6-32 x 1" screw	100-M10	1	Pointer assembly
250-15	2	#8 set screw	208-2	1	Capacitor clip
250-18	4	8-32 x 3/8" screws RHMS	211-4	1	Handle
250-83	2	#10 x 3/8" handle screws	261-1	4	Rubber feet
250-32	2	6-32 x 3/8" screws flat head	340-2	1	length bare wire
250-34	2	4-40 x 1/2" screws RHMS	341-1	1	length black test lead
250-87	2	8-32 x 3/16" screws RHMS	341-2	1	length red test lead
252-1	10	3-48 nuts	343-2	1	length coax cable
252-2	2	4-40 nuts	344-1	1	length hookup wire
252-3	27	6-32 nuts	346-1	1	length sleeving
252-4	4	8-32 nuts	346-6	1	length fiberglass tubing
252-7	7	Control nut	413-3	1	Fastex plastic plug
253-10	7	Nickel control washer	462-19	5	Knob with skirt
253-34	1	Fiber washer, red	462-44	1	Large knob
253-35	1	Fiber washer, black	481-3	3	Capacitor mounting wafer
254-1	17	#6 lockwashers	453-5	1	Insulated extension
254-2	6	#8 lockwashers	595-182	1	Manual
254-5	6	Control lockwashers			
254-7	10	#3 lockwashers			
255-5	1	#6 x 3/4" spacer			
259-1	10	Solder lugs			
259-10	1	Control solder lugs			

WARRANTY

Heath Company warrants that for a period of three months from the date of shipment, all Heathkit parts shall be free of defects in materials and workmanship under normal use and service and that in fulfillment of any breach of such warranty, Heath Company shall replace such defective parts upon the return of the same to its factory. The foregoing warranty shall apply only to the original buyer, and is and shall be in lieu of all other warranties, whether express or implied and of all other obligations or liabilities on the part of Heath Company and in no event shall Heath Company be liable for any anticipated profits, consequential damages, loss of time or other losses incurred by the buyer in connection with the purchase, assembly or operation of Heathkits or components thereof. No replacement shall be made of parts damaged by the buyer in the course of handling or assembling Heathkit equipment.

NOTE: The foregoing warranty is completely void and we will not replace, repair or service instruments or parts thereof in which acid core solder or paste fluxes have been used.

HEATH COMPANY

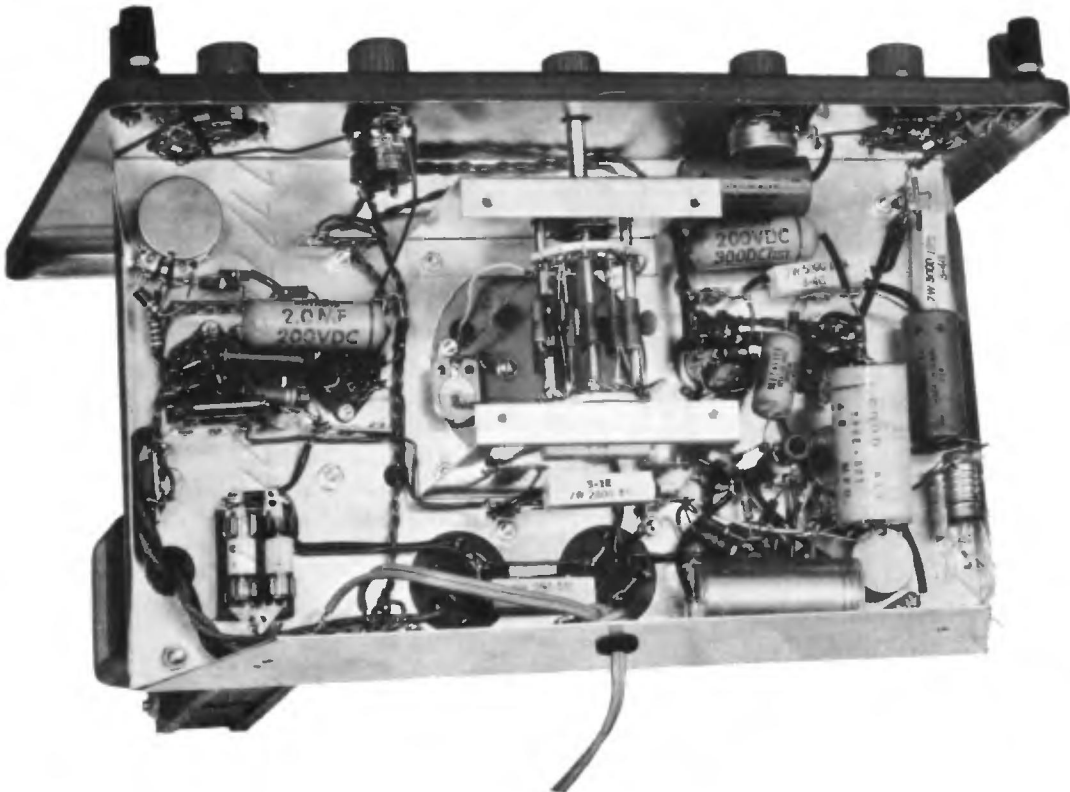

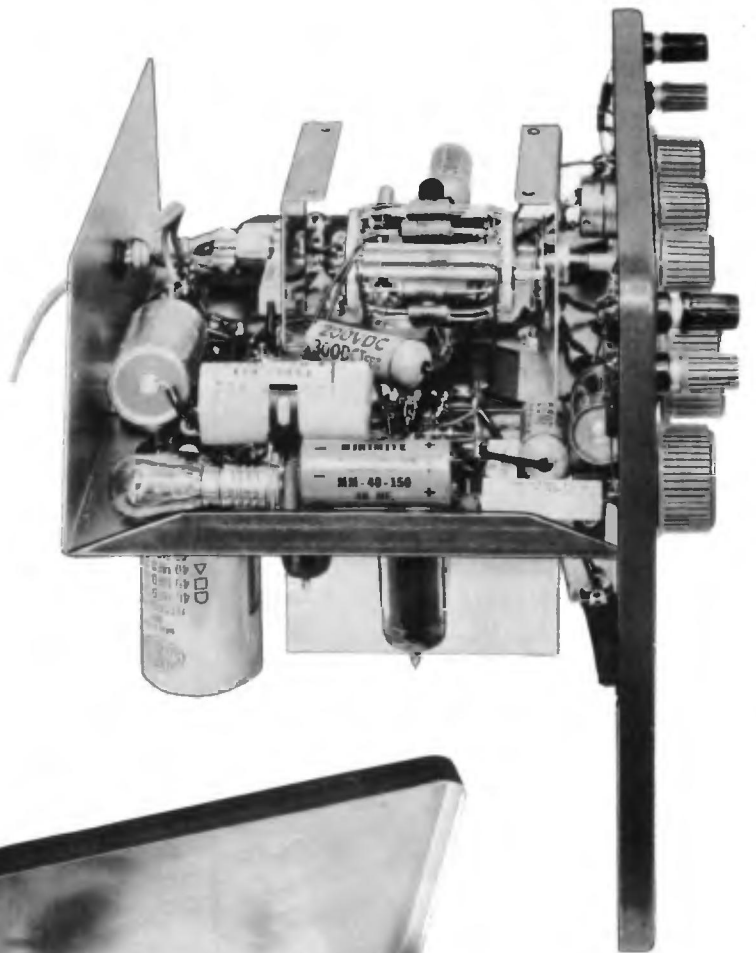



STANDARD COLOR CODE — RESISTORS AND CAPACITORS

<p>AXIAL LEAD RESISTOR</p> <p>Brown — Insulated Black — Non-insulated</p> <p>Wire wound resistors have 1st digit band double width</p>	<table border="1"> <thead> <tr> <th>INSULATED UNINSULATED Color</th> <th>FIRST RING BODY COLOR First Figure</th> <th>SECOND RING END COLOR Second Figure</th> <th>THIRD RING DOT COLOR Multiplier</th> </tr> </thead> <tbody> <tr><td>BLACK</td><td>0</td><td>0</td><td>None</td></tr> <tr><td>BROWN</td><td>1</td><td>1</td><td>0</td></tr> <tr><td>RED</td><td>2</td><td>2</td><td>00</td></tr> <tr><td>ORANGE</td><td>3</td><td>3</td><td>,000</td></tr> <tr><td>YELLOW</td><td>4</td><td>4</td><td>0,000</td></tr> <tr><td>GREEN</td><td>5</td><td>5</td><td>00,000</td></tr> <tr><td>BLUE</td><td>6</td><td>6</td><td>000,000</td></tr> <tr><td>VIOLET</td><td>7</td><td>7</td><td>0,000,000</td></tr> <tr><td>GRAY</td><td>8</td><td>8</td><td>00,000,000</td></tr> <tr><td>WHITE</td><td>9</td><td>9</td><td>000,000,000</td></tr> </tbody> </table>	INSULATED UNINSULATED Color	FIRST RING BODY COLOR First Figure	SECOND RING END COLOR Second Figure	THIRD RING DOT COLOR Multiplier	BLACK	0	0	None	BROWN	1	1	0	RED	2	2	00	ORANGE	3	3	,000	YELLOW	4	4	0,000	GREEN	5	5	00,000	BLUE	6	6	000,000	VIOLET	7	7	0,000,000	GRAY	8	8	00,000,000	WHITE	9	9	000,000,000	<p>DISC CERAMIC RMA CODE</p>
INSULATED UNINSULATED Color	FIRST RING BODY COLOR First Figure	SECOND RING END COLOR Second Figure	THIRD RING DOT COLOR Multiplier																																											
BLACK	0	0	None																																											
BROWN	1	1	0																																											
RED	2	2	00																																											
ORANGE	3	3	,000																																											
YELLOW	4	4	0,000																																											
GREEN	5	5	00,000																																											
BLUE	6	6	000,000																																											
VIOLET	7	7	0,000,000																																											
GRAY	8	8	00,000,000																																											
WHITE	9	9	000,000,000																																											
<p>RADIAL LEAD DOT RESISTOR</p>	<p>5-DOT RADIAL LEAD CERAMIC CAPACITOR</p>	<p>EXTENDED RANGE TC CERAMIC HICAP</p>																																												
<p>RADIAL LEAD (BAND) RESISTOR</p>	<p>BY-PASS COUPLING CERAMIC CAPACITOR</p>	<p>AXIAL LEAD CERAMIC CAPACITOR</p>																																												

The standard color code provides all necessary information required to properly identify color coded resistors and capacitors. Refer to the color code for numerical values and the zeroes or multipliers assigned to the colors used. A fourth color band on resistors determines tolerance rating as follows: Gold = 5%, silver = 10%. Absence of the fourth band indicates a 20% tolerance rating.

The physical size of carbon resistors is determined by their wattage rating. Carbon resistors most commonly used in Heathkits are 1/2 watt. Higher wattage rated resistors when specified are progressively larger in physical size. Small wire wound resistors 1/2 watt, 1 or 2 watt may be color coded but the first band will be double width.

MOLDED MICA TYPE CAPACITORS

<p>CURRENT STANDARD CODE</p> <p>JAN & 1948 RMA CODE</p>	<p>RMA 3-DOT (OBSOLETE) RATED 500 W.V.D.C. ± 20% TOL.</p>	<p>BUTTON SILVER MICA CAPACITOR</p>
<p>RMA (5-DOT OBSOLETE CODE)</p>	<p>RMA 6-DOT (OBSOLETE)</p>	<p>RMA 4-DOT (OBSOLETE)</p>

MOLDED PAPER TYPE CAPACITORS

<p>TUBULAR CAPACITOR</p> <p>Normally stumped for value</p> <p>A 2 digit voltage rating indicates more than 900 V. Add 2 zeros to end of 2 digit number.</p>	<p>MOLDED FLAT CAPACITOR Commercial Code</p>	<p>JAN. CODE CAPACITOR</p>
--	---	-----------------------------------

The tolerance rating of capacitors is determined by the color code. For example: red = 2%, green = 5%, etc. The voltage rating of capacitors is obtained by multiplying the color value by 100. For example: orange = 3 × 100 or 300 volts. Blue = 6 × 100 or 600 volts.

In the design of Heathkits, the temperature coefficient of ceramic or mica capacitors is not generally a critical factor and therefore Heathkit manuals avoid reference to temperature coefficient specifications.

HEATH COMPANY

A Subsidiary of Daystrom Inc.

THE WORLD'S FINEST ELECTRONIC EQUIPMENT IN KIT FORM

BENTON HARBOR, MICHIGAN