

Heathkit[®] Manual for the

LINEAR AMPLIFIER

Model SB-1000

595-3795-01

Please perform the following steps and assemble your 3-ring binder before you assemble your kit. Do not unpack your kit until you are instructed to do so.

- () Refer to Figure 1, locate the envelope marked "Binder Hdw", and remove the hardware.
- () Position the binder cover with the large hole as shown.
- () Determine which side of the rings unhook. Then position the ring assembly as shown and mount it to the cover with the binder hardware: two 6-32 x 3/8" nylon screws, two flat washers, and two 6-32 nuts as shown. Do not overtighten the hardware.
- () If it has not already been done, carefully remove the Manual and its Illustration Booklet, Schematic, etc. from its wrapping.
- () Unfasten the rings (if they are fastened) and place the Manual in the binder. Set the Illustration Booklet and any other Manual portions aside.
- () Refasten the rings.
- () Discard this page and proceed with your Manual. NOTE: Install the Illustration Booklet and any other Manual portions in the back of the binder after you assemble your kit.

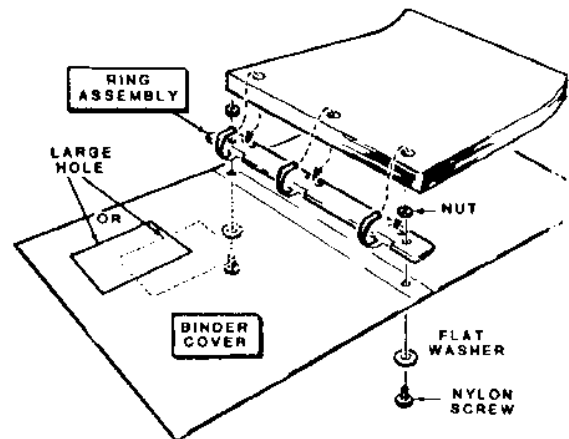

Figure 1

HEATH COMPANY
BENTON HARBOR, MICHIGAN 49022

Copyright © 1987
Heath Company
All Rights Reserved
Printed in the United States of America

LINEAR AMPLIFIER

Model SB-1000

595-3795-01

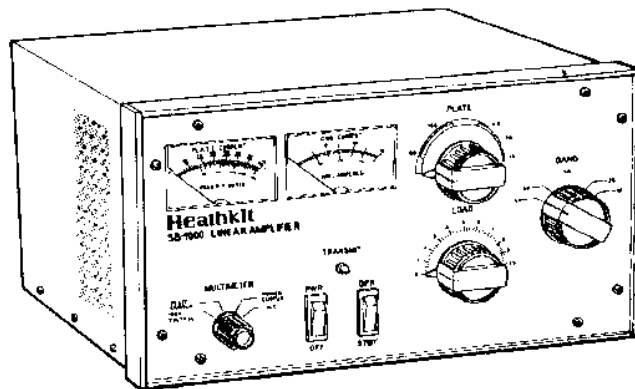

WARNING: Do not expose this Amplifier to rain or moisture. Never operate the unit if liquid has accidentally spilled into it. If this should happen, have the unit checked by a qualified service technician before you use it again. Otherwise, fire or electrical shock could result.

HEATH COMPANY
BENTON HARBOR, MICHIGAN 49022

Copyright © 1987
Heath Company
All Rights Reserved
Printed in the United States of America

"Federal Communications Commission requirements prescribe type acceptance of linear power amplifiers operating below 144 MHz in Part 97 of the Rules and Regulations. This Linear Amplifier will meet these requirements when constructed in strict accordance with the instructions in this manual, using only components and materials supplied with the kit or the exact equivalent thereof. You will be instructed to sign, date, place your amateur call sign, class of license, expiration date of license on the included label and affix the label to the Linear Amplifier certifying that you have constructed this Linear Amplifier in accordance with the above mentioned instructions. In order to meet legal requirements, be certain to follow the instructions exactly as they are stated in this Manual."

CAUTION

Use extreme care during initial testing and all subsequent operation of this Linear Amplifier. While the Amplifier is designed for maximum safety, never lose respect for the high voltage present in this unit. Protect yourself always against lethal or severe electric shock.

HEATH COMPANY

Table of Contents

<p>INTRODUCTION 4</p> <p>SPECIFICATIONS 5</p> <p>UNPACKING INSTRUCTIONS 7</p> <p>ASSEMBLY NOTES 8</p> <p>RECTIFIER CIRCUIT BOARD</p> <p>Parts List 11</p> <p>Step-by-Step Assembly 13</p> <p>FILTER CIRCUIT BOARD</p> <p>Parts List 17</p> <p>Step-by-Step Assembly 18</p> <p>ALC/POWER CIRCUIT BOARD</p> <p>Parts List 20</p> <p>Step-by-Step Assembly 21</p> <p>METER CIRCUIT BOARD</p> <p>Parts List 23</p> <p>Step-by-Step Assembly 24</p> <p>INPUT FILTER</p> <p>Parts List 27</p> <p>Step-by-Step Assembly 29</p>	<p>CHASSIS</p> <p>Parts List 33</p> <p>Step-By-Step Assembly 36</p> <p>INITIAL TESTS AND ALIGNMENT 53</p> <p>Initial Tests 53</p> <p>Alignment 54</p> <p>FINAL ASSEMBLY 57</p> <p>INSTALLATION 58</p> <p>OPERATION 61</p> <p>Reading the Meters 61</p> <p>General Information 62</p> <p>Tune-up 63</p> <p>Periodic Maintenance 64</p> <p>IN CASE OF DIFFICULTY 65</p> <p>Troubleshooting Chart 66</p> <p>CIRCUIT DESCRIPTION 68</p> <p>CIRCUIT BOARD X-RAY VIEWS (Illustration Booklet, Page 67)</p> <p>SEMICONDUCTOR IDENTIFICATION 72</p> <p>SCHEMATIC (Illustration Booklet, Page 70)</p> <p>WARRANTY Inside front cover</p> <p>CUSTOMER SERVICE Inside rear cover</p>
---	---

INTRODUCTION

The Heathkit Model SB-1000 Linear Amplifier is a completely self-contained, grounded grid, linear amplifier. It is designed to operate at 1000 watts PEP output on SSB or 850 watts output on CW.

The Amplifier is designed to be used with exciters which deliver 100 watts or more output. It can be used with less driving power, but will have a lower output.

A broad-band, tuned-input circuit for each band feeds the 3-500Z triode tube that is connected in a grounded-grid configuration.

An ALC circuit develops negative voltage that can be fed back to the exciter to reduce its gain when the Amplifier is overdriven.

The antenna change-over relay is normally actuated by relay contacts, or an electronic switch, in the exciter to place the Amplifier in the transmit mode. NOTE: The contacts or switch must be connected to ground. Operational problems may occur if the contacts have more than zero volts DC.

The Amplifier may be operated from either 120 VAC or 240 VAC, 50/60 Hz power sources. Operation from a 240-volt AC line is recommended. Each side of the line cord is equipped with a fuse to protect against overloads.

SPECIFICATIONS

Band Coverage	160, 80, 40, 20 and 15 meter amateur bands (also operable on MARS and WARC bands, where applicable).
Driving Power Required	100 watts, maximum (85 watts, typical).
Maximum Power Output	SSB: 1000 watts P.E.P. CW: 850 watts.
Duty Cycle	SSB: Continuous voice modulation. CW: 50%. 30 minutes of continuous carrier at 500 watts.
ALC	0—20 volts, adjustable, negative-going.
Third Order Distortion	-30 dB or better.
Keying	Requires contact closure or sink of +12 volts DC @ 100 mA.
Input Impedance	50 Ω unbalanced.
Output Impedance	50 Ω unbalanced; SWR 2:1 or less.
Front Panel	Multimeter (high voltage, plate current, power output, and ALC). Grid current meter. Multimeter function switch. Transmit indicator. PWR/OFF switch. OPR/STBY switch. Plate. Load. Band switch.

Rear Panel	RF Output (SO-239). RF Input (SO-239). RELAY (phono). ALC Out (phono). ALC ADJ control. +12 VDC (phono). Ground post. Line cord. Fuses (two 15-ampere for 120 VAC or two 10-ampere for 240 VAC).
Tube	One 3-500Z.
Power Required	120 VAC, 50/60 Hz, at 15-amperes maximum. 240 VAC, 50/60 Hz, at 7-1/2-amperes maximum.
Dimensions (overall)	8-1/4" H x 14-1/2" W x 15-1/2" D. (21 x 36.8 x 35.2 cm).
Net Weight	48 lbs. (21.8 kg).

The Heath Company reserves the right to discontinue products and to change specifications at any time without incurring any obligation to incorporate new features in products previously sold.

UNPACKING INSTRUCTIONS

Do not unpack any part of your kit until a step directs you to do so.

Locate the "Pack Index Sheet" that is packed inside the main shipping carton for your Linear Amplifier. Note that the shipping carton is divided into six smaller sections. These sections make up Packs 1 through 5-- and the Final Pack, which may be made up of several bags, envelopes, small boxes, and loose parts. Do not unpack any of these parts until a step specifically directs you to do so.

When you check parts against a "Parts List," return any part or group of parts packaged in a bag or other container, with a part number on it, to its container after you identify it. Leave these parts there until you actually use them in a step. This will help prevent you from mixing up the parts, and help you identify the parts when you need them.

Some parts, however, are in a bag or envelope that is not marked with an actual part number, but with a packaging number that begins with the number "173-." These numbers are used for packaging purposes only and do not appear in the Manual parts lists. Open each bag or envelope that is marked with only a "173-" packaging number to identify the parts it contains.

NOTE: Never use a "173-" packaging number if you must order a replacement part. Use only the part numbers listed in a Manual parts list for this purpose.

Save all of the packaging material until you account for all of the parts.

ASSEMBLY NOTES

TOOLS

You will need these tools to assemble your kit.

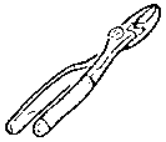

PLIERS

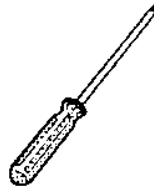
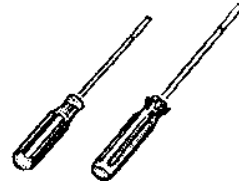
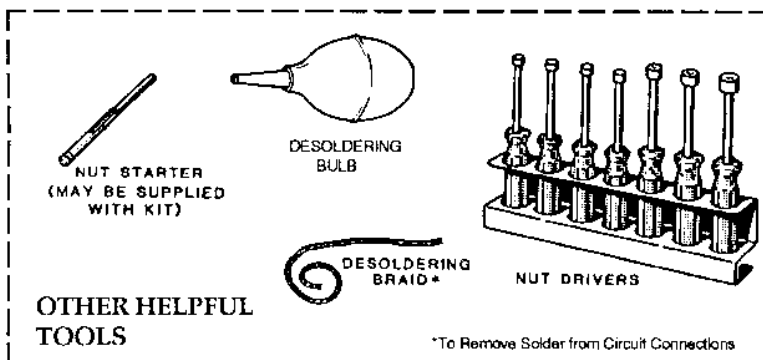
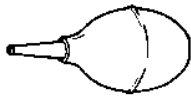
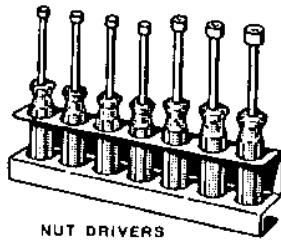
LONG-NOSED
PLIERSDIAGONAL
CUTTERSWIRE
STRIPPERSPHILLIPS
SCREWDRIVER1/8" & 1/4" BLADE
SCREWDRIVERSNUT STARTER
(MAY BE SUPPLIED
WITH KIT)DESOLDERING
BULBDESOLDERING
BRAID*

NUT DRIVERS

OTHER HELPFUL TOOLS

*To Remove Solder from Circuit Connections

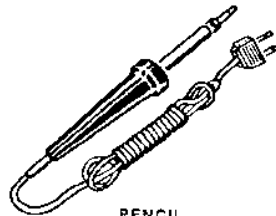
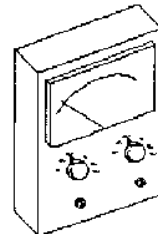
PENCIL
SOLDERING IRON
(22 to 25 WATTS)VOM, VTVM,
OR DMM

ASSEMBLY

1. Follow the instructions carefully. Read the entire step before you perform each operation.
2. The illustrations in the Manual are called Pictorials and Details. Pictorials show the overall operation for a group of assembly steps; Details generally illustrate a single step. When you are directed to refer to a certain Pictorial "for the following steps," continue to use that Pictorial until you are referred to another Pictorial for another group of steps.
3. Most kits use a separate "Illustration Booklet" that contains illustrations (Pictorials, Details, etc.) that are too large for the Assembly Manual. Keep the "Illustration Booklet" with the Assembly Manual. The illustrations in it are arranged in Pictorial number sequence.
4. Position all parts as shown in the Pictorials.
5. Solder instructions are generally given only at the end of a series of similar steps. You may solder more often if you desire.

6. Each circuit part in an electronic kit has its own component number (R2, C2, etc.). Use these numbers when you want to identify the same part in the various sections of the Manual. These numbers, which are especially useful if a part has to be replaced, appear:

- In the Parts List,
- At the beginning of each step where a component is installed,
- In some illustrations,
- In the Schematic,
- In the section at the rear of the Manual.

7. When you are instructed to cut something to a particular length, use the scales (rulers) provided at the bottom of the Manual pages.

SAFETY WARNING: Avoid eye injury when you cut off excessive lead lengths. Hold the leads so they cannot fly toward your eyes.

SOLDERING

Soldering is one of the most important operations you will perform while assembling your kit. A good solder connection will form an electrical connection between two parts, such as a component lead and a circuit board foil. A bad solder connection could prevent an otherwise well-assembled kit from operating properly.

It is easy to make a good solder connection if you follow a few simple rules:

1. Use the proper type of soldering iron. A 22- to 25-watt pencil soldering iron with a 1/8" or 3/16" chisel or pyramid top works best.
2. Keep the soldering iron tip clean. Wipe it often on a wet sponge or cloth; then apply solder to the tip to give the entire tip a wet look. This process is called "tinning," and it will protect the tip and enable you to make good connections. When the solder tends to "ball" or does not stick to the tip, the tip needs to be cleaned and retinned.

NOTE: Always use rosin core, radio-type solder (60:40 tin-lead content) for all of the soldering in this kit. This is the type we have supplied with the parts. The Warranty will be void and we will not service any kit in which acid core solder or paste flux has been used.

RESISTOR VALUE	RESISTOR VALUE	RESISTOR VALUE	RESISTOR VALUE
100K	10K	1K	100
10K	1K	100	10
1K	100	10	1

CAPACITOR VALUE	CAPACITOR VALUE	CAPACITOR VALUE	CAPACITOR VALUE
1000	100	10	1
100	10	1	0.1
10	1	0.1	0.01

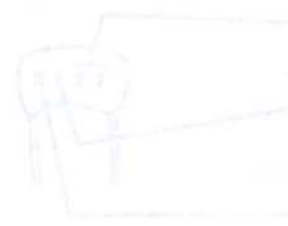

RESISTORS

Resistors are identified in Parts Lists and steps by their resistance value in Ω (ohms), kΩ (kilohms), or MΩ (megohms). They are usually identified by a color code of four or five color bands, where each color represents a number. See the "Resistor Color Code" chart. These colors are given in the steps in their proper order (except the last band, which indicates a resistor's "tolerance"; see the "Resistor Tolerance Chart"). You do not need to memorize the color codes.

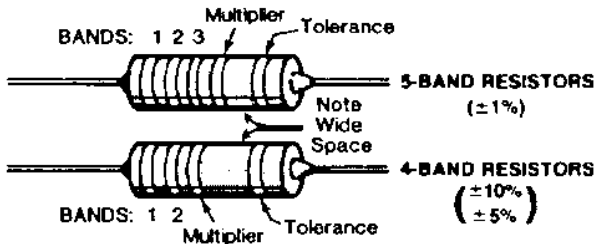

Occasionally, a "precision" or "power" resistor may have the value stamped on it. The letter R, K, or M may also be used at times to signify a decimal point, as in:
 2R2 = 2.2 Ω
 2K2 = 2.2 kΩ, or 2200 Ω
 2M2 = 2.2 MΩ

Precision resistors may also be marked as shown in the following examples. The values of the multipliers are shown in the "Multiplier Chart," and the tolerance values are shown in the "Resistor Tolerance" chart.

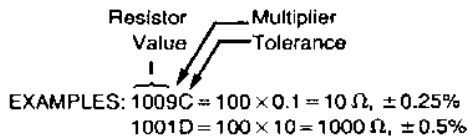

CAPACITORS

Capacitors will be called out by their capacitance value in μF (microfarads) or pF (picofarads) and type: ceramic, Mylar®, electrolytic, etc. Some capacitors may have their value printed in the following manner:

First and second digits of capacitor's value: 15

Multiplier: Multiply the first & second digits by the proper value from the "Multiplier Chart."

To find the tolerance of the capacitor, look up this letter in the capacitor Tolerance chart.

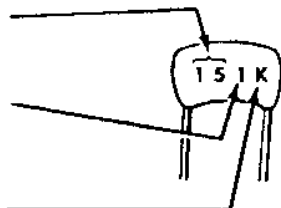

RESISTOR COLOR CODE

	Band 1	Band 2 (if used)	Band 3	Multiplier
Color	1st Digit	2nd Digit	3rd Digit	
Black	0	0	0	1
Brown	1	1	1	10
Red	2	2	2	100
Orange	3	3	3	1,000
Yellow	4	4	4	10,000
Green	5	5	5	100,000
Blue	6	6	6	1,000,000
Violet	7	7	7	10,000,000
Gray	8	8	8	100,000,000
White	9	9	9	—
Silver	—	—	—	.01
Gold	—	—	—	.1

RESISTOR TOLERANCE

	COLOR OR LETTER	
± 10%	SILVER	
± 5%	GOLD	J
± 2%	RED	G
± 1%	BROWN	F
± 0.5%	GREEN	D
± 0.25%	BLUE	C
± 0.1%	VIOLET	B
± 0.05%	GRAY	

MULTIPLIER CHART

FOR THE NUMBER:	MULTIPLY BY:	FOR THE NUMBER:	MULTIPLY BY:
0	1	4	10,000
1	10	5	100,000
2	100	8	0.01
3	1000	9	0.1

CAPACITOR TOLERANCE

LETTER	10 pF OR LESS	OVER 10 pF
B	± 0.1 pF	
C	± 0.25 pF	
D	± 0.5 pF	
F	± 1.0 pF	± 1%
G	± 2.0 pF	± 2%
H		± 3%
J		± 5%
K		± 10%
M		± 20%

EXAMPLES: 151 K = 15 X 10 = 150 pF
 759 = 75 X 0.1 = 7.5 pF

NOTE: The letter "R" may be used at times to signify a decimal point, as in: 2R2 = 2.2 (pF or μF).

RECTIFIER CIRCUIT BOARD

PARTS LIST

Refer to the Pack Index Sheet and locate Pack #1. Then remove the parts from this pack and check each part against the following list. The key numbers correspond to the numbers on the "Rectifier Circuit Board Parts Pictorial." If a part is packed in an individual envelope, with the part number on it, identify the part; then return it to the envelope until a step calls for it. Do not throw away any packing material until you account for all of the parts.

To order a replacement part, always include the PART NUMBER. Use the Parts Order Form furnished with this kit. If a Parts Order Form is

not available, refer to "Replacement Parts" inside the rear cover of this Manual.

A replacement part may look slightly different than the original part, or may have different printing on it. In any case, the performance of the replacement part will meet or exceed the requirements of the original part. For example: A 15-volt capacitor (10 μ F, 15 V) may be replaced with a 25-volt capacitor (10 μ F, 25 V).

KEY No.	HEATH Part No.	QTY.	DESCRIPTION	CIRCUIT Comp. No.
ELECTRONIC PARTS				
A1	230-6776	10	1N5408 diode	D301, D302, D303, D304, D305, D306, D307, D308, D309, D310
A2	21-70	10	.01 μ F ceramic capacitor	C301, C302, C303, C304, C305, C306, C307, C308, C309, C311
	85-3294-1	1	Rectifier circuit Board	

KEY No.	HEATH Part No.	QTY.	DESCRIPTION	CIRCUIT Comp. No.
WIRE--CABLE				
	340-1	30'	Large bare wire	
	340-9	12'	Medium bare wire	
	341-2	16'	Large red stranded wire	
	343-33	4'4"	Small coaxial cable	
	343-38	26"	Large coaxial cable	
	344-2	8'	Medium black stranded wire	
	344-7	3'3"	Large black stranded wire	
	344-50	3'	Small black solid wire	
	344-51	3'	Small brown solid wire	
	344-52	3'3"	Small red solid wire	
	344-53	30"	Small orange solid wire	
	344-54	30"	Small yellow solid wire	



STEP-BY-STEP ASSEMBLY

Refer to Pictorial 1-1 while you read the following notes and steps.

NOTES:

1. Many circuit board drawings, such as the one shown in Pictorial 1-1, are divided into two or more sections. You will work in each of these sections for a specific series of steps.
2. In each series of steps, you will install parts in a top-to-bottom, left-to-right sequence. Occasionally, you may be directed to install a part out of sequence.
3. Check off each step as you perform it. You may also wish to place a check mark near each component on the Pictorial as you install it.
4. In general, solder instructions are given only at the end of a series of similar steps. You may solder more often if you wish.

In the following steps, you will be given detailed instructions on how to install and solder the first part on the circuit board. Read and perform each step carefully. Then use the same procedure to install other parts on the circuit board.

Note that the circuit board has foil patterns on one side and the other side has outlines of components (parts) shown on it. The "foil" side of the circuit board will be referred to as such, and the side with the outlines will be called the "component" side of the board.

Section 1

- () Position the circuit board as shown in the Pictorial with the component side facing up. Always install components on the component side of the circuit board, and solder the leads to the foil on the other side unless a step specifically directs you otherwise.

NOTE: In the following steps you will install diodes. Whenever you install a diode, always match the banded end of the diode with the band mark on the circuit board. The circuit will not work properly if the diode is installed backwards.

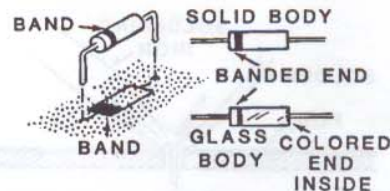
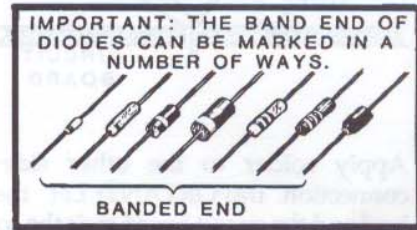

CAUTION: ALWAYS POSITION THE BANDED END OF A DIODE AS SHOWN ON THE CIRCUIT BOARD.

- () Hold a 1N5408 (#230-6776) diode as shown and bend the leads straight down.



- () D310: Start the leads into the circuit board holes at location D310 on the circuit board. Position the banded end of the diode over the outline of the banded end on the board.
- () Press the diode against the circuit board. Then bend the leads out slightly to hold it in place.



() Solder the diode leads to the foil as follows:

1. Push the soldering iron tip against both the lead and the circuit board foil. Heat both for two or three seconds.

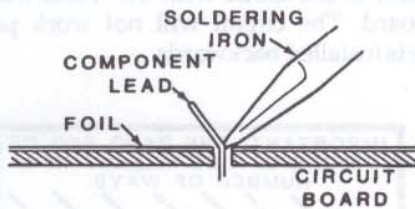

2. Apply solder to the other side of the connection. IMPORTANT: Let the heated lead and the circuit board melt the solder.

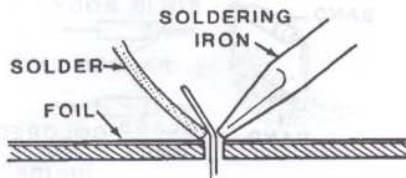

3. As the solder begins to melt, allow it to flow around the connection. Then remove the solder and the iron and let the connection cool.

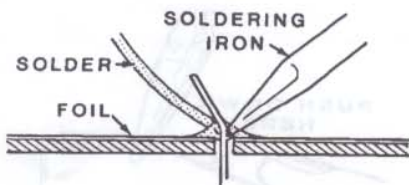

- () Cut off the excess lead lengths close to the connection. **WARNING:** Clip the leads so the ends will not fly toward your eyes.
- () Check the connection. Compare it to the illustrations in Detail 1-1A. After you have checked the connections, proceed with the following assembly. Use the same soldering procedure for each connection.

NOTE: Make sure you installed diode D310 on page 13.

Install a 1N5408 (#230-6776) diodes at each of the following four locations:

- () D309.
- () D308.
- () D307.
- () D306.

- () Solder the leads to the foil and cut off the excess lead lengths.

- () Push the longer end of the circuit board pin as far as possible into hole B. Then bend the end so it is flat against and within the indicated foil pattern. Make sure the other end of the pin is still perpendicular to the component side of the circuit board. Then solder the longer end to the foil. NOTE: You will have to scrape the foil around the pin before you solder it.

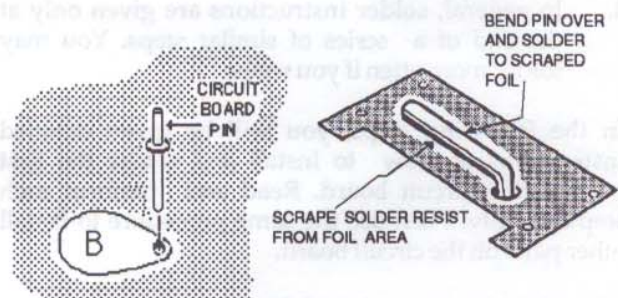

Section 2

Install a 1N5408 (#230-6776) diode at each of the following five locations:

- () D301.
- () D302.
- () D303.
- () D304.
- () D305.

- () Solder the leads to the foil and cut off the excess lead lengths.

Refer to Pictorial 1-2 while you perform the following steps.

Section 1

NOTE: In the next step, you will install a disk-type ceramic capacitor. When you install this type of capacitor, do not push the insulated portion of the leads into the circuit board holes. This could make it difficult to solder the leads to the foil.



Install a .01 μ F ceramic capacitor at each of the following five locations:

- () C311.
- () C309.
- () C308.
- () C307.
- () C306.
- () Solder the leads to the foil and cut off the excess lead lengths.

Section 2

Install a .01 μ F ceramic capacitor at each of the following five locations:

- () C301.
- () C302.
- () C303.
- () C304.
- () C305.
- () Solder the leads to the foil and cut off the excess lead lengths.

Refer to Pictorial 1-3 while you perform the following steps.

- () Reposition the circuit board foil-side-up as shown in the Pictorial.

NOTE: When you are instructed to prepare a wire, as in the following step, cut it to the indicated length and remove 1/4" of insulation from each end. If the wire is stranded, twist the fine wire strands tightly together and apply a small amount of solder to hold the strands together.

- () Prepare a 2-3/4" large red stranded wire and a 7" medium black stranded wire.
- () Push one end of the 2-3/4" large red stranded wire into hole C on the foil side of the circuit board (the hole is labeled on the other side of the board). Position the wire so the insulation is 1/8" above the foil as shown in the inset drawing on the Pictorial. Then solder the wire to the foil. The other end of this wire will be connected later. Cut off any excess wire end from the other side of the circuit board.
- () Similarly, solder one end of the 7" medium black stranded wire to hole A on the foil side of the circuit board. The other end of this wire will be connected later.

CIRCUIT BOARD CHECKOUT

Carefully inspect the foil side of the circuit board for the following most-commonly-made errors:

- () Unsoldered connections.
- () Poor solder connections.
- () Protruding leads which could touch together.
- () Check each diode to make sure it is properly installed.

This completes the assembly of the rectifier circuit board. Set it aside until it is called for in a step.



Refer to Figure 1-3 while you perform the following steps:

- (1) Reposition the circuit board leadwires as shown in the Figure.

NOTE: When you are instructed to prepare a wire as in the following step, cut it to the indicated length and remove 1/4" of insulation from each end. If the wire is stranded, twist the fine wire strands together and apply a small amount of solder to hold the strands together.

- (2) Prepare a 2-1/2" length of stranded wire and a 7" length of black wire.

(3) Push one end of the 2-1/2" wire into hole C on the foil side of the circuit board (the hole is labeled on the other side of the board). Position the wire as the insulation is 1/8" above the foil as shown in the next drawing on the Figure. Then solder the wire to the foil. The other end of the wire will be connected later. Cut off any excess wire and trim the other side of the circuit board.

- (4) Similarly solder one end of the 7" length of black stranded wire to hole A on the foil side of the circuit board. The other end of this wire will be connected later.

CIRCUIT BOARD CHECKOUT

Carefully repeat the foil side of the circuit board for the following instructions:

- (1) Inspected connections.
- (2) Iron solder connections.
- (3) Solder leads which could touch together.
- (4) Check each diode to make sure it is properly installed.

After completing the assembly of the Heathkit circuit board, it will be called for in a step.

Refer to Figure 1-2 while you perform the following steps:

Section 1

NOTE: In the next step you will install a disk-type ceramic capacitor. When you install this type of capacitor, do not push the insulated portion of the leads into the circuit board. This could cause it to be difficult to solder the leads to the foil.

INSULATION



Install a .01 microfarad ceramic capacitor at each of the following locations:

- (1) C101
- (2) C102
- (3) C103
- (4) C104
- (5) C105

- (6) Solder the leads to the foil and cut off the excess lead lengths.

Section 2

Install a .01 microfarad ceramic capacitor at each of the following locations:

- (1) C101
- (2) C102
- (3) C103
- (4) C104
- (5) C105

- (6) Solder the leads to the foil and cut off the excess lead lengths.



STEP-BY-STEP ASSEMBLY

Install a 50 kΩ 7- or 10-watt resistor in each of the following four positions. NOTE: Be sure to position an resistor in its body in the correct lead position.

FILTER CIRCUIT BOARD

PARTS LIST

Refer to the Pack Index Sheet and locate Pack #2. Then remove the parts from this pack and check each part against the following list. The key numbers correspond to the numbers on the "Filter Circuit Board Parts Pictorial." If a part is packed in an individual envelope, with the part number on it, identify the part; then return it to the envelope until a step calls for it. Do not throw away any packing material until you account for all of the parts.

To order a replacement part, always include the PART NUMBER. Use the Parts Order Form furnished with this kit. If a Parts Order Form is not

available, refer to "Replacement Parts" inside the rear cover of this Manual.

A replacement part may look slightly different than the original part, or may have different printing on it. In any case, the performance of the replacement part will meet or exceed the requirements of the original part. For example: A 15-volt capacitor (10 μF, 15 V) may be replaced with a 25-volt capacitor (10 μF, 25 V).

KEY No.	HEATH Part No.	QTY.	DESCRIPTION	CIRCUIT Comp. No.
---------	----------------	------	-------------	-------------------

ELECTRONIC PARTS

NOTE: The resistors in this pack have a tolerance of 5% unless otherwise noted. A 5% tolerance is indicated by a gold fourth color band (on resistors that have color bands).

A1	6-473	1	47 kΩ, 1/2-watt (yel-viol-org) resistor	R401
A2	230-6779	2	1 MΩ, 2-watt, 1% resistor (may be marked 1M or brn-blk-grn)	R403, R404
A2	230-6780	1	1.5 MΩ, 2-watt, 1% (brn-grn-grn) resistor	R402
A3	230-6778	8	50 KΩ, 7- or 10-watt resistor	R405, R406, R407, R408, R409, R411, R412, R413

KEY No.	HEATH Part No.	QTY.	DESCRIPTION	CIRCUIT Comp. No.
---------	----------------	------	-------------	-------------------

ELECTRONIC PARTS (Cont'd)

A4	21-769	2	.01 μF (103) axial-lead ceramic capacitor	C409, C411
A5	230-6777	8	210 μF electrolytic capacitor	C401, C402, C403, C404, C405, C406, C407, C408
A6	230-6776	1	1N5408 diode	D401
	85-3295-1	1	Filter circuit board	
A7	230-6781	1	Ferrite choke	L401

HARDWARE

B1	250-330	16	10-32 x 3/8" screw
B2	254-36	16	#10 lockwasher



STEP-BY-STEP ASSEMBLY

Refer to Pictorial 2-1 while you perform the following steps.

NOTE: You will install most of the parts on the foil side of this circuit board. For this reason, the outlines of the parts are printed on the foil side.

- () Position the circuit board as shown in the Pictorial.

Section 1

- () R404: 1 M Ω , 2-watt, 1% resistor (may be marked 1M or have brn-blk-grn color bands).
- () R403: 1 M Ω , 2-watt, 1% resistor (may be marked 1M or have brn-blk-grn color bands).

Install a 50 k Ω , 7- or 10-watt resistor at each of the following four locations. NOTE: Be sure to position each resistor so its body is 1/4" above the circuit board as shown. If the resistor body is longer than the circuit board hole spacing, form the leads under the body to fit.



- () R413.
- () R412.
- () R411.
- () R409.
- () Solder the leads to the foil and cut off the excess lead lengths.

Section 2

- () R402: 1.5 M Ω , 2-watt, 1% (brn-grn-grn) resistor. Mount this resistor down against the circuit board.
- () R401: 47 k Ω , 1/2-watt (yel-viol-org) resistor. Mount this resistor down against the circuit board.

Install a 50 k Ω , 7- or 10-watt resistor at each of the following four locations. NOTE: Be sure to position each resistor so its body is 1/4" above the circuit board.

- () R408.
- () R407.
- () R406.
- () R405.

NOTE: Mount the next four components down against the circuit board.

- () D401: 1N5408 (#230-6776) diode. Be sure to match the band on the diode with the outline of the band on the circuit board.
- () L401: Choke (#230-6781).
- () C409: .01 μ F (103) axial-lead ceramic capacitor.
- () C411: .01 μ F (103) axial-lead ceramic capacitor.
- () Solder the leads to the foil and cut off the excess lead lengths.

Refer to Pictorial 2-2 while you perform the following steps.

NOTES:

1. You will mount the following electrolytic capacitors on the plain side of the circuit board. The outlines of these capacitors are shown in dashed lines on the foil side of the board.
 2. Be sure you install each capacitor correctly. Once the capacitor is installed, it is difficult to check your work.
- () C407: Locate one of the 210 μ F electrolytic capacitors. Note that there is a positive (+) mark near one of its terminals. Be sure to position the capacitor so this positive (+) terminal is connected to the positive (+) marked circuit board foil as shown in Detail 2-2A. Use two 10-32 x 3/8" screws and two #10 lockwashers to mount the capacitor onto the plain side of the circuit board at C407.

Similarly use 10-32 x 3/8" screws and #10 lock-washers to mount 210 μ F electrolytic capacitors to the circuit board at the following seven locations. Be sure to position each capacitor so its positive (+) marked terminal is connected to the positive (+) marked circuit board foil.

- () C406.
- () C403.
- () C402.
- () C408.
- () C405.
- () C404.
- () C401.

CIRCUIT BOARD CHECKOUT

Carefully inspect the foil side of the circuit board for the following most-commonly-made errors:

- () Unsoldered connections.
- () Poor solder connections.
- () Solder bridges between foil patterns. If you wish, you can check your foil pattern against the one shown in the "X-Ray Views" beginning on Illustration Booklet Page 67.
- () Protruding leads which could touch together.

Refer to the illustrations where parts were installed as you make the following visual checks:

- () Diode for the proper installation.
- () Electrolytic capacitors for the correct position of the positive (+) marked terminal. NOTE: You can look between the capacitors and the circuit board to check this.

This completes the assembly of the filter circuit board. Set it aside until it is called for in a step.

ELECTRONIC PARTS (CONT'D)

Q1	1N4001	1	1N4001	1
Q2	1N4001	1	1N4001	1
Q3	1N4001	1	1N4001	1
Q4	1N4001	1	1N4001	1
Q5	1N4001	1	1N4001	1
Q6	1N4001	1	1N4001	1
Q7	1N4001	1	1N4001	1
Q8	1N4001	1	1N4001	1
Q9	1N4001	1	1N4001	1
Q10	1N4001	1	1N4001	1

ELECTRONIC PARTS

Q1	1N4001	1	1N4001	1
Q2	1N4001	1	1N4001	1
Q3	1N4001	1	1N4001	1
Q4	1N4001	1	1N4001	1
Q5	1N4001	1	1N4001	1
Q6	1N4001	1	1N4001	1
Q7	1N4001	1	1N4001	1
Q8	1N4001	1	1N4001	1
Q9	1N4001	1	1N4001	1
Q10	1N4001	1	1N4001	1

ALC/POWER CIRCUIT BOARD

PARTS LIST

Refer to the Pack Index Sheet and locate Pack #3. Then remove the parts from this pack and check each part against the following list. The key numbers correspond to the numbers on the "ALC/Power Circuit Board Parts Pictorial." If a part is packed in an individual envelope, with the part number on it, identify the part; then return it to the envelope until a step calls for it. Do not throw away any packing material until you account for all of the parts.

To order a replacement part, always include the PART NUMBER. Use the Parts Order Form furnished with this kit. If a Parts Order Form is not

available, refer to "Replacement Parts" inside the rear cover of this Manual.

A replacement part may look slightly different than the original part, or may have different printing on it. In any case, the performance of the replacement part will meet or exceed the requirements of the original part. For example: A 15-volt capacitor (10 μ F, 15 V) may be replaced with a 25-volt capacitor (10 μ F, 25 V).

KEY HEATH No. Part No.	QTY.	DESCRIPTION	CIRCUIT Comp. No.
---------------------------	------	-------------	----------------------

ELECTRONIC PARTS

NOTE: The resistors in this pack are rated at 1/2-watt and have a tolerance of 5%. A 5% tolerance is indicated by a gold fourth color band.

A1	6-181	2	180 Ω (brn-gry-brn) resistor	R101, R103
A1	6-473	1	47 k Ω (yel-viol-org) resistor	R102
A2	230-6783	2	10 pF ceramic capacitor	C101, C102

KEY HEATH No. Part No.	QTY.	DESCRIPTION	CIRCUIT Comp. No.
---------------------------	------	-------------	----------------------

ELECTRONIC PARTS (Cont'd)

A3	230-6782	1	27 pF (270) mica capacitor	C106
A3	20-103	2	150 pF (151) mica capacitor	C103, C107
A4	21-769	2	.01 μ F (103) axial-lead ceramic capacitor	C104, C105
A5	56-56	4	1N4149 diode	D101, D102, D103, D104
	85-3296-1	1	ALC/Power circuit board	

STEP-BY-STEP ASSEMBLY

Refer to Pictorial 3-1 while you perform the following steps.

- () Position the circuit board as shown in the Pictorial. NOTE: Be sure to install of the parts on the component side (not the foil side) of this circuit board.
- () R102: 47 kΩ, 1/2-watt (yel-viol-org) resistor.
- () D102: 1N4149 diode (#56-56). Be sure to match the band on the diode with the outline of the band on the circuit board.
- () D101: 1N4149 diode (#56-56).
- () C104: .01 μF (103) axial-lead ceramic capacitor.
- () C105: .01 μF (103) axial-lead ceramic capacitor.
- () D103: 1N4149 diode (#56-56).
- () D104: 1N4149 diode (#56-56).
- () R101: 180 Ω, 1/2-watt (brn-gry-brn) resistor.
- () R103: 180 Ω, 1/2-watt (brn-gry-brn) resistor.
- () Solder the leads to the foil and cut off the excess lead lengths.

Refer to Pictorial 3-2 while you perform the following steps.

- () C101: 10 pF ceramic capacitor.
- () C102: 10 pF ceramic capacitor.
- () C103: 150 pF (151) mica capacitor.
- () C106: 27 pF (270) mica capacitor.
- () C107: 150 pF (151) mica capacitor.
- () Solder the leads to the foil and cut off the excess lead lengths.

- () Prepare the following solid wires. NOTE: The wires are listed in the order in which you will use them.

2" orange
 6" ~~gray~~ orange/red stripe
 2" blue

NOTE: Solder one end of the following wires to the foil as you connect them. The other ends of these wires will be connected later.

- () Connect one end of the 2" orange solid wire to hole A.
- () Connect one end of the 6" gray solid wire to hole B.
- () Connect one end of the 2" blue solid wire to hole C.

CIRCUIT BOARD CHECKOUT

Carefully inspect the foil side of the circuit board for the following most-commonly-made errors.

- () Unsoldered connections.
- () Poor solder connections.
- () Solder bridges between foil patterns. If you wish, you can check your foil pattern against the one shown in the "X-Ray Views" beginning on Illustration Booklet Page 67.
- () Check each diode to make sure it is correctly installed.

This completes the assembly of the ALC/power circuit board. Set it aside until it is called for in a step.

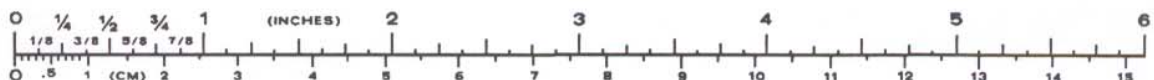

STEP-BY-STEP ASSEMBLY

METER CIRCUIT BOARD

PARTS LIST

Refer to the Pack Index Sheet and locate Pack #4. Then remove the parts from this pack and check each part against the following list. The key numbers correspond to the numbers on the "Meter Circuit Board Parts Pictorial." If a part is packed in an individual envelope, with the part number on it, identify the part; then return it to the envelope until a step calls for it. Do not throw away any packing material until you account for all of the parts.

To order a replacement part, always include the PART NUMBER. Use the Parts Order Form furnished with this kit. If a Parts Order Form is not

available, refer to "Replacement Parts" inside the rear cover of this Manual.

A replacement part may look slightly different than the original part, or may have different printing on it. In any case, the performance of the replacement part will meet or exceed the requirements of the original part. For example: A 15-volt capacitor (10 μ F, 15 V) may be replaced with a 25-volt capacitor (10 μ F, 25 V).

KEY HEATH No. Part No.	QTY.	DESCRIPTION	CIRCUIT Comp. No.
---------------------------	------	-------------	----------------------

RESISTORS

NOTE: The resistors in this pack are rated at 1/2-watt and have a tolerance of 5% unless otherwise listed. A 5% tolerance is indicated by a gold fourth color band.

A1	230-6786	1	.6 Ω , 3-watt, 1% resistor	R202
A1	230-6787	1	1.5 Ω , 3-watt, 1% resistor	R203
A2	6-100	1	10 Ω (brn-blk-blk) resistor	R201
A2	6-103	1	10 k Ω (brn-blk-org) resistor	R206
A2	6-153	1	15 k Ω (brn-grn-org) resistor	R205
A2	6-333	1	33 k Ω (org-org-org) resistor	R207

KEY HEATH No. Part No.	QTY.	DESCRIPTION	CIRCUIT Comp. No.
---------------------------	------	-------------	----------------------

CAPACITORS

B1	21-769	2	.01 μ F (103) axial-lead ceramic capacitor	C201, C203
B2	25-917	1	10 μ F electrolytic capacitor	C202
B2	25-951	1	1000 μ F electrolytic capacitor	C204

MISCELLANEOUS

C1	10-941	1	100 k Ω control	R204
C2	230-6784	1	Bridge rectifier	D201
C3	417-875	1	2N3904 transistor	Q201
C4	230-6785	1	Rotary switch	SW201
C5	354-5	2	Cable tie	
	85-3297-1	1	Meter circuit board	

STEP-BY-STEP ASSEMBLY

Refer to Pictorial 4-1 while you perform the following steps.

NOTE: This circuit board has foil patterns on both sides, but only one side has the outlines of the components (parts) shown on it. Be sure to install the following components on the side of the circuit board that has the outlines on it, and solder the leads to the foil on the other side, unless a specific step directs you otherwise.

Section 1

- () R202: 0.6 Ω , 3-watt, 1% resistor.
- () R205: 15 k Ω , 1/2-watt (brn-grn-org) resistor.
- () C201: .01 μ F (103) axial-lead ceramic capacitor.
- () R206: 10 k Ω , 1/2-watt (brn-blk-org) resistor.
- () R203: 1.5 Ω , 3-watt, 1% resistor.
- () Solder the leads to the foil and cut off the excess lead lengths.

Section 2

- () R207: 33 k Ω , 1/2-watt (org-org-org) resistor.
- () C203: .01 μ F (103) axial-lead ceramic capacitor.
- () R201: 10 Ω , 1/2-watt (brn-blk-blk) resistor.
- () Solder the leads to the foil and cut off the excess lead lengths.

Refer to Pictorial 4-2 while you perform the following steps.

Section 1

- () Q201: 2N3904 transistor (#417-875). Position the flat side of the transistor over the outline of the flat on the circuit board. Then start the leads into their corresponding holes. Position

the transistor 1/4" above the circuit board. Then solder the leads to the foil and cut off any excess lead lengths.

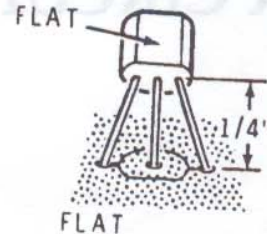

- () C202: 10 μ F electrolytic capacitor. Before you install an electrolytic capacitor, look at it and identify the leads. One lead will have a positive (+) mark or a negative (-) mark near it on the side of the capacitor. (The marking for a negative lead may look like an oblong bar, sometimes with a circle around it, inside an arrow.) Be sure to install the positive lead in the positive-marked hole, or the negative lead in the negative-marked hole.

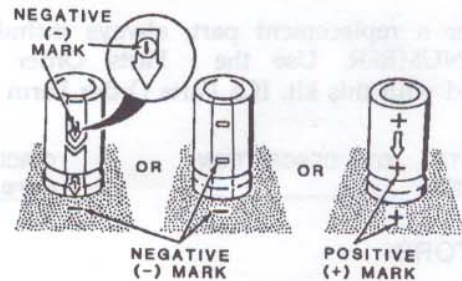

- () R204: 100 k Ω control. Start the lugs into the circuit board holes and push the control down tight against the board. Then solder the lugs to the foil.



Section 2

- () D201: Bridge rectifier. Match the dot-marked (or longer) lead of the rectifier with the dot on the circuit board. Then start the leads into their corresponding circuit board holes. Position the rectifier 1/8" above the circuit board. Then solder the leads to the foil and cut off any excess lead lengths.

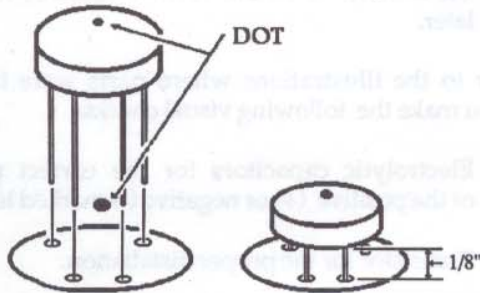

- () C204: 1000 μ F electrolytic capacitor. Be sure to observe the correct polarity. Solder the leads to the foil and cut off the excess lead lengths.

Refer to Pictorial 4-3 while you perform the following steps.

- () Reposition the circuit board with the foil-side-up as shown in the Pictorial.

NOTE: Do not remove the hardware from the switch bushing until a step directs you to do so.

- () SW201: Refer to Detail 4-3A and use the following procedure to install the rotary switch:

1. Start the lugs of the switch into their corresponding holes on the **foil side** of the circuit board. Be sure to match the letter ① on the switch with the index mark on the other side of the circuit board.
2. Push the switch down tight against the circuit board. Then solder the lugs to the foil on the component side.

- () Prepare the following lengths of solid wire:

Three 6" yellow
One 19" orange

One 4" black
One 10" blue
One 23" gray
One 11" red
One 25" brown
One 21" red
One 6" orange
One 5-1/2" red
One 5-1/2" brown

NOTE: Install each of the following wires on the foil side of the circuit board and solder it on the component side as you connect it. The other ends of these wires will be connected later.

- () 6" yellow solid to hole C.
- () 6" yellow solid to hole R.
- () 19" orange solid to hole D.
- () 4" black solid to hole E.
- () 10" blue solid to hole F.
- () 11" red solid to hole K.
- () 6" yellow solid to hole N.
- () 25" brown solid to hole L.
- () 6" orange solid to hole M.
- () 21" red solid to hole H.
- () 23" gray solid to hole G.
- () Form a hook in one end of the 5-1/2" red solid wire. Then refer to Detail 4-3B and solder the end of the wire to rotary switch SW201 lug P.
- () Form a hook in one end of the 5-1/2" brown solid wire. Then refer to Detail 4-3B and solder the end of the wire to rotary switch SW201 lug Q.
- () Loosely (approximately one-turn-per inch) twist together the 6" orange and yellow wires coming from circuit board holes M and N.
- () Similarly, loosely twist together the 5-1/2" red and brown wires coming from circuit board holes P and Q.

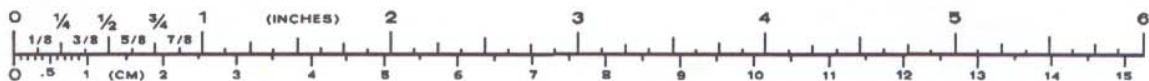

Refer to Pictorial 4-4 while you perform the following steps.

- () Reposition the circuit board as shown in the Pictorial.
- () Route the black, blue, and red wires coming from circuit board holes E, F and K toward the left as shown. Then route the remaining wires toward the right as shown.
- () Refer to the inset drawing on the Pictorial and install two cable ties around the wires coming from the circuit board in the areas shown. Pull the cable ties tight and cut off the excess tie.

CIRCUIT BOARD CHECKOUT

Carefully inspect the foil side of the circuit board for

the following most-commonly-made errors:

- () Unsoldered connections.
- () Poor solder connections.
- () Solder bridges between foil patterns.
- () Protruding leads which could touch together or the chassis when the circuit board is mounted later.

Refer to the illustrations where parts were installed as you make the following visual checks:

- () Electrolytic capacitors for the correct position of the positive (+) or negative (-) marked lead.
- () Transistor for the proper installation.
- () Bridge rectifier for the proper installation.

This completes the assembly of the meter circuit board. Set it aside until it is called for in a step.



INPUT FILTER

PARTS LIST

Refer to the Pack Index Sheet and locate Pack #5. Then remove the parts from this pack and check each part against the following list. The key numbers correspond to the numbers on the "Input Filter Parts Pictorial." If a part is packed in an individual envelope, with the part number on it, identify the part; then return it to the envelope until a step calls for it. Do not throw away any packing material until you account for all of the parts.

To order a replacement part, always include the PART NUMBER. Use the Parts Order Form furnished with this kit. If a Parts Order Form is not

available, refer to "Replacement Parts" inside the rear cover of this Manual.

A replacement part may look slightly different than the original part, or may have different printing on it. In any case, the performance of the replacement part will meet or exceed the requirements of the original part. For example: A 15-volt capacitor (10 F, 15 V) may be replaced with a 25-volt capacitor (10 F, 25 V).

KEY HEATH	QTY.	DESCRIPTION	CIRCUIT
No.	Part No.		Comp. No.

CAPACITORS

A1	20-100	1	30 pF mica	C17
A1	20-76	1	68 pF mica	C15
A1	20-102	1	100 pF (101) mica	C16
A1	20-183	1	120 pF (121) mica	C13
A1	20-103	1	150 pF (151) mica	C14
A1	20-120	1	220 pF (221) mica	C12
A1	20-131	1	360 pF (361) mica	C11
A1	20-158	1	500 pF (501) mica	C9
A1	20-171	1	820 pF (821) mica	C8
A1	20-122	1	1000 pF (102) mica	C7
A1	230-6821	1	2700 pF (272) mica	C6
A1	20-150	1	3300 pF (332) mica	C5

COILS

B1	230-6788	1	160-meter coil (28 turns)	L1
B2	230-6789	1	80-meter coil (21 turns)	L2
B3	230-6790	1	40-meter coil (14-1/2 turns)	L3

KEY HEATH	QTY.	DESCRIPTION	CIRCUIT
No.	Part No.		Comp. No.

COILS (Cont'd)

B4	230-6791	1	20-meter coil (9 turns)	L4
B5	230-6792	1	15-meter coil (5-1/2 turns)	L5
B6	230-6793	1	10-meter coil (3-1/2 turns)	L6
B7	230-6800	1	Toroid coil	L9
B8	230-6815	1	2.5 mH RF choke	RFC1

OTHER ELECTRONIC PARTS

C1	63-1426	1	Rotary switch wafer	SW2A, SW2B
C2	63-1422	1	Rotary switch	SW2C, SW2D, SW2E

KEY HEATH QTY. DESCRIPTION
No. Part No. _____
CIRCUIT
Comp. No. _____

HARDWARE

D1	250-480	2	4-40 x 15/16" screw
D2	250-1280	1	6-32 x 3/8" screw
D3	252-15	2	4-40 nut
D4	252-3	2	6-32 nut
D5	254-41	4	#4 split lockwasher
D6	254-1	1	#6 lockwasher
D7	255-784	2	3/8" spacer
D8	259-9	2	#4 solder lug

KEY HEATH QTY. DESCRIPTION
No. Part No. _____
CIRCUIT
Comp. No. _____

HARDWARE (Cont'd)

D9	259-1	1	#6 solder lug
D10	259-24	1	Long #8 solder lug

MISCELLANEOUS

E1	73-4	1	Rubber grommet
E2	204-3075	1	Input chassis
E3	490-5	1	Nut starter

PARTS LIST

available under the "Replacement Parts" heading in the
new copies of this Manual.

A replacement part may look slightly different than
the original part, or may have different markings on
it. In any case, the performance of the replacement
part will meet or exceed the requirements of the
original part. For example, a 15-volt capacitor (C1
E-15) may be replaced with a 25-volt capacitor
(C10 E-25V).

Refer to the Jack Index Sheet and locate Jack #2.
Then remove the parts from the pack and check
each part against the following list. The key
numbers correspond to the numbers on the Input
Filter Manual. If a part is listed in an
additional envelope with the part number on it,
insert the part then return it to the envelope
until a step calls for it. Do not bring away any
padding material, with you account for all of the
parts.

In order a replacement part always include the
PART NUMBER. Use the Parts Order Form
included with this kit if a Parts Order Form is not

KEY HEATH QTY. DESCRIPTION
No. Part No. _____
CIRCUIT
Comp. No. _____

COILS (Cont'd)

C4	250-8751	1	20-mv coil (25 mv)
C5	250-8752	1	15-mv coil (15 mv)
C6	250-8753	1	10-mv coil (10 mv)
C7	250-8800	1	7-mv coil
C8	250-8813	1	2.5-mv coil

OTHER ELECTRONIC PARTS

C1	25-145	1	100-ohm resistor
C2	25-145Z	1	100-ohm resistor

C9
C10
C11
C12
C13

KEY HEATH QTY. DESCRIPTION
No. Part No. _____
CIRCUIT
Comp. No. _____

CAPACITORS

C1	25-100	1	50-ohm coil
C2	25-100Z	1	50-ohm coil
C3	25-100Z	1	50-ohm coil
C4	25-100Z	1	50-ohm coil
C5	25-100Z	1	50-ohm coil
C6	25-100Z	1	50-ohm coil
C7	25-100Z	1	50-ohm coil
C8	25-100Z	1	50-ohm coil
C9	25-100Z	1	50-ohm coil
C10	25-100Z	1	50-ohm coil
C11	25-100Z	1	50-ohm coil
C12	25-100Z	1	50-ohm coil
C13	25-100Z	1	50-ohm coil
C14	25-100Z	1	50-ohm coil
C15	25-100Z	1	50-ohm coil
C16	25-100Z	1	50-ohm coil
C17	25-100Z	1	50-ohm coil
C18	25-100Z	1	50-ohm coil
C19	25-100Z	1	50-ohm coil
C20	25-100Z	1	50-ohm coil

COILS

C1	25-100Z	1	50-ohm coil (25 mv)
C2	25-100Z	1	50-ohm coil (15 mv)
C3	25-100Z	1	50-ohm coil (10 mv)

STEP-BY-STEP ASSEMBLY

Refer to Pictorial 5-1 while you perform the following steps.

- (✓) Position the input chassis as shown in the Pictorial.
- (✓) Install a rubber grommet in chassis hole FA.

NOTE: You may wish to use tape (not supplied) to temporarily secure the screws that you will install in the next two steps.

- (✓) Slide a #4 split lockwasher onto a 4-40 x 15/16" screw. Then, from outside the chassis, push the screw into hole FB.
- (✓) Similarly slide a #4 lockwasher onto a 4-40 x 15/16" screw and push the screw into hole FC.
- (✓) Temporarily remove the control nut and control lockwasher from the rotary switch. NOTE: Be sure the switch detent rings stay on the switch and remain in position while you perform the next step.
- (✓) SW2C, SW2D, & SW2E: Line up the locating tab on the rotary switch with its corresponding hole in the chassis. Then use the control nut and control lockwasher (removed earlier) to mount the switch on the outside of the chassis.

- (✓) Rotate the shaft of the rotary switch fully counterclockwise (as viewed from the shaft side of the switch). Now compare the rear switch wafer with the one shown in Detail 5-1A Part A. The wiper should make contact with the indicated switch contacts. Rotate the shaft of the switch clockwise and make sure the switch has six positions (five clicks). NOTE: Perform steps 1 through 7 only if the wiper does not make contact with the correct contacts, or if the switch has more or less than six positions:

1. Turn the shaft of the switch fully counterclockwise.
2. Temporarily remove the rotary switch from the chassis.

3. Temporarily remove the two detent rings from the switch.

4. Check the rear switch wafer against the one shown in Detail 5-1A Part A. If the wiper does not make contact with the indicated contacts, rotate the shaft of the switch until it does. NOTE: Do not change the position of the shaft until you complete step #7 below.

5. Position the rotary switch as shown so the locating tab is on the right as shown in Detail 5-1A Part B. Then reinstall the detent rings so they are in slots 6 and 12. NOTE: Make sure the rings stay in these positions while you perform step 6.

6. Remount the rotary switch to the chassis and recheck it for six positions.

7. Recheck the switch as you were directed at the beginning of this step.

- (✓) Slide #4 solder lugs onto the screws at FB and FC. Then slide a 3/8" spacer onto each of the screws.

NOTE: Use the plastic nut starter to hold and start 4-40 and 6-32 nuts on screws.

- (✓) Carefully slide the rotary switch wafer onto the shaft of the rotary switch and screws FB and FC as shown (the switch can be installed either way, as long as the side with twelve lugs is away from the chassis). Then use #4 split lockwashers and 4-40 nuts to secure the switch at FB and FC. NOTE: Be sure to position the solder lugs at FB and FC as shown in the Pictorial before you tighten the hardware.

- (✓) Use a 6-32 x 3/8" screw and a 6-32 nut to mount a #6 solder lug on the inside of the chassis at FD. Be sure to position the solder lug as shown in the Pictorial before you tighten the hardware.

Refer to Pictorial 5-2 while you perform the following steps.

- (✓) Refer to Detail 5-2A and prepare a 20" small coaxial cable. Use this cable in the next step.

- ✓ C7: Connect a 1000 pF (102) mica capacitor from coil L2 lug 2 (NS) to the bottom hole in solder lug FD (S-2). NOTE: You will connect wires to the top hole in this solder lug later.
- ✓ C5: Connect a 3300 pF (332) mica capacitor from coil L1 lug 2 (NS) to the top hole in solder lug FD (NS).
- ✓ C6: Connect a 2700 pF (272) mica capacitor from coil L1 lug 1 (NS) to the top hole in solder lug FD (S-2). NOTE: Two wires were previously soldered to the bottom hole in this solder lug.

Refer to Pictorial 5-4 while you perform the following steps.

NOTE: When a step directs you to prepare a solid wire, first cut the wire to the indicated length. Then remove 1/4" of insulation from each end.

- ✓ Prepare the following lengths of small black solid wire. The wires are listed in the order in which you will use them.

- ✓ 3"
- ✓ 2-1/2"
- ✓ 2-1/2"
- ✓ 2-1/2"
- ✓ 3-1/4"
- ✓ 3-3/4"
- ✓ 3-1/2"
- ✓ 3-1/4"
- ✓ 2-1/4"
- ✓ 3"

- ✓ Route one end of a 3" black solid wire through grommet FA and connect it to coil L6 lug 1 (NS). The other end of this wire will be connected later.
- ✓ Connect a 2-1/2" black solid wire from coil L6 lug 1 (S-3) to switch SW2A/SW2B lug 14 (S-1).
- ✓ Connect a 2-1/2" black solid wire from coil L6 lug 2 (S-2) to switch SW2A/SW2B lug 7 (S-1).
- ✓ Connect one end of a 2-1/2" black solid wire to coil L5 lug 1 (S-2). The other end of this wire will be connected later.
- ✓ Connect a 3-1/4" black solid wire from coil L4 lug 2 (S-2) to switch SW2A/SW2B lug 12 (S-1).

- ✓ Connect a 3-3/4" black solid wire from coil L1 lug 2 (S-2) to switch SW2A/SW2B lug 1 (S-1).
- ✓ Connect a 3-1/2" black solid wire from coil L1 lug 1 (S-2) to switch SW2A/SW2B lug 8 (S-1).
- ✓ Connect a 3-1/4" black solid wire from coil L2 lug 2 (S-2) to switch SW2A/SW2B lug 3 (S-1).
- ✓ Connect a 2-1/4" black solid wire from coil L2 lug 1 (S-2) to switch SW2A/SW2B lug 10 (S-1).
- ✓ Connect a 3" black solid wire from coil L3 lug 2 (S-2) to switch SW2A/SW2B lug 4 (S-1).
- ✓ Connect the free end of the wire coming from coil L5 lug 1 to switch SW2A/SW2B lug 13 (S-1).
- ✓ Position all wires away from the rotary switch shaft and the rotor so they do not rub when you turn the shaft. Also make sure switch lugs 1, 7, 8, and 14 do not touch the switch mounting hardware.

Refer to Pictorial 5-5 while you perform the following steps:

- () Reposition the input chassis as shown in the Pictorial.

NOTE: The inset drawing on the Pictorial shows you how the rotary switch lugs are numbered. Each position is numbered, even if there is no lug at that position.

- ✓ Cut a 1-3/4" length of large bare wire. Then use pliers to flatten at least half of its length so it will fit into the holes in the rotary switch lugs.
- ✓ Pass the flattened end of the 1-3/4" large bare wire through switch SW1D lug 1 to switch SW1E lug 1 (both lugs). Leave about 1" of bare wire extending from SW1D lug 1. Then solder the wire to all three lugs.
- ✓ L9: Refer to Detail 5-5A and use the following procedure to mount the toroid coil to the input chassis:

1. Use a knife or screwdriver blade to clean away any excess tar from the mounting hole of the toroid coil.

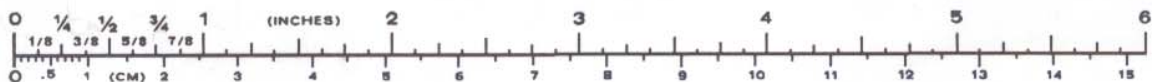

2. Slide a #6 lockwasher onto the screw on the outside of the chassis at FD.
 3. Use a 6-32 nut to mount the toroid coil onto the chassis at FD. Be sure to orient the coil so the center-tap lead is in the position shown in the Pictorial. The other two wires may exit the coil in positions that are different from those shown.
- ✓ Cut the center-tap toroid coil lead to 4-1/4", if this has not already been done. If the center-tap lead has insulation, remove 1/4" of the insulation from the end. If the lead does not have insulation, cut a 4" length of sleeving and slide it onto the lead. Now connect the lead to switch SW1D lug 12 (S-1).
 - ✓ Connect the longer remaining toroid coil lead (if the leads of your toroid are the same length, use either lead) to switch SW1D lug 11 (NS). Cut the lead as necessary to reach the lug and remove 1/4" of insulation from its end.
 - ✓ Connect the remaining toroid coil lead to the bare wire that is connected between switch SW1D lug 1 and SW1E lug 1 (S-1). Cut the lead as necessary to reach the lug and remove 1/4" of insulation from its end.
 - ✓ RFC1: Cut both leads of a 2.5 mH RF choke to 1/2". Then connect one lead to switch SW1D lug 11 (NS). Position the choke as shown in the Pictorial. Solder the other choke lead to the switch frame in the indicated area.

- ✓ Cut a 1-3/4" medium bare wire. Use this wire in the next step.
- ✓ Refer to inset drawing #2 and pass one end of the 1-3/4" bare wire through switch SW1C lug 7 (both lugs). Leave about 1" of wire extending through the lugs (away from the chassis). Then solder the other end of the bare wire to the switch frame in the indicated area. Solder the wire to both lugs at SW1C lug 7.
- ✓ Refer to inset drawing #3 and cut a long #8 solder lug to 5/8". Then pass the narrow end of the solder lug through switch SW1E lug 11 (both lugs). Solder the lug to both switch lugs.

INPUT FILTER CHECKOUT

Carefully inspect the input filter chassis for the following most-commonly-made errors:

- ✓ Unsoldered connections. NOTE: Lug 11 of switch SW1D will be soldered later.
- ✓ Poor solder connections.
- ✓ Protruding leads that could touch together, the chassis, or other lugs to which they are not connected.
- ✓ Protruding leads and rotary switch solder connections that could touch the switch mounting hardware.

This completes the assembly of the input filter. Shake out any solder globs or other foreign matter which may be lodged in the wiring. Then set the filter aside until it is called for in a step.

CHASSIS

PARTS LIST

Unpack the remainder of the kit and check each part against the following list. The key numbers correspond to the numbers on the "Chassis Parts Pictorial." If a part is packed in an individual envelope, with the part number on it, identify the part; then return it to the envelope until a step calls for it. Do not throw away any packing material until you account for all of the parts.

To order a replacement part, always include the PART NUMBER. Use the Parts Order Form furnished with this kit. If a Parts Order Form is not

available, refer to "Replacement Parts" inside the rear cover of this Manual.

A replacement part may look slightly different than the original part, or may have different printing on it. In any case, the performance of the replacement part will meet or exceed the requirements of the original part. For example: A 15-volt capacitor (10 μ F, 15 V) may be replaced with a 25-volt capacitor (10 μ F, 25 V).

KEY HEATH No.	PART No.	QTY.	DESCRIPTION	CIRCUIT Comp. No.
CAPACITORS				
Ceramic				
A1	21-176	3	.01 μ F, 100-volt	C1, C2, C3
A1	21-16	4	.01 μ F, 500-volt	C18, C19, C21, C22
A1	21-79	3	.001 μ F (1000 pF), 6000-volt	C23, C24, C25
A1	21-6	1	27 pF	C4
A1	21-821	2	4700 pF (472)	C32, C33
A2	230-6801	2	170 pF, 7500-volt doorknob	C26, C29
A2	230-6802	1	500 pF, 7500-volt doorknob	C28

KEY HEATH No.	PART No.	QTY.	DESCRIPTION	CIRCUIT Comp. No.
Variable				
A3	²⁶⁻¹⁷⁴ 230-6803	1	Plate capacitor (AR-112)	C27
A4	²⁶⁻¹⁷³ 230-6804	1	Load capacitor (AR-573)	C31
CHOKES-COILS				
B1	230-6795	1	160 & 80-meter tank coil	L8
B2	230-6796	1	40, 20, 15, & 10-meter tank coil	L7
B3	230-6797	1	Filament choke	RFC2
B4	230-6798	1	Plate choke	RFC3

KEY HEATH No. Part No.	QTY.	DESCRIPTION	CIRCUIT Comp. No.
---------------------------	------	-------------	----------------------

KEY HEATH No. Part No.	QTY.	DESCRIPTION	CIRCUIT Comp. No.
---------------------------	------	-------------	----------------------

OTHER ELECTRONIC PARTS

C1	1-20-2	1	100 Ω, 2-watt (brn-blk-brn) resistor	PC1
C2	3-21-7	2	4700 Ω (4.7 kΩ), 7-watt wire-wound resistor	R4A, R4B
C3	6-330	1	33 Ω, 1/2-watt (org-org- blk) resistor	R3
C3	6-473	1	47 kΩ, 1/2-watt (yel-viol-org) resistor	R1
C4	230-6794	1	7.5-volt, 10-watt zener diode	D2
C5	230-6816	1	100 kΩ control	R2
C6	230-6818	4	Lamp (with leads)	PL1, PL2, PL3, PL4
C7	69-116	1	DPST relay	K2
C8	230-6806	1	3PDT relay	K1
C9	230-6805	1	Interlock switch	SW4
C10	230-6819	2	Rocker switch	SW1, SW3
C11	230-6809	1	Fan	B1
C12	230-6810	1	Power transformer	T1
C13	230-6811	1	Multimeter	M2
C14	230-6812	1	Grid meter	M1
C15	411-245	1	3-500Z tube	V1
C16	412-640	1	LED (light-emitting diode)	D1
C17	421-53	2	10-ampere fuse (for 240 VAC operation)	F1, F2
C17	421-7	2	15-ampere fuse (for 120 VAC operation)	F1, F2

HARDWARE

NOTE: Hardware packets are marked to show the size of the hardware they contain (HDW #4, or HDW #6, etc.). You may have to open more than one packet to locate all of the hardware of any one size (#6, for example).

#4 Hardware

D1	250-1412	12	4-40 x 3/8" screw
D2	252-2	12	4-40 nut
D3	253-103	2	#4 fiber flat washer
D4	254-9	13	#4 lockwasher
D5	259-6	1	#4 plain solder lug

#6 Hardware

E1	250-1282	1	6-32 x 1/8" setscrew
E2	250-230	6	6-32 x 3/16" setscrew
E3	250-1508	3	6-32 x 3/16" screw
E4	250-1325	50	6-32 x 1/4" screw
E5	250-1280	14	6-32 x 3/8" screw

#6 Hardware (Cont'd)

E6	250-1425	12	6-32 x 1/2" screw
E7	250-1331	5	6-32 x 5/8" screw
E8	250-79	10	6-32 x 1-1/4" screw
E9	251-7	1	6-32 spade bolt
E10	252-3	41	6-32 nut
E11	253-1	8	#6 fiber flat washer
E12	253-82	4	#6 steel flat washer
E13	254-1	76	#6 lockwasher
E14	259-1	20	#6 solder lug

#8 & #10 Hardware

F1	250-1394	4	8-32 x 1/4" screw
F2	259-2	2	#8 solder lug
F3	250-54	1	10-32 x 5/8" screw
F4	252-5	1	10-32 steel nut
F5	252-163	1	10-32 wing nut
F6	252-199	5	10-32 brass nut
F7	253-98	2	#10 flat washer
F8	254-3	2	#10 lockwasher
F9	259-5	3	#10 solder lug
F10	259-26	1	#10 wire lug

Other Hardware

G1	250-1568	1	1/4"-20 x 1/2" screw
G2	250-334	4	1/4" x 1" screw
G3	252-39	3	Small control nut
G4	252-57	4	1/4" nut
G5	253-31	4	1/4" flat washer
G6	254-18	4	1/4" split lockwasher
G7	254-5	1	Large control lockwasher
G8	254-14	1	Small control lockwasher
G9	259-12	3	Small control solder lug
G10	255-49	6	5/16" spacer
G11	255-15	4	1/2" Spacer
G12	255-5	4	3/4" spacer
G13	255-868	6	4-1/2" spacer
G14	255-870	2	1" nylon spacer
G15	230-6817	1	Nylon flat washer

SHEET METAL PARTS

H1	90-1390-1	1	Cabinet top
H2	200-1548	1	Main chassis
H3	203-2334-1	1	Front panel
H4	203-2335	1	Front subpanel
H5	203-2336-1	1	Rear panel
H6	203-2337	1	Center panel
H7	216-88	2	Short trim strip
H8	216-89	2	Long trim strip



KEY HEATH QTY. DESCRIPTION CIRCUIT
No. Part No. _____ Comp. No. _____

CONNECTORS—SOCKETS

J1	432-137	4	Push-on connector
J2	432-866	2	Spring connector
J3	432-1030	1	2-pin socket shell
J4	434-389	3	Phono socket
J5	434-93	1	Tube socket
J6	436-5	2	Coaxial socket

TERMINAL STRIPS—FUSEHOLDERS

K1	423-17	2	Fuseholder body
K2	423-18	2	Fuseholder cap
K3	423-19	2	Fuseholder nut
K4	423-21	2	Fuseholder washer
K5	431-10	1	3-lug terminal strip
K6	431-12	2	4-lug terminal strip
K7	431-15	1	1-lug terminal strip
K8	431-41	2	2-lug terminal strip

KEY HEATH QTY. DESCRIPTION CIRCUIT
No. Part No. _____ Comp. No. _____

MISCELLANEOUS

	89-68	1	Line cord
L1	75-857	1	Strain relief
L2	75-860	1	Insulator paper (2-1/2" x 2-1/2")
L3	230-6807	2	Pointer
L4	230-6808	1	Barrier strip
L5	100-1608	2	Vernier drive
L6	207-18	3	Cable clamp
L7	260-12	1	Anode connector
L8	260-65	4	Lamp clip
L9	260-700	1	LED grommet
L10	260-701	1	LED retainer
L11	261-61	4	Foot
L12	352-13	1	Silicone grease
L13	354-5	11	Cable tie
L14	462-1237	3	Large knob
L15	462-1236	1	Small knob
L16	490-1	1	Coil alignment tool
L17	490-14	1	Allen wrench
L18	490-71	1	Control alignment tool

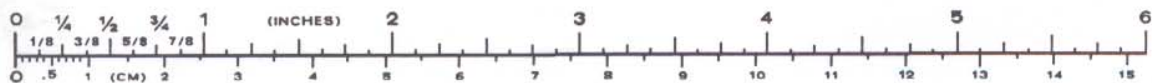

STEP-BY-STEP ASSEMBLY

REAR PANEL

Refer to Pictorial 6-1 while you perform the following steps.

- () Position the rear panel as shown in the Pictorial.

NOTE: When a step calls for hardware, only the screw size will be given. For example, if a step calls for "6-32 x 1/4" hardware," it means you should use a 6-32 x 1/4" screw, one or more lockwashers, and a 6-32 nut at the indicated location. Refer to the illustration (Pictorial or Detail) for the proper number and placement of each hardware item.

- (✓) J2: Refer to Detail 6-1A and use 4-40 x 3/8" hardware to mount a coaxial socket onto the inside of the rear panel at J2. Be sure to position the socket so the open side of the lug is toward the top of the rear panel.

- (✓) J1: Similarly, use 4-40 x 3/8" hardware to mount a coaxial socket onto the inside of the rear panel at J1. Be sure to position the socket so the open side of the lug is toward the top of the rear panel.

NOTE: Use care when you bend the solder lugs in the next step. They are very brittle and break easily.

- (✓) Locate three small control solder lugs. Then refer to inset drawing #1 on Detail 6-1B and bend the lugs enough so you can connect a wire to them after they are mounted onto the rear panel. Use these control solder lugs in the next three steps.

- (✓) J3: Refer to Detail 6-1B and mount a phono socket onto the rear panel at J3. Use a small control nut and a prepared small control solder lug. Be sure to position the socket so the lug is toward the top of the panel. Also be sure to position the solder lug as shown in the Pictorial before you tighten the hardware.

- (✓) J4: Similarly mount a phono socket and a small control solder lug onto the rear panel at J4. Be sure to position the socket and the solder lug as shown in the Pictorial before you tighten the hardware.

- (✓) J5: Similarly mount a phono socket and a small control solder lug onto the rear panel at J5. Be sure to position the socket and the solder lug as shown in the Pictorial before you tighten the hardware.

- (✓) R2: Refer to Detail 6-1C and use the following procedure to mount a 100 kΩ control onto the inside of the rear panel:

1. If your control has a small locating tab on one side, carefully bend it back and forth until it breaks off.
2. Use one of the flat washers and the nut supplied with the control and a large control lockwasher to mount the control to the rear panel at R2. Be sure to position the control as shown in the Pictorial before you tighten the hardware. Discard the extra flat washer that was supplied with the control.

- (✓) Refer to Detail 6-1D and use 6-32 x 1/4" hardware to mount a #6 solder lug onto the inside of the rear panel at RA. Be sure to position the solder lug as shown in the Pictorial before you tighten the hardware.

- (✓) Refer to Detail 6-1E and mount a 10-32 x 5/8" screw onto the rear panel at RB (do not use one of the 10-32 brass nuts). After you tighten the hardware, slide two #10 flat washers onto the end of the screw. Then use a 10-32 wing nut to secure the flat washers. Tighten the wing nut finger tight.

- (✓) Refer to Detail 6-1F and use 6-32 x 1/4" hardware to mount a 2-lug terminal strip onto the inside of the rear panel at RC. Be sure to position the terminal strip as shown in the Pictorial before you tighten the hardware.

() Refer to Detail 6-1G and use the following procedure to mount the barrier strip onto the inside of the rear panel:

- ✓ 1. Refer to Part A of the Detail and prepare a 1-1/8" x 2-1/4" insulator as shown. Discard the leftover insulator paper.
- ✓ 2. Carefully peel away the backing paper from the insulator. Then press the insulator onto the back of the barrier strip in the area shown.
- ✓ 3. Refer to Part B of the Detail and use 6-32 x 1/2" hardware to mount the barrier strip onto the chassis at RD. Do not overtighten this hardware or you could break the barrier strip.
- ✓ 4. Refer again to Part B of the Detail and temporarily remove the five screws from the right side of the barrier strip. Then use the screws to mount a #6 solder lug at each of the five locations. Be sure to position each solder lug as shown in the Pictorial before you tighten its screw.
- ✓ F1: Refer to Detail 6-1H and mount a fuseholder to the rear panel at F1. Use a fuseholder washer and fuseholder nut. Be sure to mount the fuseholder so lug 2 is toward the top of the panel.
- ✓ F2: Similarly mount a fuseholder to the rear panel at F2.
- ✓ Carefully bend lug 2 of each fuseholder out away from the fuseholder body so you can connect wires to them later.
- ✓ K2: Refer to Detail 6-1J and use 6-32 x 3/8" hardware to mount the power relay and a 2 lug terminal strip to the rear panel at K2. Be sure to position the relay and the terminal strip as shown in the Pictorial before you tighten the hardware. Also be sure the tab on the relay seats in the corresponding rear panel hole.
- ✓ SW4: Refer to Detail 6-1K and use 6-32 x 1-1/4" hardware and two 5/16" spacers to mount the interlock switch to the rear panel at SW4. Be sure the side of the switch that has two lugs is toward the left as shown.

Refer to Pictorial 6-2 while you perform the following steps.

NOTE: When you install the capacitors in the next two steps, push the leads through the holes in the eyelets of the indicated terminal strip lugs. Then refer to inset drawing #1 and bend the lugs over sharply against the terminal strip to make a good mechanical connection.

- ✓ C33: Cut the leads of a 4700 pF (472) ceramic capacitor to 3/8". Then connect the capacitor from the eyelet of terminal strip RC lug 1 (S-1) to the center eyelet (NS).
- ✓ C32: Cut the leads of a 4700 pF (472) ceramic capacitor to 3/8". Then connect the capacitor from the eyelet of terminal strip RC lug 2 (S-1) to the center eyelet (S-2).
- ✓ Refer to Detail 6-2A and wrap the leads of one 4700 Ω (4.7 kΩ), 7-watt resistor around the leads of another 4700 Ω (4.7 kΩ), 7-watt resistor. Then solder the connection and cut off the indicated leads.

NOTE: Refer to inset drawing #2 when a step directs you to "make a mechanically secure connection."

- ✓ R4A/R4B: Connect the prepared resistor combination between terminal strip RE lugs 1 (NS) and 2 (NS). Make mechanically secure connections.
- ✓ C1: Cut the leads of a .01 μF, 100V ceramic capacitor to 3/8". Then connect the capacitor from phono socket J3 lug 1 (NS) to the nearby solder lug (S-1).
- ✓ C2: Cut the leads of a .01 μF, 100V ceramic capacitor to 3/4". Then pass one lead through phono socket J4 lug 1 (S-2) to control R2 lug 2 (S-1). Connect the other capacitor lead through the nearby solder lug (S-2) to control R2 lug 1 (S-1).
- ✓ C3: Cut the leads of a .01 μF, 100V ceramic capacitor to 3/8". Then connect the capacitor from phono socket J5 lug 1 (NS) to the nearby solder lug (S-1).



- ✓ Cut a 1" length of large bare wire. Then connect the wire from the bottom hole in the solder lug at barrier strip RD lug 1 (S-1) to the bottom hole in the solder lug at lug 2 (S-1). Make mechanically secure connections.
- ✓ Prepare a 4" medium black stranded wire and a 1-1/2" medium black stranded wire.
- ✓ Connect a 4" medium black stranded wire from interlock SW4 lug 3 (S-1) to terminal strip RE lug 2 (NS). Make a mechanically secure connection.
- ✓ Connect a 1-1/2" medium black stranded wire from terminal strip RE lug 1 (NS) to relay K2 lug 5 (S-1). Make a mechanically secure connection.

IMPORTANT: Before you continue, be sure to read "Power Considerations" on Page 60 and determine whether you will operate your Linear Amplifier from a 120 VAC or a 240 VAC power source. Then proceed with the steps in one of the following boxes.

120 VAC WIRING

Refer to Detail 6-2B while you perform the next four steps.

- () Prepare a 1-1/2" medium black stranded wire.
- () Connect the 1-1/2" medium black stranded wire between terminal strip RE lugs 1 (S-3) and 2 (S-3). Make mechanically secure connections.
- () Prepare two 2" large black stranded wires. Remove 3/8" of insulation from both ends of each wire.
- () Form a hook in each end of a 2" large black stranded wire. Then connect the wire between screws 2 and 3 of barrier strip RD.
- () Form a hook in each end of a 2" large black stranded wire. Then connect the wire between screws 4 and 5 of barrier strip RD.

- () Refer to inset drawing #3 on the Pictorial and use a fuseholder cap to install a 15-ampere fuse in each of the fuseholders at F1 and F2.
- () Carefully peel away the backing paper from the blue and white label. Then refer to Detail 6-2C and press the label onto the rear panel so it covers up the 240 VAC lettering on the rear panel.

240 VAC WIRING

Refer to Detail 6-2D while you perform the next three steps.

- ✓ Solder the wires at terminal strip RE lugs 1 (S-2) and 2 (S-2).
- ✓ Prepare a 2" large black stranded wire. Remove 3/8" of insulation from each end.
- ✓ Form a hook in each end of the 2" large black stranded wire. Then connect the wire between screws 3 and 4 of barrier strip RD.
- ✓ Refer to inset drawing #3 on the Pictorial and use a fuseholder cap to install a 10-ampere fuse in each of the fuseholders at F1 and F2.
- ✓ Carefully peel away the backing paper from the blue and white label. Then refer to Detail 6-2E and press the label onto the rear panel so it covers up the 120 VAC lettering on the rear panel.
- ✓ Replace the line cord plug with the proper plug as described in "Power Considerations" on Page 60.

Refer to Pictorial 6-3 while you perform the following steps.

- ✓ Prepare the end of the line cord as shown in Detail 6-3A. NOTE: The lugs on the end of the line cord will not be needed.

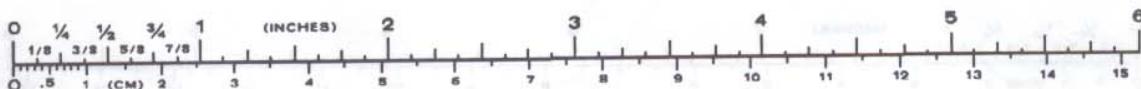

- ✓ Refer to Detail 6-3B and use a strain relief to secure the line cord in rear panel hole RF.
- ✓ Connect the free end of the green line cord wire to solder lug RA (S-1). Make a mechanically secure connection.
- ✓ Connect the free end of the white line cord wire to terminal strip RC lug 1 (NS).
- ✓ Connect the free end of the black line cord wire to terminal strip RC lug 2 (NS).
- ✓ Prepare two 4" large black stranded wires.
- ✓ Connect a 4" large black stranded wire from fuseholder F1 lug 1 (S-1) to terminal strip RC lug 1 (S-2). Make mechanically secure connections. NOTE: A wire was previously soldered in the eyelet of this terminal strip lug.
- ✓ Connect a 4" large black stranded wire from fuseholder F2 lug 1 (S-1) to terminal strip RC lug 2 (S-2). Make mechanically secure connections. NOTE: A wire was previously soldered in the eyelet of this terminal strip lug.
- ✓ Prepare a 4" medium black stranded wire and an 8" large black stranded wire. Then refer to inset drawing #1 on the Pictorial and crimp and solder a push-on connector onto one end of the two wires as shown.
- ✓ Push the push-on connector on one end of the black wires as far as possible onto relay K2 lug 1. Then connect the free end of the 4" medium black wire to interlock SW4 lug 2 (S-1) and the free end of the 8" large black wire to fuseholder F2 lug 2 (S-1). Make mechanically secure connections.
- ✓ Prepare the following lengths of large black stranded wire:
 - 4"
 - 8"
 - 6"
- ✓ Refer to inset drawing #2 on the Pictorial and crimp and solder a push-on connector onto one end of each wire as shown.
- ✓ Push the push-on connector on one end of the 4" large black wire as far as possible onto relay K2 lug

2. Then connect the other end of this wire to the top hole in the solder lug on barrier strip RD lug 1 (S-1). Make a mechanically secure connection. Make sure the wire that was previously soldered to the bottom hole in this solder lug remains well soldered.

- ✓ Push the push-on connector on one end of the 8" large black wire as far as possible onto relay K2 lug 3. Then connect the other end of the wire to fuseholder F1 lug 2 (NS). Make a mechanically secure connection.
- ✓ Push the push-on connector on one end of the 6" large black wire as far as possible onto relay K2 lug 4. Then connect the other end of this wire to the bottom hole in the solder lug on barrier strip RD lug 5 (NS). Make a mechanically secure connection.
- ✓ Prepare the following lengths of wire:
 - 4" small blue solid
 - 26" medium black stranded
 - 26" medium black stranded
 - 16" medium violet stranded
 - 16" medium violet stranded
- ✓ Connect one end of the 4" small blue solid wire to phono socket J3 lug 1 (S-2). The other end of this wire will be connected later.
- ✓ Connect one end of a 26" medium black stranded wire to relay K2 lug 6 (S-1). Make a mechanically secure connection. Route the other end of the wire as shown; it will be connected later.
- ✓ Connect one end of the remaining 26" medium black stranded wire to fuseholder F1 lug 2 (S-2). Make a mechanically secure connection. Route the other end of the wire as shown; it will be connected later.
- ✓ Connect one end of a 16" medium violet stranded wire to the **bottom** hole in the solder lug at barrier strip lug 3 (S-1). Make a mechanically secure connection. Route the other end of the wire as shown; it will be connected later.

NOTE: If you cannot connect the wire to the solder lug, in the next step, wrap the end of the wire around the bare portion of the wire that is already connected to the lug. Then solder the connection.



✓ Connect one end of the remaining 16" medium violet stranded wire to the bottom hole in the solder lug at barrier strip lug 5 (S-2). Make a mechanically secure connection. Route the other end of the wire as shown; it will be connected later.

Refer to Pictorial 6-4 while you perform the following steps.

✓ Refer to the inset drawing on the Pictorial and install cable ties onto the rear panel wires at the three indicated locations.

✓ Check the rear panel assembly for unsoldered connections. The only lug that should not be soldered yet is phono socket J5 lug 1.

Set the rear panel aside until it is called for in a step.

CENTER PANEL

Refer to Pictorial 6-5 while you perform the following steps.

✓ Position the center panel as shown in the Pictorial.

✓ Refer to Detail 6-5A and use 6-32 x 1/4" hardware to mount two #6 solder lugs to the center panel at CA. Be sure to position the solder lugs as shown in the Pictorial before you tighten the hardware.

✓ D3: Refer to Detail 6-5B and use the following procedure to mount the 7.5-volt, 10-watt zener diode to the center panel at D3:

1. Cut open the silicone grease container as shown in the inset drawing. Then apply a thin layer of the grease to both sides of the insulator that is packed with the zener diode. Discard the remaining grease.
2. Line up the hole in the prepared insulator with hole D3 in the center panel. Then position the insulator onto the panel. The grease will hold it in place.
3. Use the hardware supplied with the zener diode to mount it to the center panel. Be sure to position the shoulder washer so

its shoulder enters the panel hole. Also be sure to position the solder lug as shown in the Pictorial before you tighten the hardware.

4. Carefully bend the solder lug away from the panel so you can connect a wire to it later.

5. If you have an ohmmeter available, check the resistance between the diode mounting stud and the center panel. There should be infinitely high resistance.

✓ K1: Refer to Detail 6-5C and use a #6 lock-washer and a 6-32 nut to mount the antenna relay to the center panel. Be sure the locating tab on the relay enters its hole in the panel. Cut the two indicated relay leads from their lugs and prepare the ends, if this has not already been done.

✓ Carefully bend the indicated relay contact as shown in the Pictorial so it does not make contact with the relay's wiper contact. NOTE: This contact is not used in your Amplifier and by bending the lug away from the wiper, you improve the long-term reliability of the other lugs.

✓ B1: Refer to Detail 6-5D and use the following procedure to mount the fan to the center panel:

1. Look at the fan and note that somewhere on the frame are arrows that shown the direction of air flow and the direction of blade movement.
2. If the arrows on your fan are near the terminals, refer to Part A of the detail and use 6-32 x 1/2" hardware to mount the four corners of the fan to the panel. Be sure one of the air flow arrows points toward the panel as shown.
3. If the arrows on your fan are on the curved portion of the frame, refer to Part B of the detail and use 6-32 x 1/2" hardware to mount the four corners to the panel. Be sure the air flow arrows point toward the panel as shown.

Refer to Pictorial 6-6 while you perform the following steps.

✓ Reposition the center panel as shown in the Pictorial.

NOTE: Handle the variable capacitors in the next two steps carefully. Be careful not to bend the plates.

(✓) Refer to Detail 6-6A and use 10-32 brass nuts to mount #10 solder lugs onto the indicated studs of the load variable capacitor at CJ and CK. Be sure to position each solder lug as shown before you tighten the nut. NOTE: This capacitor has more closely-spaced plates than the other variable capacitor.

(✓) C31: Refer again to Detail 6-6A and mount the load variable capacitor to the center panel. Use 6-32 x 5/8" hardware at CD and 6-32 x 3/8" hardware at CE. Tighten the hardware only finger tight at this time.

(✓) Refer to Detail 6-6B and use a 10-32 brass nut to mount a #10 solder lug onto the indicated stud of the plate variable capacitor at CN. Be sure to position the solder lug as shown before you tighten the nut.

(✓) Refer to the inset drawing on Detail 6-6B and use the following procedure to prepare a spade bolt/wire lug combination:

1. Refer to Part 1 and carefully break off the flat portion of a 6-32 spade bolt.
2. Refer to Part 2 and remove the sleeve from a #10 wire lug. NOTE: You may have to use a vise, or something similar to hold the lug while you cut off the sleeve.
3. Push the threaded portion of the spade bolt through the wire lug as shown. Then solder the bolt to the lug.

(✓) Refer again to Detail 6-6B and use a 10-32 brass nut to mount the spade bolt/wire lug combination to the indicated stud of the plate variable capacitor at CR. Be sure to position the lug as shown before you tighten the nut.

(✓) C26: Refer again to Detail 6-6B and turn a 6-32 nut as far as possible onto the end of the 6-32 spade bolt. Then slide a #6 lockwasher onto the bolt and use a 170 pF doorknob capacitor to secure it. Finally, use a 6-32 x 3/16" screw to mount a #6 solder lug onto the doorknob capacitor as shown.

*Done.
10-32
10-32*

(✓) C27: Refer again to Detail 6-6B and use 6-32 x 3/8" hardware to mount the plate variable capacitor and a 4-lug terminal strip to the panel at CB, and only 6-32 x 3/8" hardware at CC. Tighten the hardware only finger tight at this time.

Set the center panel assembly aside until it is called for in a step.

FRONT SUBPANEL

Refer to Pictorial 6-7 while you perform the following steps.

(✓) Position the front subpanel as shown in the Pictorial.

(✓) Position a lamp clip so the end tabs are toward the left as shown at SA in the Pictorial. Then refer to Detail 6-7A and start the longer tabs into subpanel holes SA. Use pliers to bend the tabs toward each other and down against the panel enough to hold the clip in place.

(✓) Similarly install lamp clips at SB, SC, and SD. Be sure the end tabs of each clip are positioned as shown in the Pictorial.

NOTE: Be sure to mount the solder lugs in the next three steps so the bent portion is toward the front subpanel. These solder lugs will be used to hold the meters in place later.

(✓) Refer to Detail 6-7B and use 6-32 x 5/8" hardware and a 5/16" spacer to mount a #6 solder lug to the subpanel at SE. Be sure to position the solder lug as shown in the Pictorial before you tighten the hardware.

(✓) Similarly use 6-32 x 5/8" hardware and a 5/16" spacer to mount a #6 solder lug to the subpanel at SF.

(✓) Refer to Detail 6-7C and use 6-32 x 5/8" hardware and a 5/16" spacer to mount two #6 solder lugs and a 1-lug terminal strip to the subpanel at SG. Be sure to position the solder lugs and the terminal strip as shown in the Pictorial before you tighten the hardware.

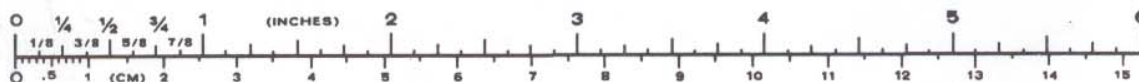

✓ Refer to Detail 6-7D and use 4-40 x 3/8" hardware and a #4 solder lug to mount a vernier drive to the subpanel at SH. Then tighten the hardware only finger tight.

✓ Refer to Detail 6-7E and use 4-40 x 3/8" hardware to mount a vernier drive to the subpanel at SJ. Tighten this hardware only finger tight.

✓ Turn the shaft of the rotary switch on the meter circuit board fully counterclockwise. Then remove the hardware from the switch bushing. Now refer to Detail 6-7F and reinstall the detent ring so its tab is in slot #4. NOTE: Be sure the detent ring tab stays in this position when you perform the next step.

✓ Refer to Detail 6-7G and use the following procedure to mount the meter circuit board to the subpanel at SK:

1. Dress the wires coming from the circuit board as shown.
2. Start the shaft of the rotary switch through subpanel hole SK. Make sure the locating tab on the switch enters its corresponding hole in the subpanel. Also make sure there are no wires pinched between the rotary switch and the subpanel. Then use the large control nut and large control lockwasher you removed from the rotary switch in the previous step to mount the circuit board to the subpanel.

✓ Position the input filter assembly on the subpanel as shown in the Pictorial. Then refer to Detail 6-7H and use four 6-32 x 1/4" screws to secure the assembly to the subpanel.

This completes the assembly of the front subpanel. Set it aside until it is called for in a step.

MAIN CHASSIS

Refer to Pictorial 6-8 while you perform the following steps.

✓ Position the main chassis as shown in the Pictorial (note the locations of the four larger holes where the power transformer will be mounted later).

✓ Refer to Detail 6-8A and use 6-32 x 1/2" hardware and a #6 steel flat washer to mount a foot on the bottom of the main chassis at BA. NOTE: The flat washer is a tight fit on the screw; you may have to thread the washer onto the screw.

✓ Similarly mount feet onto the bottom of the main chassis at BB, BC, and BD.

✓ Refer to Pictorial 6-8B and use 6-32 x 1/4" hardware to mount a 3-lug terminal strip onto the main chassis at BE. Be sure to position the terminal strip as shown in the Pictorial before you tighten the hardware.

✓ Similarly use 6-32 x 1/4" hardware to mount a 4-lug terminal strip onto the main chassis at BF. Position the terminal strip as shown in the Pictorial.

✓ Refer to Detail 6-8C and use 6-32 x 1-1/4" hardware to mount a #6 solder lug onto the main chassis at BG. Be sure to position the solder lug as shown in the Pictorial before you tighten the hardware.

✓ Similarly use 6-32 x 1-1/4" hardware to mount #6 solder lugs onto the main chassis at BH and BJ. Position each solder lug as shown in the Pictorial.

✓ Similarly mount 6-32 x 1-1/4" hardware onto the main chassis at BK. Use a #6 lockwasher in place of a solder lug.

✓ Refer to Detail 6-8D and use the following procedure to mount a tube socket onto the main chassis at V1:

- ✓ 1. Slide a 1/2" spacer onto the end of each screw at BG, BH, BJ, and BK.
- ✓ 2. Slide a #6 fiber flat washer onto the end of each screw at BG, BH, BJ, and BK.
- ✓ 3. Slide the tube socket onto the end of the four screws. Make sure the side of the socket that has two lugs is toward the rear edge of the main chassis as shown.
- ✓ 4. Slide a #6 fiber flat washer onto the end of each screw at BG, BH, BJ, and BK.
- ✓ 5. Use #6 lockwashers and 6-32 nuts to secure the socket. Do not overtighten the nuts.
- ✓ 6. Discard the brackets that were supplied with the tube socket.

✓ C29: Refer to Detail 6-8E and use a 6-32 x 1/4" screw and a #6 lockwasher to mount a 170 pF doorknob capacitor to the main chassis at C29. NOTE: It does not matter which way you mount this capacitor.

✓ C28: Similarly use a 6-32 x 1/4" screw and a #6 lockwasher to mount a 500 pF doorknob capacitor to the main chassis at C28.

✓ Use 6-32 x 3/16" screws to mount #6 solder lugs to the tops of doorknob capacitors C28 and C29. Position the solder lugs as shown in the Pictorial before you tighten the screws.

✓ Refer to Detail 6-8F and use an 8-32 x 1/4" screw to mount a 1" nylon spacer to the main chassis at BL.

✓ Similarly use an 8-32 x 1/4" screw to mount a 1" nylon spacer to the main chassis at BN.

✓ Refer again to Detail 6-8F and use 8-32 x 1/4" screws to mount #8 solder lugs to the tops of the spacers at BL and BN. Position the solder lugs as shown in the Pictorial before you tighten the screws.

Refer to Pictorial 6-9 while you perform the following steps.

✓ C22: Cut both leads of a .01 μF, 500-volt ceramic capacitor to 1/4". Then connect the capacitor between the eyelets of terminal strip BE lugs 1 (S-1) and 2 (NS).

✓ C21: Cut both leads of a .01 μF, 500-volt ceramic capacitor to 1/4". Then connect the capacitor between the eyelets of terminal strip BE lugs 2 (S-2) and 3 (S-1).

✓ Prepare a 7-7/8" medium black stranded wire. Then connect one end of the wire to terminal strip BE lug 1 (NS). The other end will be connected later.

✓ Prepare an 8-3/8" medium black stranded wire. Then connect the wire to terminal strip BE lug 3 (NS). The other end will be connected later.

✓ C23: Cut one lead of a .001 μF (1000 pF), 6000-volt ceramic capacitor to 1". Slide a 3/4" length of sleeving onto this lead. Then connect the end of this lead to terminal strip BE lug 2 (S-1). The other capacitor lead will be connected later. NOTE: Two leads were previously soldered in the eyelet of this terminal strip lug.

✓ C18: Cut both leads of a .01 μF, 500-volt ceramic capacitor to 1/4". Then connect the capacitor between the eyelets of terminal strip BF lugs 3 (S-1) and 4 (NS).

✓ C19: Cut one lead of a .01 μF, 500-volt ceramic capacitor to 1/4" and the other lead to 1-1/8". Slide a 7/8" length of sleeving onto the longer capacitor lead. Then connect the capacitor between the eyelets of terminal strip BF lugs 1 (S-1) and 4 (S-2).

✓ Position capacitors C18 and C19 so they are at least 1/8" away from the chassis. The edge of the rear panel will have to fit between these capacitors and the main chassis when you mount it later.

✓ Prepare a 2" and a 4-1/4" medium black stranded wire. Use these wires in the next two steps.

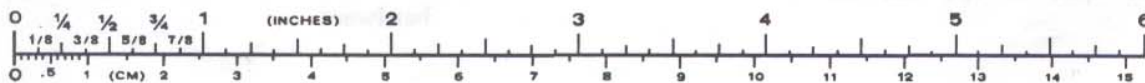

- ✓ Connect the 2" medium black stranded wire from tube socket V1 lug 1 (S-1) to terminal strip BF lug 3 (NS).
- ✓ Connect the 4-1/4" medium black stranded wire from tube socket V1 lug 5 (S-1) to terminal strip BF lug 1 (NS).
- ✓ Cut three 1-1/4" lengths of large bare wire. Use these wires in the next three steps.
- ✓ Connect a 1-1/4" large bare wire from tube socket V1 lug 4 (S-1) to solder lug BG (S-1).
- ✓ Connect a 1-1/4" large bare wire from tube socket V1 lug 3 (S-1) to solder lug BH (S-1).
- ✓ Connect a 1-1/4" large bare wire from tube socket V1 lug 2 (S-1) to solder lug BJ (S-1).
- () RFC2: Use the following procedure to install the filament choke:
 1. Cut all four leads of the choke to 1/2". Scrape any excess enamel from these leads that may prevent you from making a good solder connection. NOTE: It may be necessary to remove some of the insulation from these leads.
 2. Form the leads to fit into the holes in terminal strip BE lugs 1 and 3 and terminal strip BF lugs 1 and 3. You will have to flatten the leads so they can pass through the holes.
 3. Install the choke in the terminal strip lugs as shown. Then solder the leads to the lugs. Also be sure to solder the medium black stranded wire that was previously connected to each lug. Cut off any excess lead lengths.

Refer to Pictorial 6-10 while you perform the following steps.

- ✓ () Position the main chassis as shown in the Pictorial.
- ✓ () Set the center panel onto the main chassis as shown. Make sure the two black stranded wires coming from terminal strip BE pass through the indicated slot in the center panel. Then use three 6-32 x 1/4" screws and three #6

lockwashers to secure the center panel to the main chassis at CF, CG, and CH.

- () Refer to Detail 6-10A and use the following procedure to mount the front subpanel to the main chassis and center panel:
 1. Remove and discard the plastic setscrew retainers from the bushings of the vernier drives.
 2. Set the front subpanel onto the main chassis as shown. Make sure no wires are pinched between the subpanel and the chassis or center panel. Also make sure the shafts of variable capacitors C27 and C31 enter their corresponding holes in the vernier drives.
 3. Use three 6-32 x 1/4" screws and #6 lockwashers to mount the front subpanel to the center panel at SQ, SR, and SS.
 4. Use two 6-32 x 1/4" screws and two #6 lockwashers to mount the front subpanel to the main chassis at ST and SV and a 6-32 x 3/8" screw and a #6 lockwasher at SU.
 5. Turn the shafts of the two vernier drives so the dial pointer mounting screws are parallel to the bottom edge of the front subpanel (refer to inset drawing #1 on the Pictorial). Also make sure at least one of the setscrews in the bushing of each vernier drive is accessible.
 6. Make sure the plates of variable capacitors C27 and C31 are fully meshed (closed).
 7. Push variable capacitors C27 and C31 toward the front subpanel until their shafts are just past the vernier drive setscrews. Then tighten the setscrews against the shafts.
 8. Tighten the vernier drive mounting hardware. Make sure the solder lug on the top vernier drive is toward the top of the front subpanel. Then tighten the hardware that secures variable capacitors C27 and C31 to the center panel. Make sure terminal strip CB is parallel to the top of the center panel as shown in inset drawing #2 on the Pictorial when you tighten its hardware.

✓ () RFC3: Refer to Detail 6-10B and use the following procedure to mount the plate choke to the main chassis:

1. Locate the end of the coil wire at the bottom end of the choke. Then solder the wire to its lug.
2. Locate the end of the coil wire at the top end of the choke. Then solder the wire to its lug.
3. Use a 1/4-20 x 1/2" screw, a small control lockwasher, and a nylon flat washer to mount the choke to the main chassis at RFC3. Be sure to position the choke as shown in the Pictorial before you tighten the hardware. Do not overtighten this hardware.

Refer to Pictorial 6-11 while you perform the following steps.

✓ () Position the main chassis assembly as shown in the Pictorial.

✓ () Connect the free end of the black wire coming from the input filter assembly to the solder lug on the top vernier drive (S-1).

✓ () Route the free end of the shorter coaxial cable coming from the input filter assembly through the cutout in the upper front corner of the center panel assembly. It will be connected later.

✓ () Route the free end of the longer coaxial cable coming from the input filter assembly through the cutout in the upper front corner of the center panel assembly and back through the cutout in the bottom of the center panel. Then route the free end of the cable under filament choke RFC2 and connect the end to terminal strip BF as follows:

✓ () Inner wire to lug 4 (S-1). NOTE: Other leads were previously soldered to the eyelet of this lug.

✓ () Shield wires to lug 2 (S-1).

✓ () Refer to inset drawing #1 on the Pictorial and connect the free end of the large bare wire coming from switch SW1D lug 1 to solder lug CJ (S-1).

✓ () Refer to Detail 6-11A and prepare a 26" length of large coaxial cable as shown.

✓ () Route end B of the prepared coaxial cable through the cutout in the upper front corner of the center panel. This end of the cable will be connected later.

✓ () Route end A of the large coaxial cable along the edge of the front subpanel as shown. Then refer to inset drawing #2 and connect the end of the inner lead to switch SW2D lug 11 (S-3). Wrap the free end of the bare wire coming from switch SW2C lugs 7 around the cable shield. Then solder the wire to the shield.

✓ () Prepare the following lengths of medium bare wire. Use these lengths of wire in the next three steps.

Two 2-3/4"
One 2-1/4"

✓ () Connect a 2-3/4" medium bare wire from capacitor C29 (S-1) to switch SW2E lugs 4 (both lugs). Solder the wire to both switch lugs.

✓ () Connect a 2-3/4" medium bare wire from capacitor C28 (S-1) to switch SW2E lugs 6 (both lugs). Solder the wire to both switch lugs.

✓ () Connect a 2-1/4" medium bare wire from capacitor C26 (S-1) to switch SW2C lugs 9 (both lugs). Solder the wire to both switch lugs.

✓ () Prepare an 11" length of large red stranded wire.

✓ () Route one end of the prepared large red stranded wire through the cutout in the bottom of the center panel. This end of the wire will be connected later. Connect the other wire end to plate choke RFC3 lug 2 (NS).

✓ () Connect the free lead coming from capacitor C23 to plate choke RFC3 lug 2 (S-2). Cut off any excess lead length.

✓ () C24: Cut both leads of a .001 μ F (1000 pF), 6000-volt ceramic capacitor to 1". Then connect the capacitor from solder lug CN (NS) to plate choke RFC3 lug 1 (NS). Cut off any excess lead lengths.

✓ () C25: Cut both leads of a .001 μ F (1000 pF), 6000-volt ceramic capacitor to 1". Then connect the capacitor from solder lug CN (S-2) to plate choke RFC3 lug 1 (NS). Cut off any excess lead lengths.

- ✓ () Position capacitors C24 and C25 away from the frame of the nearby variable capacitor.

Refer to Pictorial 6-12 while you perform the following steps.

- () Locate the 160 & 80 meter tank coil. Then Refer to Detail 6-12A and use the following procedure to prepare the coil:

- ✓ 1. Position the coil as shown in Part A of the Detail. Note the way the leads extend from the coil.
- ✓ 2. Use a 1/4" screwdriver blade to carefully push down the second winding turn from each end of the coil.
- ✓ 3. Reposition the coil as shown in Part B of the Detail so the two turns you pushed down in step 2 are down. Again note the way the leads extend from the coil.
- ✓ 4. Use a felt-tip marker to mark the 18th and 20th turn from end **A** of the coil. When you have the correct turns marked, you should have 24 turns between the 20th turn and end **B** of the coil.
- ✓ 5. When you have the 18th and 20th turns correctly marked, use a screwdriver blade to push these turns down.
- ✓ 6. Shorten the lead at end **A** of the coil to 2-3/8" and the lead at end **B** to 2-3/4".

- () L8: Use the following procedure to install the prepared coil in the main chassis:

- ✓ 1. Set the coil on top of spacers BL and BN as shown. Note the way the leads extend from the coil. Then bend the solder lugs at BL and BN around the indicated coil windings and solder them to the windings. NOTE: Raise each end of the coil while you form the solder lugs.
- ✓ 2. Connect the lead at the right-hand end of the coil to solder lug CK (S-1). Route the wire so it does not touch other 160 & 80 meter coil windings or the plate choke.
- ✓ 3. Route the lead at the left-hand end as shown and form the end of the lead so it is

against the solder lug at switch SW2E lugs 11 (NS). This lead will be soldered later.

- ✓ () Cut a 4" length of large bare wire. Use this wire in the next step.

- ✓ () Connect a 4" large bare wire from the 19th turn of coil L8 (S-1) to switch SW2E lugs 12 (both lugs). Solder the wire to the lugs. NOTE: You will have to flatten the end of the wire so it can pass through the holes in the lugs.

Refer to Pictorial 6-13 while you perform the following steps.

- ✓ () Locate the 40, 20, 15, & 10 meter tank coil. Then refer to Detail 6-13A and use the following procedure to prepare the coil:

- ✓ 1. Position the coil as shown. Note the locations of the three taps and the mounting lug on one end.
- ✓ 2. Grasp the coil near tap #1 with one hand. Then use the other hand to carefully stretch the remaining turns of the coil until the end-to-end length is 4" as shown. NOTE: Stretch the coil so the turns are fairly equally spaced.

- () L7: Refer to Detail 6-13B and use the following procedure to install the prepared coil in the main chassis:

- ✓ 1. Use a 10-32 brass nut to mount the coil to variable capacitor C27 at CP. Tighten the nut only finger tight at this time.
- ✓ 2. Insert the wire at the free end of the coil 1/8" through the solder lug at switch SW2E lugs 11. Do not solder the wire to the lug yet.
- ✓ 3. Position the coil so it is parallel to the chassis and coil L8. Then tighten the brass nut at CP.
- ✓ 4. Solder the other end of the coil to the solder lug at switch SW2E lugs 11. Also make sure you solder the end of the large bare wire coming from coil L8 to the solder lug.

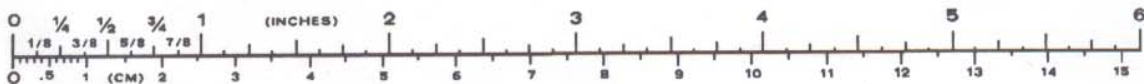

- ✓ Cut the following lengths of large bare wire. Use these wires in the next three steps.

4-1/2"

4-3/4"

3-1/2"

NOTE: When you connect the large bare wires in the following steps, be careful not to exert any excess pressure on the switch lugs. Use long-nose pliers to hold each wire near the switch lugs while you route it.

- ✓ Flatten one end of a 4-1/2" large bare wire. Then connect this end of the wire to switch SW2E lugs 10. Solder the wire to both lugs. Route the free end of the wire as shown and solder it to tap #1 on coil L7.

- ✓ Flatten one end of a 4-3/4" large bare wire. Then connect this end of the wire to switch SW2E lugs 9. Solder the wire to both lugs. Route the free end of the wire as shown and solder it to tap #2 on coil L7.

- ✓ Flatten one end of a 3-1/2" large bare wire. Then connect this end of the wire to switch SW2E lugs 8. Solder the wire to both lugs. Route the free end of the wire as shown and solder it to tap #3 on coil L7.

- ✓ Refer to the inset drawing on the Pictorial and use a screwdriver blade to carefully bend the close-spaced turns of the coil, as necessary, so they do not touch.

- ✓ V1: Unpack the 3-500Z tube. Then match the pins on the bottom of the tube with the holes in its socket and push the tube as far as possible into the socket. CAUTION: Use extreme care when you handle this tube. Gently push the tube into the socket without rocking it. Too much pressure or lateral force (from rocking) may crack the glass beads around the socket pins, and damage the tube. The Heath Company cannot be held responsible for any damage sustained through improper installation.

NOTE: Be careful not to bump or damage the tube while you complete the remainder of the assembly.

- ✓ Refer to Detail 6-13C and use a 6-32 x 1/4" screw to loosely mount a #6 solder lug onto the top of the plate connector as shown.

- ✓ Refer again to Detail 6-13C and start a 6-32 x 1/4" screw in the side of the plate connector. Then push the connector onto the plate cap of tube V1. Now tighten the side screw.

- ✓ Position the solder lug on top of the plate connector toward plate choke RFC3. Then tighten its screw.

- ✓ Cut a 5-1/2" length of large bare wire. Then refer to Detail 6-13D Part A and wrap 3-1/2 turns around the larger portion of the nut starter as shown. Make sure the turns are equally spaced over a length of 7/8". Flex the coil and twist the nut starter to remove it.

- ✓ Refer to Detail 6-13D Part B and solder the prepared coil to the leads of a 100 Ω, 2-watt (brn-blk-brn) resistor.

- ✓ PC1: Connect the prepared resistor/wire combination from plate choke RFC3 lug 1 (S-3) to the solder lug on the plate connector of tube V1 (S-1). Position the choke midway between the plate choke lug and the plate connector. Cut off any excess lead lengths.

Refer to Pictorial 6-14 while you perform the following steps.

- ✓ Reposition the main chassis as shown in the Pictorial.

- ✓ Refer to Detail 6-14A and use six 6-32 x 1/4" screws and six #6 lockwashers to mount the rear panel assembly onto the main chassis as shown. Be careful not to pinch any wires or other parts between the rear panel and the main chassis or the center panel. Also make sure the long black and violet wires coming from the rear panel are on the side of the center panel where the fan is mounted.

- ✓ Route the long medium black stranded wires under the fan, along the bottom edge of the center panel, and out through the indicated opening in the front subpanel. The ends of these wires will be connected later.

Refer to inset drawing #2 on the Pictorial and route the long medium violet stranded wires over the top of the fan and connect them to the fan lugs as follows. You will have to wrap the wires around the lugs. NOTE: The lugs on your fan may be in a different location from that shown in the Pictorial. Shorten these wires as necessary.

- ✓) Either violet wire to fan B1 lug 1 (S-1). Make a mechanically secure connection.
- ✓) Remaining violet wire to fan B1 lug 2 (S-1). Make a mechanically secure connection.
- ✓) Connect the free end of the blue solid wire coming from rear panel socket J3 to relay K1 lug 10 (S-1).
- ✓) Connect the free end of the braided wire coming from relay K1 lug 7 to coaxial socket J2 lug 1 (S-1).
- ✓) Connect the free end of the braided wire coming from relay K1 lug 9 to coaxial socket J1 lug 1 (S-1).
- ✓) Connect the free end of either medium black stranded wire coming through the cutout at the bottom of the center panel to the eyelet of terminal strip CB lug 3 (S-1).
- ✓) Connect the free end of the remaining medium black stranded wire coming through the cutout at the bottom of the center panel to the eyelet of terminal strip CB lug 4 (S-1).

NOTE: Refer to inset drawing #1 on the Pictorial for the relay lug numbering when you connect wires to them in the following steps.

- ✓) Prepare a 7" yellow solid wire. Then connect the wire from relay K1 lug 8 (S-1) to diode D3 lug 2 (S-1).
- ✓) R1: Cut both leads of a 47 k Ω , 1/2-watt (yellow-organ) resistor to 1/2". Then connect the wire from diode D3 lug 1 (NS) to terminal strip CB lug 2 (S-1).
- ✓) Remove all of the insulation from a 1-1/4" length of black solid wire. Then connect the wire from diode D3 lug 1 (S-2) to terminal strip CB lug 1 (NS).
- ✓) Route the free end of the long brown solid wire coming from the meter circuit board as shown. Then connect the end of the wire to relay K1 lug 4 (S-1).
- ✓) Prepare a 24" blue solid wire. Then connect one

end of the wire to relay K1 lug 11 (S-1). Route the free end of the wire as shown and out through the indicated hole in the front subpanel. This end of the wire will be connected later.

Route the free end of the shorter (unconnected) small coaxial cable, coming from the input filter assembly, as shown. Then connect the wires at the end of the cable as follows:

- ✓) Inner wire to relay K1 lug 6 (NS).
- ✓) Shield wires to the upper solder lug at CA (NS).

Route the free end of the large coaxial cable coming from switch SW2D as shown. Then connect the wires at the end of the cable as follows:

- ✓) Inner wire to relay K1 lug 2 (NS).
- ✓) Shield wires to the upper solder lug at CA (S-2).
- ✓) Refer to Detail 6-14B and use 6-32 x 3/8" hardware and a cable clamp to secure the three cables to the center panel at CR.

Refer to Pictorial 6-15 while you perform the following steps.

- ✓) Route the free ends of the longer red and gray wires coming from the meter circuit board as shown.

Position the ALC/power circuit board near the ends of the red and gray wires. Then connect the wires to the circuit board as follows:

- ✓) Red wire to hole D (S-1).
- ✓) Gray wire to hole E (S-1).
- ✓) Refer to Detail 6-15A and use 6-32 x 5/8" hardware and a 5/16" spacer to mount the ALC/power circuit board to the center panel as shown. Be sure to position the circuit board as shown in the Pictorial before you tighten the hardware.

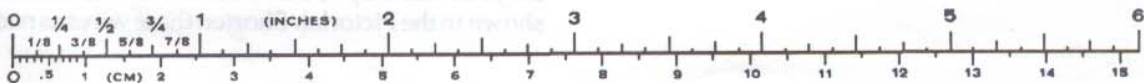

- ✓ Connect the free end of the orange wire coming from the ALC/power circuit board to relay K1 lug 2 (S-2).
- ✓ Connect the free end of the ~~gray~~ ^{red/orange stripe.} wire coming from the ALC/power circuit board to control R2 lug 3 (S-1).
- ✓ Connect the free end of the blue wire coming from the ALC/power circuit board to relay K1 lug 6 (S-2).
- ✓ Cut a 1-1/4" length of medium bare wire. Then connect the wire between relay K1 lugs 5 (S-1) and 1 (S-1).
- ✓ C4: Cut both leads of a 27 pF ceramic capacitor to 3/4". Then connect the capacitor from the center of the large bare wire that is connected between relay lugs 5 and 1 (S-1) to the bottom solder lug at CA (S-1).
- ✓ Route the free end of the long orange wire coming from the meter circuit board as shown. Then connect the end of the wire to socket J5 lug 1 (S-2).
- ✓ Connect either single yellow wire coming from the meter circuit board to the eyelet of terminal strip SG lug 1 (S-1).
- ✓ Route the remaining single yellow wire coming from the meter circuit board out through the indicated opening in the front subpanel. It will be connected later.
- ✓ Route the two twisted pairs of wires out through the indicated opening in the front subpanel. They will be connected later.

NOTE: When you install the lamps in their clips in the following steps, be sure to position each lamp as shown in the Pictorial.

- ✓ PL1: Push a lamp into the lamp clip at SA. Then connect one lead to terminal strip SG lug 1 (NS) and the other lead to the eyelet in its mounting foot (NS).
- ✓ PL2: Shorten both leads of a lamp to 4" and prepare the ends. Push the lamp into the lamp clip at SB. Then connect one lead to terminal strip SG lug 1 (NS) and the other lead to the eyelet in its mounting foot (NS).

- ✓ PL3: Similarly shorten both leads of a lamp to 4" and prepare the ends. Push the lamp into the lamp clip at SC. Then connect one lead to terminal strip SG lug 1 (NS) and the other lead to the eyelet in its mounting foot (NS).

- ✓ PL4: Push a lamp into the lamp clip at SD (do not shorten the leads). Then connect one lead to terminal strip SG lug 1 (S-4) and the other lead to the eyelet in its mounting foot (S-4).

Refer to Pictorial 6-16 while you perform the following steps.

- ✓ Refer to Detail 6-16A and use a cable clamp, #6 lockwasher, and 6-32 nut to secure all of the wires and cables to the center panel at CD. NOTE: Include the large red wire coming through the cutout in the bottom of the center panel. The free end of this wire will be connected later.

- ✓ Similarly, use a cable clamp, #6 lockwasher, and 6-32 nut to secure all of the wires and cables to the main chassis at SU.

- ✓ Dress all of the wires and cables inside the chassis as neatly as possible. Then install cable ties around all of the wires and cables in the six locations shown on the Pictorial. Cut off the excess cable ties.

Refer to Pictorial 6-17 while you perform the following steps.

- ✓ Refer to Detail 6-17A and use 6-32 x 1/4" screws and #6 lockwashers to mount five 4-1/2" tapped spacers to the main chassis at BT, BU, BV, BW, and BX.

- ✓ Refer to Detail 6-17B and use a 6-32 x 1/4" screw and a #6 solder lug to mount a 4-1/2" tapped spacer to the main chassis at BY. Be sure to position the solder lug as shown in the Pictorial before you tighten the hardware.

- ✓ Connect the free end of the black wire coming from the meter circuit board to solder lug BY (S-1).

- ✓ Set the filter circuit board into the chassis as shown in the Pictorial (note the location of

hole A). Then use two 6-32 x 1/4" screws and two #6 lockwashers to mount the indicated corners of the circuit board to spacers BX and BY.

- (✓) Route the free end of the blue wire coming from the meter circuit board as shown. Then connect the end of the wire to filter circuit board hole B (S-1). Cut off any excess wire end.
- (✓) Route the free end of the red wire coming from the meter circuit board as shown. Then connect the end of the wire to filter circuit board hole A (S-1). Cut off any excess wire end.
- (✓) Use a cable tie to secure the blue and red wires to spacer BY. Cut off the excess cable tie.
- (✓) Connect the free end of the large red wire coming from cable clamp CD to circuit board hole E (S-1).
- (✓) Cut both red power transformer leads to 6" and both yellow power transformer leads to 9". Then remove 1/4" of insulation from the end of each of these leads.
- (✓) T1: Set the power transformer in the main chassis as shown. Then refer to Detail 6-17C and use 1/4" x 1" hardware to secure it to the chassis. NOTE: To start each nut onto its screw, you may wish to push the smaller end of the nut starter into the nut as shown in the inset drawing.

NOTE: Make mechanically secure connections when you connect the power transformer leads in the following steps.

- (✓) Connect the green-yellow power transformer lead to terminal strip CB lug 1 (S-2).
- (✓) Connect either green power transformer lead to terminal strip CB lug 3 (S-1). NOTE: A black wire was previously soldered to the eyelet of this lug.
- (✓) Connect the remaining green power transformer lead to terminal strip CB lug 4 (S-1). NOTE: A black wire was previously soldered to the eyelet of this lug.

NOTE: When you solder one of the red wires power transformer leads to filter circuit board hole D, in the next step, be careful not to burn the insulation on the nearby black wire.

- (✓) Loosely twist together (approximately 1 turn-per-inch) the two red power transformer leads. Then connect the end of either lead to filter circuit board hole D (S-1). The other red power transformer lead will be connected later.

Position the rectifier circuit board near the filter circuit board. Then connect the wires coming from the rectifier circuit board as follows:

- (✓) Red wire to filter circuit board hole F (S-1).
- (✓) Black wire to filter circuit board hole C (S-1).
- (✓) Refer to Detail 6-17D and use four 6-32 x 1-1/4" screws, four 3/4" spacers, and four #6 lockwashers to mount the rectifier circuit board and filter circuit board to spacers BT, BU, BV, and BW.
- (✓) Connect the end of the remaining red power transformer lead to rectifier circuit board pin B (S-1).
- (✓) Loosely twist together the two yellow power transformer leads. Then connect either lead to meter circuit board hole A (S-1) and the other lead to hole B (S-1).
- (✓) Connect the free end of the black-white power transformer lead to barrier strip RD lug 5 (S-1). NOTE: Two other wires were previously soldered to the other hole in this lug.
- (✓) Connect the free end of the brown-white power transformer lead to barrier strip RD lug 4 (S-1).
- (✓) Connect the free end of the black power transformer lead to barrier strip RD lug 3 (S-1). NOTE: A wire was previously soldered to the other hole in this lug.
- (✓) Connect the free end of the brown power transformer lead to barrier strip RD lug 2 (S-1). NOTE: A wire was previously soldered to the other hole in this lug.

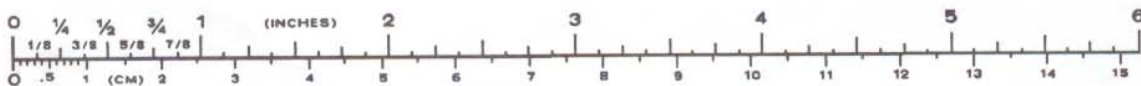

Refer to Pictorial 6-18 while you perform the following steps.

- (✓) Position the front panel as shown in the Pictorial.
- (✓) SW2: Refer to Detail 6-18A and push a rocker switch into front panel hole SW2 until it locks into place. NOTE: Make sure the two lugs are toward the bottom edge of the panel as shown in the Pictorial.
- (✓) SW1: Similarly, push a rocker switch into front panel hole SW1 until it locks into place. NOTE: Make sure the two lugs are toward the bottom edge of the panel as shown in the Pictorial.
- (✓) Locate the LED (light-emitting diode). Then cut the shorter lead to 3/4" and the longer lead to 7/8".
- (✓) D1: Refer to Detail 6-18B and use the following procedure to mount the LED to the front panel:
 1. Push the LED grommet into front panel hole D1.
 2. Hold the LED grommet in place while you push the LED as far as possible into the grommet. NOTE: You may have to wiggle the LED to get its flange started into the grommet.
 3. Push the LED retainer onto the grommet until it locks the LED assembly in place.

Refer to Pictorial 6-19 while you perform the following steps.

- (✓) Position the front panel assembly near the chassis as shown in the Pictorial.
- (✓) Connect the free end of either medium black stranded wire, coming through the hole in the front subpanel, to switch SW3 lug 1 (S-1). Make a mechanically secure connection.
- (✓) Connect the free end of the remaining medium black stranded wire to switch SW3 lug 2 (S-1). Make a mechanically secure connection.

- (✓) Connect the free end of the yellow solid wire to switch SW1 lug 1 (S-1).
- (✓) R3: Cut one lead of a 33 Ω, 1/2-watt (org-org-blk) resistor to 3/8". Then bend the other lead over as shown in Detail 6-19A Part A and cut it so it is the same length as the other lead.
- (✓) Prepare a 3-1/2" yellow solid wire. Then refer to Detail 6-19A Part B and crimp and solder one end of the wire to the indicated resistor lead. Keep the connection as close to the resistor body as possible.
- (✓) Refer again to Detail 6-19A Part B and install a spring connector on the end of each resistor lead.
- (✓) Position the spring connectors and the 2-hole socket shell as shown in Detail 6-19A Part C. Then push the connectors into the socket shell until they lock into place.
- (✓) Push the 2-hole socket shell onto the leads of LED D1 so the resistor lead that does not have the yellow wire soldered to it is connected to the shorter LED lead. Then refer to Detail 6-19A Part D and bend the LED leads over against the socket shell so it cannot slide off of the leads.
- (✓) Connect the free end of the yellow wire to switch SW1 lug 2 (S-1).
- (✓) Connect the free end of the blue wire coming from the cutout in the front subpanel to the indicated lead of resistor R3 (S-1).

Refer to Pictorial 6-20 while you perform the following steps.

- (✓) Carefully peel the backing paper from a light diffuser strip. Then refer to Detail 6-20A and press the light diffuser onto the top of the multimeter.
- (✓) Similarly press a light diffuser onto the top of the grid current meter.
- (✓) M2: Position the face of the multimeter in its corresponding cutout in the front panel.



- ✓ () M1: Similarly, position the face of the grid current meter in its corresponding cutout in the front panel.
- ✓ () Hold the two meters in place while you raise the front panel up toward the front subpanel as shown in Detail 6-20B. Then use two long rails, two short rails, and eight 6-32 x 3/8" screws to mount the front panel to the front subpanel. NOTE: The rails may be mounted either way.

Refer to Pictorial 6-21 while you perform the following steps.

- ✓ () Inspect each meter for a shorting wire that may be connected between the two terminals. Remove any shorting wire that you may find.

Locate the free end of the orange and yellow twisted pair coming from the meter circuit board. Then refer to Detail 6-21A and connect the wires at the free end of this pair to grid current meter M1 as follows:

- ✓ () Orange wire to the positive (+) marked terminal (S-1).
- ✓ () Yellow wire to the negative (-) marked terminal (S-1).

Similarly refer to Detail 6-21A and connect the free end of the red and brown twisted pair coming from the meter circuit board to multimeter M2 as follows:

- ✓ () Red wire to the positive (+) marked terminal (S-1).
- ✓ () Brown wire to the negative (-) marked terminal (S-1).
- ✓ () Carefully peel the backing paper from the Danger label. Then press the label onto the top of power transformer T1 as shown.
- ✓ () Date and sign the FCC label. Then remove the backing paper and press the label onto the outside of the rear panel in the area shown.

Refer to Pictorial 6-22 while you perform the following steps.

- ✓ () Refer to Detail 6-22A and start a 6-32 x 1/8" setscrew into the small knob and two 6-32 x 3/16" setscrews into each of the large knobs. Be sure to start the setscrews into the indicated holes of the large knobs.

- () Turn the shaft of the Multimeter switch fully counterclockwise. Then install the small knob on the shaft of the switch and tighten the setscrew. Be sure to line up the knob pointer with the line at "High Voltage" before you tighten the setscrew. NOTE: The setscrew in the knob does not line up with the flat on the shaft.

- ✓ () Remove both screws from the flange of the top vernier drive. Discard one of the screws. Make sure variable capacitor C27 is fully meshed (closed). Then refer to Detail 6-22B and use one of the screws that you removed from the vernier drive and a #4 fiber flat washer to mount the dial pointer onto the drive as shown. Make sure the pointer is toward the left end of the scale on the front panel. Also make sure the pointer does not rub against the panel.

- ✓ () Similarly mount a dial pointer onto the bottom vernier drive. Make sure variable capacitor C31 is fully meshed and the pointer is toward the "0" on the front panel. Also make sure the pointer does not rub against the panel.

- ✓ () Install a large knob onto the shaft of each vernier drive and tighten the setscrews. Make sure the knob does not rub against the dial pointer.

- ✓ () Turn the shaft of the Band switch fully counterclockwise. Then install a large knob on the shaft of the switch. Make sure the knob pointer lines up with the line at "160" on the front panel before you tighten the setscrews.

INITIAL TESTS AND ALIGNMENT

INITIAL TESTS

In the following steps, you will perform certain tests to verify that your Linear Amplifier is wired properly. If you do not obtain the correct results in any of the steps, check the items listed in some of the steps or refer to the "Troubleshooting Chart" beginning on Page 66. Correct the problem before you continue.

CAUTION: Do not connect the line cord to an AC outlet until astep directs you to do so.

PRIMARY WIRING

Refer to Pictorial 7-1 for the locations of the test points called out in the following steps.

IMPORTANT: A wiring error in the primary wiring circuit (line cord, power switch, etc.) of your kit could cause you to receive a severe electrical shock. These "Primary Wiring Tests" will help you eliminate any such errors that may exist.

- ✓ Be sure the line cord plug is NOT connected to an AC outlet.

NOTES:

1. If you do not have an ohmmeter, carefully check the line cord, switches SW3 and SW4, relay K2, and the power transformer wiring against that shown in Pictorials 6-

2, 6-3, and 6-17 (Illustration Booklet, Pages 20, 22, and 50). Make sure there are no fine strands of wire or solder globs touching adjacent terminals or the chassis.

2. If you have an ohmmeter, perform the following resistance measurements.

- ✓ Set the ohmmeter to the R x 10 range.
- ✓ Connect the negative ohmmeter lead to the ground post on the rear of the chassis. Leave this lead connected to the ground post until a step directs you to disconnect it.
- ✓ Touch the positive ohmmeter lead to either flat prong of the line cord plug. The ohmmeter should indicate infinity with the PWR/OFF switch on or off. If you do not obtain the correct indication, check the wiring of switches SW3 and SW4, relay K2, and barrier strip RD.
- ✓ Touch the positive ohmmeter lead to the other flat prong of the line cord plug. The ohmmeter should indicate infinity with the PWR/OFF switch on or off. If you do not obtain the correct indication, check the wiring of switches SW3 and SW4, relay K2, and barrier strip RD.
- ✓ Touch the positive ohmmeter lead to the round prong of the line cord plug. The ohmmeter should indicate zero ohms with the PWR/OFF switch on or off. If you do not obtain the correct indication, make sure the green line cord lead is properly connected and soldered to solder lug RA.

- ✓ Disconnect the negative ohmmeter lead from the ground post and connect it to either flat prong of the line cord plug.
- ✓ Connect the positive ohmmeter lead to the other flat prong of the line cord plug. The ohmmeter should indicate infinity with the PWR/OFF switch on or off. If you do not obtain the correct indication, check the wiring of switches SW3 and SW4, relay K2, and barrier strip RD. NOTE: Due to the way the safety interlock is designed, the ohmmeter will read infinity with the PWR/OFF switch on.
- ✓ Disconnect the ohmmeter leads from the line cord plug.

SECONDARY WIRING

Refer to Pictorial 7-2 while you make the following tests.

- ✓ Connect the negative ohmmeter lead to the ground post on the rear of the chassis. Leave this lead connected to the ground post until a step directs you to disconnect it.
- ✓ Set the ohmmeter to the R x 10 k range.
- ✓ Touch the positive ohmmeter lead to plate choke RFC3 lug 1. The ohmmeter should indicate 200 k Ω or higher. NOTE: It may take several seconds for the ohmmeter to reach the indicated reading. This is due to the charging effect of some of the capacitors in the circuit.
- ✓ Set the ohmmeter to the R x 10 range.
- 90 ✓ Touch the positive ohmmeter lead to solder lug CN. The ohmmeter should indicate between 80 and 120 ohms.
- ✓ Touch the positive ohmmeter lead to socket J1 lug 1. The ohmmeter should indicate infinity.
- 90 ✓ Touch the positive ohmmeter lead to socket J2 lug 1. The ohmmeter should indicate infinity. Now use your finger to push in on the armature of relay K1. The ohmmeter should indicate between 80 and 120 ohms.
- ✓ Set the ohmmeter to the R x 1 range.

- 12.2
- ✓ Touch the positive ohmmeter lead to the top lead of bridge rectifier D201 on the meter circuit board. The ohmmeter should indicate 20 Ω or higher.
 - ✓ Disconnect the ohmmeter leads from the Amplifier.

POWER ON

Refer to Pictorial 7-3 while you perform the following steps.

NOTE: If you wired your Amplifier for operation from a 120-volt AC source, make sure that the AC outlet you use has adequate wiring to handle the large amount of current that is drawn by the Amplifier.

- ✓ Set the top cover on the chassis as shown. Do not remove the cover from the chassis until a step directs you to do so.

CAUTION: Even though the Amplifier has a safety interlock, there is still a potential danger when the line cord is unplugged and the cover is removed. This is due to the charge that remains on the power supply filter capacitors for several minutes after power is removed.

- ✓ Push the PWR/OFF switch to OFF.
- ✓ Push the OPR/STBY switch to STBY.
- ✓ Turn the MULTIMETER switch to HIGH VOLTAGE.
- ✓ Plug the line cord plug into a proper AC outlet. Make sure the outlet matches the voltage you have the Amplifier wired for (120 VAC or 240 VAC, nominal).

NOTE: If you do not obtain the proper results in the following steps, immediately push the PWR/OFF switch to OFF and unplug the line cord. Correct the problem before you continue.

- ✓ Push the PWR/OFF switch to PWR. The meter lights should light and the fan should run (may be too quiet to hear). In addition, the Multimeter should indicate approximately 3100 volts.

- (✓) Turn the MULTIMETER switch to PLATE CURRENT.
- (✓) Push the OPR/STBY switch to OPR.
- (✓) Plug a shielded cable into the RELAY socket on the rear of the chassis. Then touch the inner conductor at the free end of the cable to the

70

chassis. The Multimeter should indicate between 50 and 80 milliamperes (on the top scale).

- (✓) Push the OPR/STBY switch to STBY.
- (✓) Push the PWR/OFF switch to OFF and unplug the line cord.

ALIGNMENT

Refer to Pictorial 7-4 while you perform the following steps.

- (✓) 1. Preset control R204 on the meter circuit board to 10 o'clock.
- (✓) 2. Connect a wattmeter between your exciter and the RF IN socket of the Amplifier as shown in the Pictorial. NOTE: The wattmeter must be capable of indicating both forward and reflected power.
- (✓) 3. Connect a 50 Ω noninductive dummy load to the RF OUT socket of the Amplifier. Be sure the dummy load can dissipate at least 850 watts.
- (✓) 4. Connect a shielded cable from the RELAY socket on the rear of the Amplifier to your exciter so that the cable is shorted in transmit and open in receive. NOTE: Refer to the "Installation" section for more information about this connection.
- (✓) 5. Reposition the top cover on the chassis so you have access to the coils in the input filter assembly (approximately a 3/4" to 1" gap).
- (✓) 6. Plug the Amplifier line cord into the proper AC outlet.
- (✓) 7. Push the Amplifier POWER switch to ON.
- (✓) 8. Turn on your exciter and allow it to warm up.
- (✓) 9. Set the BAND switches of both your exciter and the Amplifier to 160 meters.
- (✓) 10. Set your exciter for 1.9 MHz. Do not place the exciter in the transmit mode yet.
- (✓) 11. Turn the MULTIMETER switch to POWER OUTPUT.
- (✓) 12. Push the OPR/STBY switch to OPR, if this has not already been done.
- (✓) 13. Preset the PLATE and LOAD controls to the positions indicated in Table 8-1.

Table 8-1

BAND SWITCH	FREQUENCY (in MHz)	PLATE CONTROL	LOAD CONTROL	COIL
160	1.9	160 ↗	2-5 2.5	L1
80	3.85	80 ↑	1-4 0.6	L2
40	7.2	40 ↗ M	3-5 (-1)	L3
20	14.1	20 ↗ M	4-5 2.5	L4
15	21.1	15 ↗ M	6-7 5.3	L5

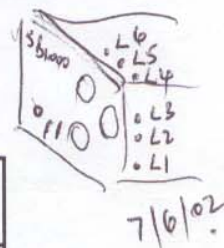

IMPORTANT: This Amplifier is intended for intermittent service only. Do not operate the Amplifier continuously for more than a few seconds at a time.

- ✓ () 14. Set the exciter for minimum output. Then key the exciter.
- ✓ () 15. Increase the drive until you have about 5 to 10 watts of drive on the external wattmeter.
- ✓ () 16. Adjust the PLATE and LOAD controls for maximum indication on the Multimeter.
- ✓ () 17. Use the coil alignment tool to adjust coil L1 for a minimum indication on the wattmeter (set to indicate reflected power).
- ✓ () 18. Increase the drive in 4 or 5 watt increments up to 15 or 20 watts of forward power while you readjust the PLATE and LOAD controls for maximum indication on the Multimeter.
- ✓ () 19. Readjust coil L1 for minimum reflected power on the wattmeter.
- ✓ () 20. Unkey the exciter and set it for minimum output.

- ✓ () 21. Repeat steps 9 through 20 for each position of the BAND switch. NOTE: Table 8-1 shows the frequencies you should use and the approximate settings of the PLATE and LOAD controls.
- ✓ () 22. Connect an accurate wattmeter between the Amplifier's RF OUT socket and the dummy load. Make sure the wattmeter can measure at least 500 watts.
- ✓ () 23. Adjust the exciter and Amplifier for approximately 500 watts of output on the 20-meter band.

CAUTION: Be very careful when you adjust the control on the meter circuit board in the next step. The high voltage filter and rectifier circuit boards are in this area and high voltage is present.

- ✓ () 24. Use the control alignment tool to adjust control R204, on the meter circuit board, until the Multimeter indicates the same power as the external wattmeter.
- ✓ () 25. Unkey the exciter, if this has not already been done. Then turn off the exciter and Amplifier.

This completes the "Initial Tests And Alignment."

Table 8-1 (Cont'd.)

BAND SWITCH	FREQUENCY (in MHz)	PLATE CONTROL	LOAD CONTROL	COIL
160	1.9	160	2-5	L1
80	3.85	80	1-4	L2
40	7.2	40	3-5	L3
20	14.1	20	4-5	L4
15	21.1	15	6-7	L5

FINAL ASSEMBLY

Refer to Pictorial 8-1 while you perform the following step.

- () Set the cabinet top onto the chassis as shown.

Note that the rear sides of the cabinet top have mounting holes. Use fifteen 6-32 x 1/4" screws to secure the cabinet top and sides to the chassis.

INSTALLATION

LOCATION

Do not operate the Amplifier in excessively warm locations or near heating vents or radiators. Be sure air can circulate freely around and through the Amplifier cabinet, and can provide an unobstructed air inlet for the blower. Do not place any books, magazines, or equipment that will impede the free flow of air near the sides of the cabinet.

The internal fan allows an air flow that is greater than 50 CFM. Do not use an external fan with your Amplifier, unless it exceeds this CFM rating by a factor of 2:1.

The exhaust air becomes quite warm at high power levels. Do not position any heat-sensitive objects in the exhaust air stream.

POWER CONSIDERATIONS

Due to the power involved, this Amplifier should have its own 240 VAC electric service line. This line should have three 12-gauge conductors, and 10-ampere fuses in each "hot" wire. If a single 240 VAC line must serve the entire station, however, make an effort to connect your equipment so the load is balanced between the two "hot" wires as nearly as possible.

If you have only 120 VAC available, use a separate line made up of 10-gauge conductors and 20-ampere fuses.

DO NOT use this Amplifier at its full ratings on a regular house wiring circuit, as the ratings of the wire will almost certainly be exceeded.

Avoid excessively long runs of wire between your service entrance and the Amplifier. A heavy flow of current in such a line results in a voltage drop which can affect the performance of your equipment.

The plug on the power cord of your Amplifier is for standard 120 VAC outlets. For 240 VAC operation in the U.S.A., cut off and replace the plug with a permanent plug that matches your 240 VAC receptacle so that your power connection conforms with section 210-21 (b) of the National Electric Code, which reads, in part:

"Receptacles connected to circuits having different voltage, frequencies, or types of current (AC or DC) on the same premises shall be of such design that attachment plugs used on such circuits are not interchangeable."

When you install the new plug, make sure it is connected according to your local electrical code. Keep in mind that the green line cord wire is connected to the Amplifier chassis.

For your convenience in identifying conductors, one conductor is black and the other is white.

120 VAC AND 240 VAC WIRING

The following information is presented in the event you wish to change from 120 to 240 VAC or 240 VAC to 120 VAC at some future time.

Changing from 120 VAC to 240 VAC

Refer to Pictorial 9-1 while you perform the following steps.

- () Unplug the Amplifier's line cord from the AC outlet and remove the top cover. Be sure to allow plenty of time for the high voltage to completely discharge before you proceed. NOTE: You can use the front panel multimeter (in High Voltage position) to check the voltage.
- () Locate the black stranded wire that is connected between terminal strip RE lugs 1 and 2. Then cut off and discard this wire.
- () Remove the two large black stranded wires from barrier strip RD lugs 2 and 3 and lugs 4 and 5.
- () Connect one of the black wires removed in the above step between barrier strip RD lugs 3 and 4.
- () Change fuses F1 and F2 to 10-ampere fuses.

Changing from 240 VAC to 120 VAC

Refer to Pictorial 9-2 while you perform the following steps.

- () Unplug the Amplifier's line cord from the AC outlet and remove the top cover. Be sure to allow plenty of time for the high voltage to completely discharge before you proceed. NOTE: You can use the front panel multimeter (in High Voltage position) to check the voltage.
- () Connect and solder a suitable length of medium black stranded wire between terminal strip RE lugs 1 and 2.

- () Remove the black stranded wire from barrier strip RD lugs 3 and 4.
- () Connect a suitable length of large black stranded wire between barrier strip RD lugs 2 and 3.
- () Connect a suitable length of large black stranded wire between barrier strip RD lugs 4 and 5.
- () Change fuses F1 and F2 to 15-ampere fuses.

ANTENNA

The output circuit of the Amplifier is designed to be connected to an unbalanced transmission line that has a 50-ohm characteristic impedance. Lines of other characteristic impedance may be used, providing the SWR (standing-wave ratio) does not exceed 2:1. In addition, the built-in wattmeter is only accurate at 50 ohms.

The RF OUT connector is a UHF type SO-239. You will need a mating PL-259 plug for your transmission line. Refer to Pictorial 9-3, if necessary, to install this plug.

Use coaxial cables like RG-8/U, RG-11/U, or similar types, for the transmission line. Due to the power level, the smaller types RG-58/U and RG-59/U are not recommended.

The "A.R.R.L. Antenna Book" is readily available and includes comprehensive reference work on transmission lines and antennas. Other similar handbooks for the radio amateur are offered for sale and can often be found in a public library.

GROUNDING

Connect a good earth or water pipe ground to the ground post on the rear panel of the Amplifier. Use the heaviest and shortest connection possible.

Before you use a water pipe ground, inspect the connections around your water meter and make sure that no plastic or rubber hose connections are used. These connections interrupt electrical continuity to the water supply line. Install a jumper around any insulating water connectors you may find. Use heavy copper wire and pipe clamps. It is best to ground all equipment to one point at the operating position and then ground this point as described above.

EQUIPMENT INTERCONNECTIONS

Interconnection between this Amplifier and a typical transceiver is shown in Pictorial 9-4 (Illustration Booklet, Page 64). Many brands of equipment usually follow this same general pattern.

RF IN — Connect this socket to the RF output connector on your transmitter.

RF OUT — Connect this socket to the cable coming from your Antenna.

NOTE: Use shielded cable, such as audio-type cable, for the following connections.

RELAY — Connect this socket to the Relay socket on your transmitter. This connector requires contacts that are normally open in the receive mode and closed in the transmit mode. If your transmitter does not have this switching provision, you will have to

use some other means. If you have separate coaxial transmit-receive relay in your station, it may have external contacts available. You could also use a separate switch. The OPR/STBY switch on the front of the Amplifier must be set to OPR before the Amplifier's internal relay will operate.

NOTE: Some transceivers contain a transistor switch that does not close to a ground potential. If your transceiver is of this type, use an external relay to activate the relay inside the Amplifier.

ALC OUT — Connect this socket to the ALC input of your transmitter. A 0 to 20-volt negative ALC voltage is present at this socket. Refer to your transmitter manual for proper connection information. The ALC ADJ control setting procedure is outlined in the "Operation" section of this Manual.

+12 VDC — Use this socket to power an accessory, such as an "on-the-air" light, etc. Approximately +12 VDC at 100 milliamperes is present at this socket.

GROUNDING

Ground a good earth or water pipe ground to the ground point on the rear panel of the Amplifier. The

connections must be made in a permanent manner. The water supply line should be used if possible. If a water pipe is not available, use a good earth ground. Do not use a gas pipe for a ground. Do not use a ground that is not a permanent connection. Do not use a ground that is not a good earth or water pipe ground.

Remove the two large black standard wire

Connect one of the black wires removed in the

Change pins 1 and 2 to 10-ampere fuse

Change from 120 VAC to 220 VAC

Refer to Pictorial 9-7 while you perform the

Using the Amplifier use cord from the AC outlet and remove the top cover. Be sure to allow plenty of time for the plug voltage to completely discharge before you proceed. **NOTE:** You can use the front panel multimeter in the Voltage position to check the voltage.

Connect and solder a suitable length of medium black standard wire between terminal strip 18 (Fig. 1 and 2).

GENERAL INFORMATION

OPERATION

Refer to Pictorial 10-1 (Illustration Booklet, Page 65) for the locations of the front panel controls and a brief description of each.

READING THE METERS

Refer to Pictorial 10-2 while you read the following information.

MULTIMETER — The MULTIMETER switch on the front of the Amplifier selects the left-hand meter functions. Read the meter scale which corresponds to

the setting of the switch as shown in Table A.

GRID CURRENT meter — The right-hand meter always indicates grid current between 0 and 300 milliamperes. The normal operating range is up to 200 milliamperes. Each division indicates 10 milliamperes.

Table A

MULTIMETER SWITCH POSITION	MEASURES	SCALE INDICATION
HIGH VOLTAGE	Plate voltage	Center scale indicates 0 to 3500 volts (normal operating range is 2700 to 3400 volts). Each division represents 100 volts.
PLATE CURRENT	Plate current	Top meter scale indicates 0 to 700 milliamperes (normal operating range is up to 400 milliamperes, maximum). Each division represents 20 milliamperes.
POWER OUTPUT	Peak RF power	Bottom meter scale indicates 0 to 2000 watts. The scale has 50-watt divisions below 1000 watts and 100-watt divisions above 1000 watts.
ALC	ALC detector	Bottom meter scale indicates 0 to 200 watts. You can estimate the approximate drive level (average, not PEP) by dividing the bottom meter indication by 10. This indication is derived from the voltage at the output of the ALC detector.

GENERAL INFORMATION

SAFETY INTERLOCK

While the Amplifier's top cover is in place, the interlock switch closes to allow AC line voltage to reach the power transformer. When the top cover is removed, the interlock opens and disconnects the line voltage. This does not discharge the bank of power supply filter capacitors. Be sure to allow the filter capacitors to discharge before you touch anything inside the Amplifier. You can select the High Voltage function of the Multimeter to check the high voltage potential.

TUBE

It is not abnormal for the tube to show a dull red color. But if the plate shows a bright orange or yellow color, immediately investigate the tuning and drive conditions and make any necessary corrections.

After prolonged operation, let the Amplifier run for several minutes without excitation so the fan will cool the tubes before you turn the Amplifier off.

DRIVING POWER

This Amplifier is designed to operate at full ratings (refer to "Specifications") when it is driven by an exciter that has approximately 100 watts of RF output. You can use an exciter that has lower output power, but the Amplifier's output will be less. If you use an exciter that delivers more than 100 watts, carefully adjust the driving power to avoid "overdrive" and the creation of spurious signals, which create needless interference to other operators. We highly recommend that you use a monitor scope for continuous output monitoring. The display on an oscilloscope is the best readily available way of determining the amplitude of the voice peaks which, if excessive, can cause "flat-topping" and radiation of distortion products.

IMPORTANT: In no case should you advance the power output control of your exciter beyond the point

where the Amplifier's Power Output indication ceases to increase. If you turn the control past this point, nonlinear operation may occur.

ALC (Automatic Level Control)

Whenever the Amplifier is overdriven, the ALC circuitry creates a negative voltage that is fed back to the exciter to reduce its gain and help prevent "flat-topping."

Protective circuitry of this nature is a valuable circuit element, but it is not a substitute for proper adjustment of the exciter drive.

Setting The ALC ADJ Control

Before the ALC circuitry will function properly, the ALC ADJ control on the rear of the Amplifier must be adjusted to work with your particular exciter. The following steps outline the procedure:

NOTE: The Amplifier must be properly tuned on CW before you adjust the ALC.

1. Set the MULTIMETER switch to POWER OUTPUT.
2. Set the transmitter audio control to approximately 20% higher than normal.
3. Speak into the microphone in a normal tone of voice and observe the indication on the 0 to 2000 RF watts meter scale.
4. Adjust the ALC ADJ control on the rear of the Amplifier until the Amplifier shows no clipping on an RF monitor scope. **NOTE:** If an RF monitor scope is not available, adjust the ALC ADJ control so the audio peaks do not exceed the single tone output of 1000 watts.

AMPLIFIER

The OPR/STBY switch may be used to remove the Amplifier from the RF line while you tune the exciter (the Amplifier is in a bypass mode). It does not, however, switch off the AC or DC power supplies.



TUNE-UP

The current and voltage figures given in this section are approximate. Actual indications will vary at each installation with such factors as line voltage, exciter drive, and load impedance.

The following procedure for tuning the Amplifier should take only a few seconds after you go through it a few times. Note the LOAD control position so you can preset it the next time you use a particular band.

NOTE: If tune-up on the higher frequency bands is broad and the LOAD control is at minimum capacitance, you may be able to improve the tune-up by slightly expanding the section of tank coil L7 that is between tap #3 and point CP (refer back to Pictorial 6-13).

For your convenience, the following chart shows typical settings:

FREQUENCY (in MHz)	BAND	PLATE CONTROL	LOAD CONTROL (typical)
1.85	160	160	2 to 5
3.5	80	80	1 to 4
3.8	80	80	3-1/2
7.2	40	40	3 to 5
14.2	20	20	4 to 5
21.2	15	15	6 to 7

CW PROCEDURE

Make sure you have the Amplifier connected as described in the "Installation" section. **IMPORTANT:** Before you proceed, make sure you have a dummy load (such as the Heathkit Antenna) or an appropriate antenna connected to the Amplifier output.

1. Preset the Amplifier controls as follows:

PWR/OFF ——— Off
 OPR/STBY ——— STBY
 MULTIMETER ——— High Voltage

2. Plug the line cord into a proper AC outlet.
3. Set the PWR/OFF switch to PWR. The meter lamps should light and the fan should run. The 0 to 3500V scale on the multimeter should indicate approximately 3400 volts.
4. While the Amplifier is still in standby, tune the exciter into the normal 50-ohm load according to the manufacturer's instructions. Then, after you have the exciter properly tuned, turn the exciter drive all the way down.

5. Turn the BAND switch to the same band as the exciter. Then preset the PLATE and LOAD controls to the positions indicated in the above chart for the band you have selected.
6. With the exciter drive still at zero, set the MULTIMETER switch to PLATE CURRENT. The 0 to 700 mA scale should indicate zero. Now set the OPR/STBY switch to OPR.
7. Key the exciter (with no drive) and observe the plate current on the 0 to 700 mA scale. The plate current should now indicate 50 to 80 mA.
8. Apply only enough drive to obtain 50 mA of grid current and no more than 200 mA of plate current. Now tune the PLATE control for maximum grid current. Unkey the exciter. NOTE: It is normal for the plate current to dip (be reduced) when you have maximum grid current. If the grid current goes over 100 mA, immediately reduce the drive.
9. Set the MULTIMETER switch to POWER OUTPUT and observe the 0 to 2000 peak RF watts meter scale. Again key the exciter and

adjust the LOAD and PLATE controls for maximum output on the 0 to 2000 scale.

10. Increase the exciter drive until you obtain 125 mA of grid current. Now readjust the LOAD and PLATE controls for maximum output. The grid current should decrease.
11. Increase the exciter drive for 200 mA of grid current. Then readjust the LOAD and PLATE controls for maximum output power (repeat this step twice). The output should now be around 1000 watts with 100 watts of exciter power.
12. Apply only enough drive to indicate either 1000 watts of output power, or 200 mA of grid current. Then repeat the LOAD and PLATE controls. NOTE: The grid current, plate current, and output power must not exceed the following limits:

Grid current	_____	200 mA
Plate current	_____	550 mA
Output power	_____	1000 watts

13. When you operate in CW, reduce the drive power until the plate current is 400 mA or less.

The Amplifier is now fully loaded for operation on CW. If you desire to reduce the Amplifier output power, refer to Pictorial 10-3 for the plate voltage and current indications that will produce various DC power input levels. If you use an oscilloscope for monitoring, you should obtain a display similar to that shown in Pictorial 10-4. If you have a monitor scope, you may find that you can more readily

interpret voice patterns on its optional trapezoid display.

SSB PROCEDURE

1. Tune up the exciter and Amplifier as described for CW operation. NOTE: In the absence of the recommended oscilloscope monitor, either the Plate Current or the Output Power indications may be used to monitor SSB transmissions. The Plate Current indications are easier to follow.
2. Advance the exciter drive and audio levels so that the modulation crest does not exceed 400 mA of plate current, 100 mA grid current, or 1200 watts PEP out-put.

An example of a proper SSB oscilloscope pattern is shown in Pictorial 10-5. Note that there are sharp, distinct peaks. The number of patterns or "christmas trees" depend upon the operator's voice characteristics and the scope sweep speed. Set the scope for approximately 30 Hz sweep.

Note that the meter indication on voice peaks is not high, due to meter inertia and voice characteristics. The height of the oscilloscope pattern, however, is greater than that shown in Pictorial 10-4.

Pictorial 10-6 shows the same voice pattern, but with extreme "flat-topping." The oscilloscope shows that no more useful power is being developed. When the drive level is too high, the meter indicates higher, but only distortion is developed.

PERIODIC MAINTENANCE

Remove the top cover from the Amplifier at least once a year and remove the dust. Dust accumulation can help cause the variable capacitors to arc between plates. Use the blower connection on a vacuum

cleaner or a soft bristle brush. While the top cover is removed, add one drop of light machine oil to each fan bearing.

TROUBLESHOOTING CHART

IN CASE OF DIFFICULTY

NOTE: If you operate the Amplifier outside the specified power or frequency range (or both), components may be damaged. Such damage is not covered by the Heath warranty.

This part of the Manual helps you locate and correct any difficulty that might occur in your Amplifier. This information is divided into two sections. The first section, "General," contains suggestions for reviewing your kit to locate possible causes of incorrect performance.

The second section is a "Troubleshooting Chart." This chart describes specific problems that may occur and lists one or more conditions or components that could cause each difficulty.

NOTE: In an extreme case where you are unable to resolve a difficulty, refer to "Customer Service" inside the rear cover of this Manual. Your Warranty is located inside the front cover.

If it ever becomes necessary to take (or ship) your kit to the Heath Company or to a Heath/Zenith Computers and Electronics Center for repair, be sure it is completely assembled -- including all of the knobs and cabinet parts.

GENERAL

1. Recheck the wiring. Trace each lead in colored pencil on the Pictorial as you check it. It is frequently helpful to have a friend check your work. Someone who is not familiar with the unit may notice something that you have consistently overlooked.

2. Check for bits of solder, wire ends, or other foreign matter which may be lodged in the wiring.
3. About 90% of the kits that are returned for service do not function properly due to poor connections and soldering. You can, therefore, eliminate many troubles by reheating all connections to make sure they are soldered properly, as described in the soldering instructions in this Manual.
4. Make sure the tube lights up properly. If it does not, remove the tube from its socket and check for continuity between pins 1 and 5 with an ohmmeter. An infinite resistance indicates a faulty tube filament.
5. Check the values of the parts. Be sure that the proper part has been wired into the circuit at each location as shown in the Pictorials and as described in the wiring instructions.
6. A review of the Circuit Description may help you locate the area of trouble.

NOTE: Refer to the "Circuit Board X-Ray Views" (Illustration Booklet, Page 67) for the physical locations of parts.

TROUBLESHOOTING CHART (Cont'd)

DIFFICULTY	POSSIBLE CAUSE
No high voltage.	<ol style="list-style-type: none"> 1. Diode D301 through D310. 2. Capacitor C401 through C408. 3. Resistor R405 through R409 or R411 through R413. 4. Coil L401. 5. Choke RFC3. 6. Parasitic choke PC1.
None of the meter lamps light.	<ol style="list-style-type: none"> 1. Lamps PL1 through PL4. 2. Bridge rectifier D201.
Relay K1 does not activate.	<ol style="list-style-type: none"> 1. OPR/STBY switch SW1. 2. Interconnection to exciter. 3. Resistor R3. 4. Relay K1.
Plate control has no effect.	<ol style="list-style-type: none"> 1. Band switch SW2A, B, C, D, or E. 2. Coil L7 or L8. 3. Capacitor C26, C28, or C29. 4. Variable capacitor C27.
No RF output.	<ol style="list-style-type: none"> 1. Relay K1 wired wrong. 2. Coil L7, L8, or L9. 3. Coaxial cable between Band switch and relay K1. 4. Band switch SW2A, B, C, D, or E. 5. Variable capacitor C31.
ALC inoperative.	<ol style="list-style-type: none"> 1. Interconnection to exciter. 2. Setting of control R2.
Amplifier is hard to drive.	<ol style="list-style-type: none"> 1. Cables to input filter chassis are interchanged. 2. Band switch SW2A, B, C, D, or E. 3. Coils L1 through L6.
Plate current does not increase with added drive power.	<ol style="list-style-type: none"> 1. Exciter and Amplifier are set to different bands. 2. Band switch SW2A, B, C, D, or E. 3. Coils L1 through L6.

CIRCUIT DESCRIPTION

Refer to the Schematic (Illustration Booklet, Page 70) while you read the following paragraphs. The component numbers are arranged in the following groups to help you locate specific parts on the Schematic, circuit boards, and chassis:

- 1 — 99 Parts mounted on the chassis.
- 101 — 199 Parts mounted on the ALC/power circuit board.
- 201 — 299 Parts mounted on the meter circuit board.
- 301 — 399 Parts mounted on the rectifier circuit board.
- 401 — 499 Parts mounted on the filter circuit board.

Power Supply

Power transformer T1 supplies the power required to operate the Linear Amplifier. A dual-winding primary allows the Amplifier to be operated from 120 VAC or 240 VAC. These windings are connected in parallel for 120 VAC operation or in series for 240 VAC. Two 10-ampere or two 15-ampere fuses protect the transformer against overload depending upon the primary voltage. Capacitors C32 and C33 are provide AC line bypassing.

This amplifier uses a special combination safety interlock/switch-saver circuit. Interlock switch SW4, PWR switch SW3, relay K2, and paralleled resistors R4A/R4B are connected in series across the AC line. When either Interlock switch SW4 or PWR

switch SW3 are open, no power is applied to relay K2. The contacts of this high-current relay do the actual connection of the AC line voltage to the windings of power transformer T1. Only the current that is drawn by the relay coil passes through the PWR switch.

Relay K2 has a 120 VAC coil. During 120 VAC operation, resistor combination R4A and R4B is shorted out to apply the full line voltage to the relay coil. During 240 VAC operation, however, the resistor combination provides current limiting for the relay coil.

Fan motor B1 is connected across only one of the primary windings so that it always operates on 120 VAC, regardless of which input voltage is used.

HIGH VOLTAGE

The larger of the secondary windings of transformer T1 is connected to a full-wave, voltage doubling circuit formed by the components on the rectifier and filter circuit boards. Diodes D301 through D310 rectify the secondary AC voltage while capacitors C401 through C408 filter this voltage. Capacitors C301 through C309 and C311 are connected across the diodes to protect them against transients. Resistors R405 through R409 and R411 through R413 are connected across the filter capacitors to equalize the voltage drop across each capacitor. These resistors also help discharge the filter capacitors when the Amplifier is turned off.

One of the red power transformer leads is connected to the junction of capacitors C404 and C405. During the half cycle when this lead is positive, capacitors C401 through C404 are charged. During the other half cycle, the other red power transformer lead is positive and capacitors C405 through C408 are charged. These two capacitor strings are in series across the load, and the voltages of each group add together.

Resistors R401 through R404 are discussed under "Metering Circuits."

Choke RFC3 and capacitor C23 keep RF energy out of the power supply circuits.

FILAMENT AND BIAS

In addition to the larger secondary winding just described, power transformer T1 has two smaller secondary windings. One of these windings supplies 5 VAC at 15 amperes for the amplifier tube filaments. The filament voltage is fed to tube V1 through RFC2, which is a bifilar-wound coil on a ferrite core. This coil forms a choke to raise the tube filaments above RF ground so that the driving voltage is not short circuited. Capacitors C21 and C22 keep RF out of the filament supply circuits.

In the transmit mode, the center tap of the filament winding is connected to ground through 7.5-volt zener diode D2, lugs 8 and 4 of relay K1, and resistor R203. The plate current through the zener diode develops the 7.5-volts DC operating bias for tube V1 and limits the idling plate current. In the receive mode, a positive DC voltage is formed across resistor R1. This voltage is applied to the tube filaments, in addition to the AC voltage, to bias the tube grid beyond cutoff so that no plate current flows.

The remaining power transformer secondary winding is fed to a full-wave rectifier circuit on the meter circuit board which supplies the voltage needed to operate relay K1, pilot lamps PL1 through PL4. This voltage also provides 12 VDC (at 100 milliamperes) at rear panel jack J5 for accessories.

Relay

Relay K1 has three sets of single-pole, double-throw contacts. In the receive mode, the relay coil is not energized. Switch SW1 allows you to keep the relay in a standby state. Approximately 12 volts DC is

connected to one side of the relay coil at lug 11. Lug 10 connects the other side of the relay coil to RLY jack J3 on the rear panel. This jack is usually connected to normally-open relay contacts in the exciter (such as a VOX or PTT relay). When these contacts close, they must connect the relay coil circuit to ground (0 VDC). The relay will then close to place the contacts in the transmit mode. NOTE: A transistor switch may not allow relay K1 to operate properly, because this type of switch does not go to zero volts.

The function of relay contacts 4 and 8 were discussed earlier in the "Filament and Bias Supply" section.

Relay contact 9 is connected to RF IN jack J1. In the receive mode, the incoming signal is transferred directly to the RF output through relay contacts 7, 1, 5, and 9. In the transmit mode, the RF input voltage is connected through relay contacts 9 and 6 to the wiper of the Band switch SW2A. The amplified RF output is connected through relay contacts 2 and 7 to RF Out jack J2.

RF Circuits

INPUT

An input impedance-matching pi network circuit for each band is switched into the circuit by Band switch SW2A. After the signal passes through the matching circuit, the RF driving power is coupled through switch SW2B and capacitors C18 and C19 to the tube filaments.

TUBE

The amplifier tube is connected in a class AB 2 grounded grid circuit. RF driving power is applied to the filaments in the normal cathode-driven configuration. As mentioned in the "Power Supply" section, choke RFC2 holds the filaments above RF ground.

Pins 2, 3, and 4 of the tube are internally connected together and are connected directly to ground.

Parasitic choke PC1 is connected into the plate lead to suppress any VHF parasitic oscillations.

The positive side of the power supply is connected to the tube through RFC3.

Fan B1 circulates cooling air around the tube.

OUTPUT

The tuned output circuit of the Amplifier is a pi network consisting of Plate capacitor C27, load capacitor C31, and coils L7, L8, and L9.

Band switch SW2E progressively shorts out the unused portions of coils L7 and L8. The coil turns in use are tuned to resonance by Plate capacitor C27. Load capacitor C31 is tuned to complete the impedance match between the tube and the load that is connected to RF Out jack J2. On the 160-meter band, fixed capacitors C28 and C29 are switched in parallel with Load capacitor C31 to provide the additional capacitance required on this band. On the 80 and 40-meter bands, capacitor C29 is switched in parallel with Load capacitor C31.

If a DC voltage is unintentionally applied to the plate output circuit, RFC1 will provide a DC path to ground, thereby short-circuiting the high voltage supply, which will blow the fuses.

ALC Circuit

Control R2 allows you to set the ALC threshold to match your exciter.

Capacitors C106 and C107 form an RF voltage divider that couples some of the RF driving voltage to diodes D103 and D104. When the RF driving voltage exceeds the ALC threshold voltage, the diodes rectify the negative half cycles. Capacitor C105 filters and bypasses this voltage, while resistor R103 provides isolation.

The negative voltage appearing at ALC jack J4 is coupled back to the exciter to reduce its gain and reduce "flat-topping" of voice peaks due to overdrive.

Metering Circuits

GRID CURRENT METER

Refer to Pictorial 11-1 for a simplified drawing of the grid current meter circuit.

Grid current meter M1 provides an indication of grid current between 0 and 300 milliamperes. The grid current meter is connected in parallel with shunt

resistor R203. The grid circuit return is through relay K1 lugs 4 and 8, zener diode D2, to the center tap of the filament winding of power transformer T1.

MULTIMETER

HV (High Voltage)

Refer to Pictorial 11-2 for a simplified drawing of the high voltage meter circuit.

When you select this function, resistors R401 through R404 form a voltage divider to measure the high voltage. Resistors R402 through R404 form a series multiplier resistance for meter M2, while resistor R401 forms a current shunt for the meter.

IP (Plate Current)

Refer to Pictorial 11-3 for a simplified drawing of the plate current meter circuit.

When you select this function, meter M2 indicates the plate current drawn by the tube between 0 and 700 milliamperes. It is switched in parallel with resistor R202 and measures the voltage drop across it. The meter scale is calibrated to indicate the plate current by using the fixed value of resistor R202 and the voltage across it.

PO (Power Output)

Refer to Pictorial 11-4 for a simplified drawing of the power output meter circuit.

Capacitors C101, C102, and C103 on the ALC/power circuit board form an RF voltage divider for a portion of the RF output voltage to a rectifier circuit formed by diodes D101 and D102. Capacitor C104 provides filtering and bypassing. The resulting DC voltage then passes through resistor R101 to the meter circuit board.

The DC voltage coming from the ALC/power circuit board passes through control R204 to an amplifier circuit formed by transistor Q201 and its associated components. From here, the current passes through multiplier resistor R206 to the multimeter, which is calibrated to indicate peak output power between 0 and 2000 watts. Control R204 allows you to calibrate the meter for this function.

ALC

Refer to Pictorial 11-5 for a simplified drawing of the ALC meter circuit.

When you select this function, a portion of the negative ALC voltage developed on the ALC/power circuit board (described earlier) passes through resistors R103 and R207 to multimeter M2.



RESISTOR	VALUE	WATTAGE	TYPE
R103	100K	1/4W	Carbon Film
R207	100K	1/4W	Carbon Film
R104	100K	1/4W	Carbon Film
R105	100K	1/4W	Carbon Film
R106	100K	1/4W	Carbon Film
R107	100K	1/4W	Carbon Film
R108	100K	1/4W	Carbon Film
R109	100K	1/4W	Carbon Film
R110	100K	1/4W	Carbon Film
R111	100K	1/4W	Carbon Film
R112	100K	1/4W	Carbon Film
R113	100K	1/4W	Carbon Film
R114	100K	1/4W	Carbon Film
R115	100K	1/4W	Carbon Film
R116	100K	1/4W	Carbon Film
R117	100K	1/4W	Carbon Film
R118	100K	1/4W	Carbon Film
R119	100K	1/4W	Carbon Film
R120	100K	1/4W	Carbon Film

When you select this function a portion of the negative A.C. voltage developed on the A.C. power circuit board (described earlier) passes through resistors R10 and R11 to terminals M2.

Refer to Figure 11-5 for a simplified drawing of the A.C. meter circuit.

SEMICONDUCTOR IDENTIFICATION

DIODES

COMPONENT NUMBER	HEATH PART NUMBER	MAY BE REPLACED WITH	KEY NUMBER
D1	412-640	Red LED (light-emitting diode)	A1
D2	230-6794	7.5 V, 10W zener	A2
D101	56-56	1N4149	A2
D102	56-56	1N4149	A2
D103	56-56	1N4149	A2
D104	56-56	1N4149	A2
D201	230-6784	Bridge rectifier	A3
D301	230-6776	1N5408	A2
D302	230-6776	1N5408	A2
D303	230-6776	1N5408	A2
D304	230-6776	1N5408	A2
D305	230-6776	1N5408	A2
D306	230-6776	1N5408	A2
D307	230-6776	1N5408	A2
D308	230-6776	1N5408	A2
D309	230-6776	1N5408	A2
D310	230-6776	1N5408	A2
D401	230-6776	1N5408	A2

IDENTIFICATION

A1

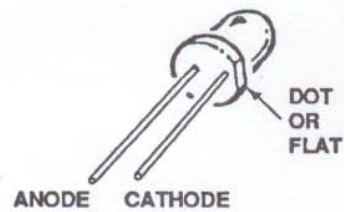

A2

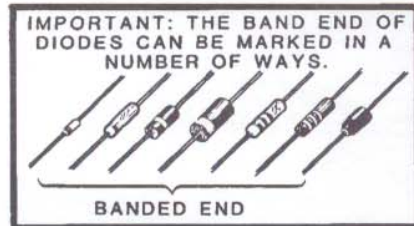

A3

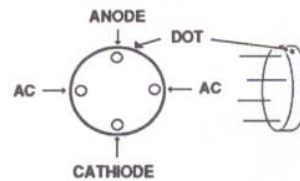

TRANSISTOR

<u>COMPONENT NUMBER</u>	<u>HEATH PART NUMBER</u>	<u>MAY BE REPLACED WITH</u>	<u>KEY NUMBER</u>
Q1	417-875	2N3904	B1

VACUUM TUBE

<u>COMPONENT NUMBER</u>	<u>HEATH PART NUMBER</u>	<u>MAY BE REPLACED WITH</u>	<u>KEY NUMBER</u>
V1	411-245	3-500Z	C1

IDENTIFICATION

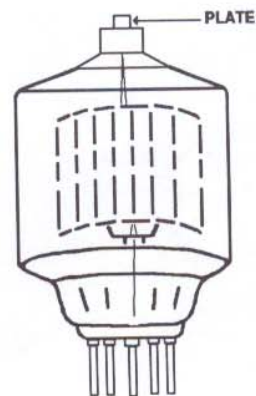
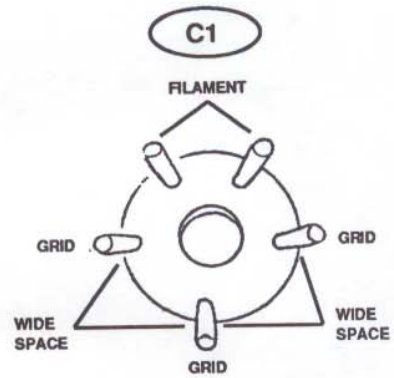
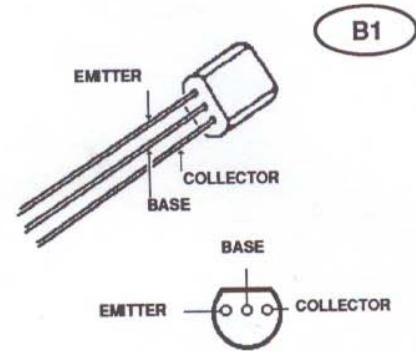

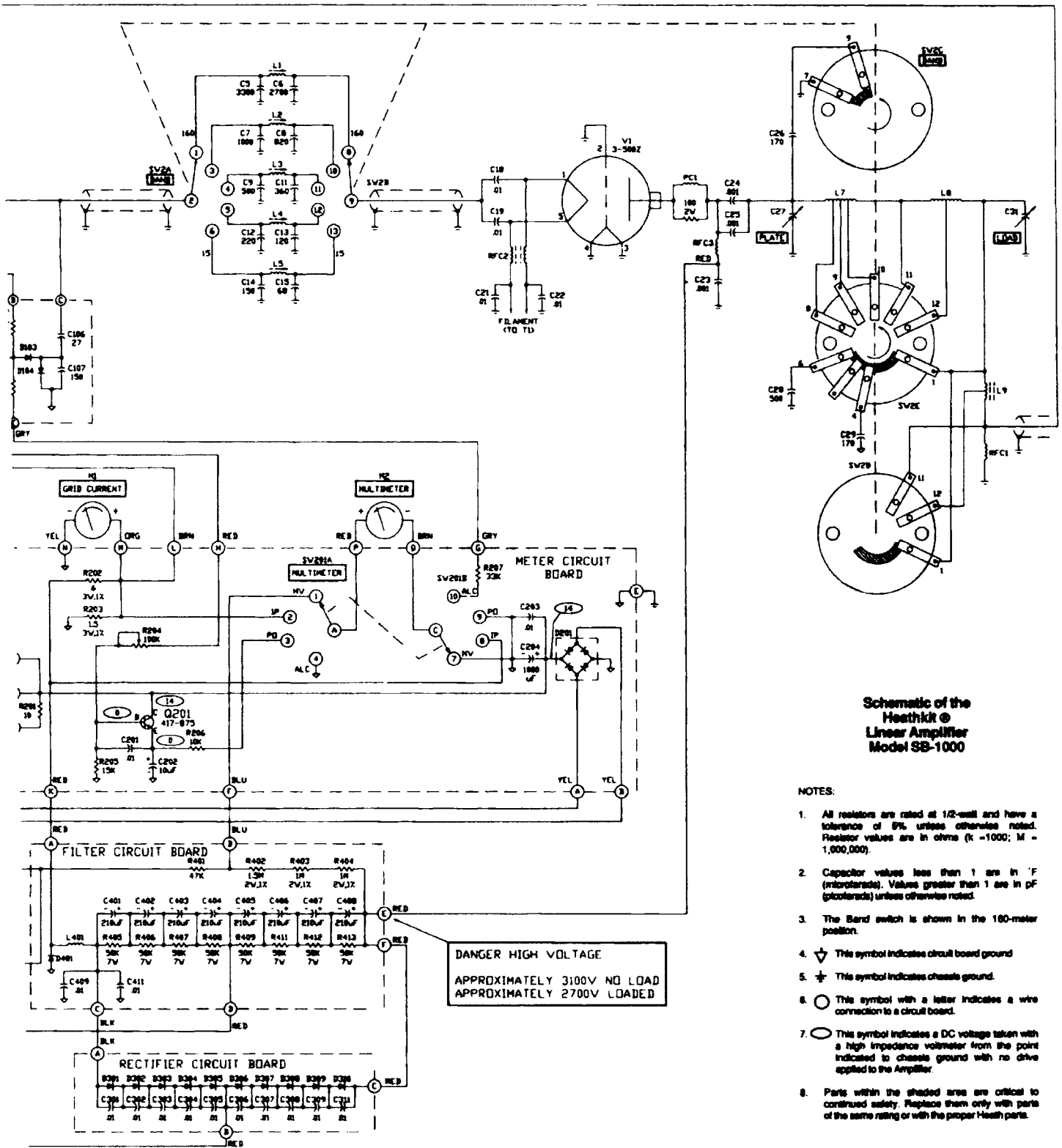

**Schematic of the
Heathkit®
Linear Amplifier
Model SB-1000**

NOTES:

1. All resistors are rated at 1/2-watt and have a tolerance of 5% unless otherwise noted. Resistor values are in ohms (k = 1000; M = 1,000,000).
2. Capacitor values less than 1 are in μ F (microfarads). Values greater than 1 are in pF (picofarads) unless otherwise noted.
3. The Band switch is shown in the 180-meter position.
4. ∇ This symbol indicates circuit board ground.
5. \star This symbol indicates chassis ground.
6. \bigcirc This symbol with a letter indicates a wire connection to a circuit board.
7. \bigcirc This symbol indicates a DC voltage taken with a high impedance voltmeter from the point indicated to chassis ground with no drive applied to the Amplifier.
8. Parts within the shaded area are critical to continued safety. Replace them only with parts of the same rating or with the proper Heath parts.

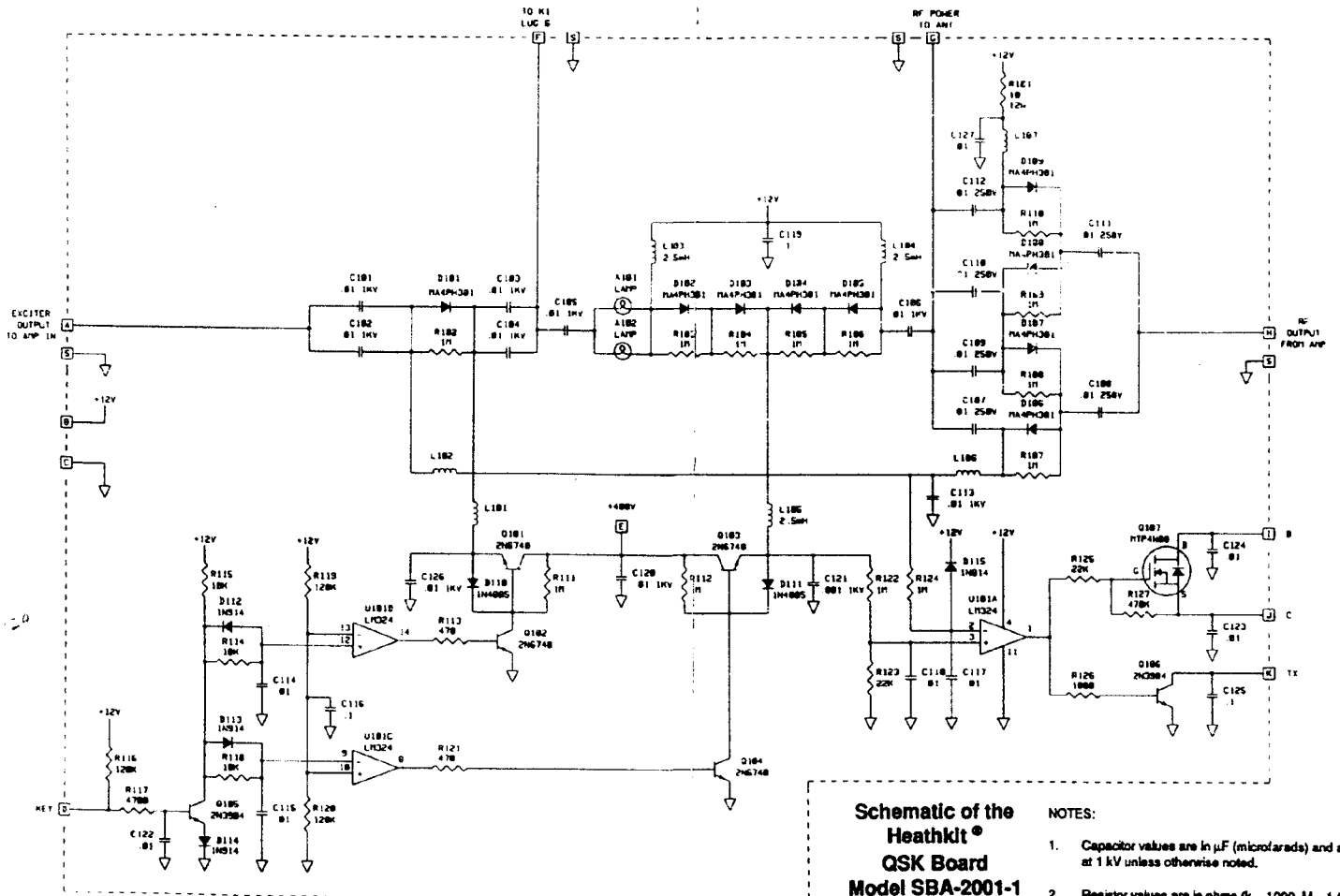

Schematic of the Heathkit® QSK Board Model SBA-2001-1

- NOTES:**
1. Capacitor values are in μF (microfarads) and are rated at 1 kV unless otherwise noted.
 2. Resistor values are in ohms ($k = 1,000$, $M = 1,000,000$) and are rated at 1/2-watt unless otherwise noted.

Heathkit®

Heathkit®

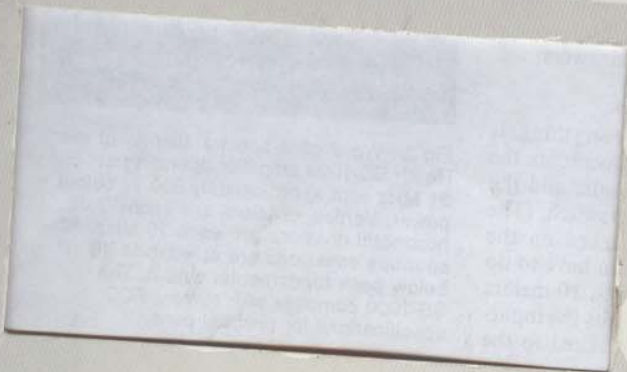

kit®

kit®

Heathkit®

Heathkit®

Heathkit®

Heathkit®

Heath Com
Benton Harbor, M