

Assembly
and
Operation
of the

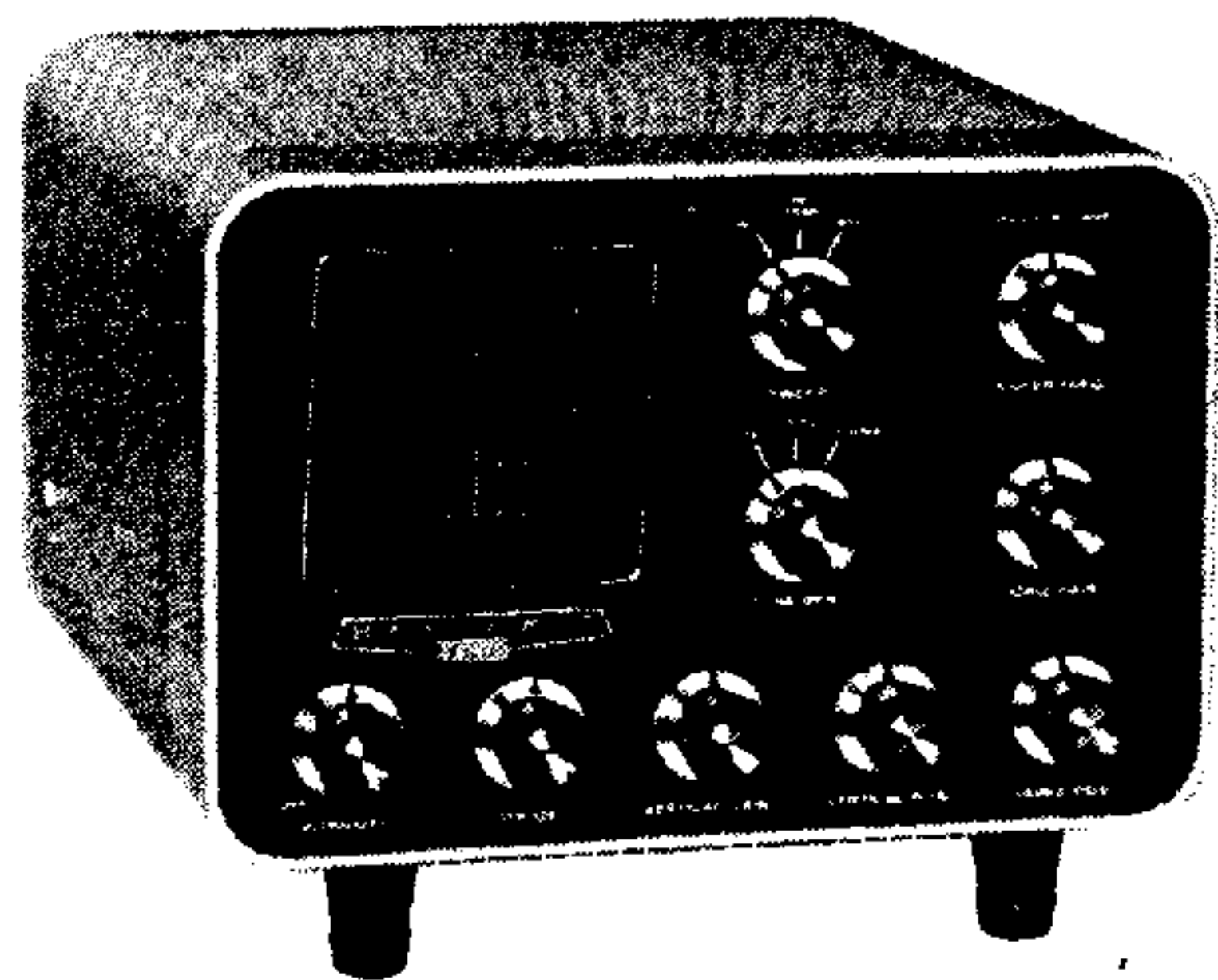

**MÓNITOR
SCOPE**
MODEL SB-610



HEATH COMPANY
BENTON HARBOR,
MICHIGAN 49022

TABLE OF CONTENTS

Introduction.	2
Parts List.	3
Step-By-Step Assembly	
Parts Mounting.	6
Photographs. . .(fold-out from page)...	6
Transformer Wiring.	13
Front Panel Wiring.	23
Alternate Vertical Amplifier Connections.	24
CRT Installation.	27
Converting To Other Vertical Amplifier Applications.	28
Test And Adjustment.	29
2-Tone Generator Adjustment.	30
Control Functions.	32
Installation And Operation.	33
Final Assembly.	40
Transmit Envelope Patterns.	41
Trapezoid Patterns.	44
RTTY Cross Patterns.	45
CW Patterns.	46
In Case Of Difficulty.	48
Troubleshooting Chart.	49
Specifications.	51
Circuit Description.	53
Schematic. . .(fold-out from page).	55
Replacement Parts Price List (fold-out from page).	56
Warranty	Inside front cover
Customer Service	Inside rear cover

REPLACEMENT PARTS PRICE LIST

To order parts, use the Parts Order Form furnished with this kit. If a Parts Order Form is not available, refer to "Replacement Parts" inside the rear cover of the Manual.

<u>PART No.</u>	<u>PRICE Each</u>	<u>DESCRIPTION</u>
RESISTORS		
1/2 Watt		
1-3	.10	100 Ω
1-4	.10	330 Ω
1-13	.10	2700 Ω
1-16	.10	4700 Ω
1-19	.10	6800 Ω
1-21	.10	15 K Ω
1-25	.10	47 K Ω
1-102	.10	82 K Ω
1-26	.10	100 K Ω
1-126	.10	180 K Ω
1-29	.10	220 K Ω
—1-31	.10	330 K Ω
1-35	.10	1 megohm
1-37	.10	2.2 megohm
—1-38	.10	3.3 megohm
1-40	.10	10 megohm
1 Watt		
1-2-1	.10	1000 Ω
1-26-1	.10	15 K Ω
1-27-1	.10	33 K Ω
CAPACITORS		
Mica		
20-52	.15	7.5 $\mu\mu\text{f}$
20-130	.15	12 $\mu\mu\text{f}$
20-99	.15	22 $\mu\mu\text{f}$
20-78	.15	56 $\mu\mu\text{f}$
20-102	.15	100 $\mu\mu\text{f}$
20-108	.20	200 $\mu\mu\text{f}$
20-139	.25	330 $\mu\mu\text{f}$
20-113	.30	470 $\mu\mu\text{f}$
Disc		
21-140	.10	.001 μfd
21-90	.20	.001 μfd 3 KV
21-31	.10	.02 μfd
21-38	.40	.02 μfd 1.6 KV
Other Capacitors		
—28-2	.10	1.0 $\mu\mu\text{f}$ tubular
28-1	.10	2.2 $\mu\mu\text{f}$ tubular
23-11	.35	.1 μfd 600 volt tubular
—23-63	.25	.25 μfd 400 volt tubular

<u>PART No.</u>	<u>PRICE Each</u>	<u>DESCRIPTION</u>
Other Capacitors (cont'd.)		
23-29	.45	.1 μfd 1200 volt tubular
23-94	.90	.15 μfd 1600 volt tubular
23-15	.60	.5 μfd volt tubular
27-34	.25	.2 μfd 200 volt resin
25-54	.40	10 μfd electrolytic
25-41	1.00	40 μfd electrolytic
25-63	1.80	30-20-20-20 μfd electrolytic

CONTROLS-SWITCHES

10-12	.45	100 K Ω control
10-32	.50	1 megohm control
10-57	.35	10 K Ω tab-mount control
10-127	.35	1 megohm tab-mount control
19-78	.85	500 K Ω control with switch
19-76	.95	7.5 megohm control with push-pull switch
63-77	.70	3-position switch (3 lugs)
63-138	.70	4-position switch (5 lugs)
63-418	1.05	3-position switch (8 lugs)

COILS-TRANSFORMERS

40-602	.40	RF coil
40-746	.60	Low frequency coil
40-747	.75	Medium frequency coil
40-748	.55	High frequency coil
45-4	.40	1.1 mh RF choke
—54-182	6.90	Power transformer

DIODES-TUBES-LAMP

56-26	.30	1N191 Germanium diode
57-27	.60	Silicon diode
57-44	1.40	Selenium rectifier
411-142	17.95	3RP1 CRT (cathode ray tube)
411-128	1.60	6BN8 tube
411-167	1.85	6C10 compactron tube
411-170	1.20	6EW6 tube
411-168	2.40	6J11 compactron tube
412-15	.15	Neon lamp

TERMINAL STRIPS

431-14	.10	2-lug
431-2	.10	2-lug
431-32	.10	2-lug with #8 hole
431-12	.10	Small 4-lug
431-44	.10	Large 4-lug
431-42	.10	5-lug

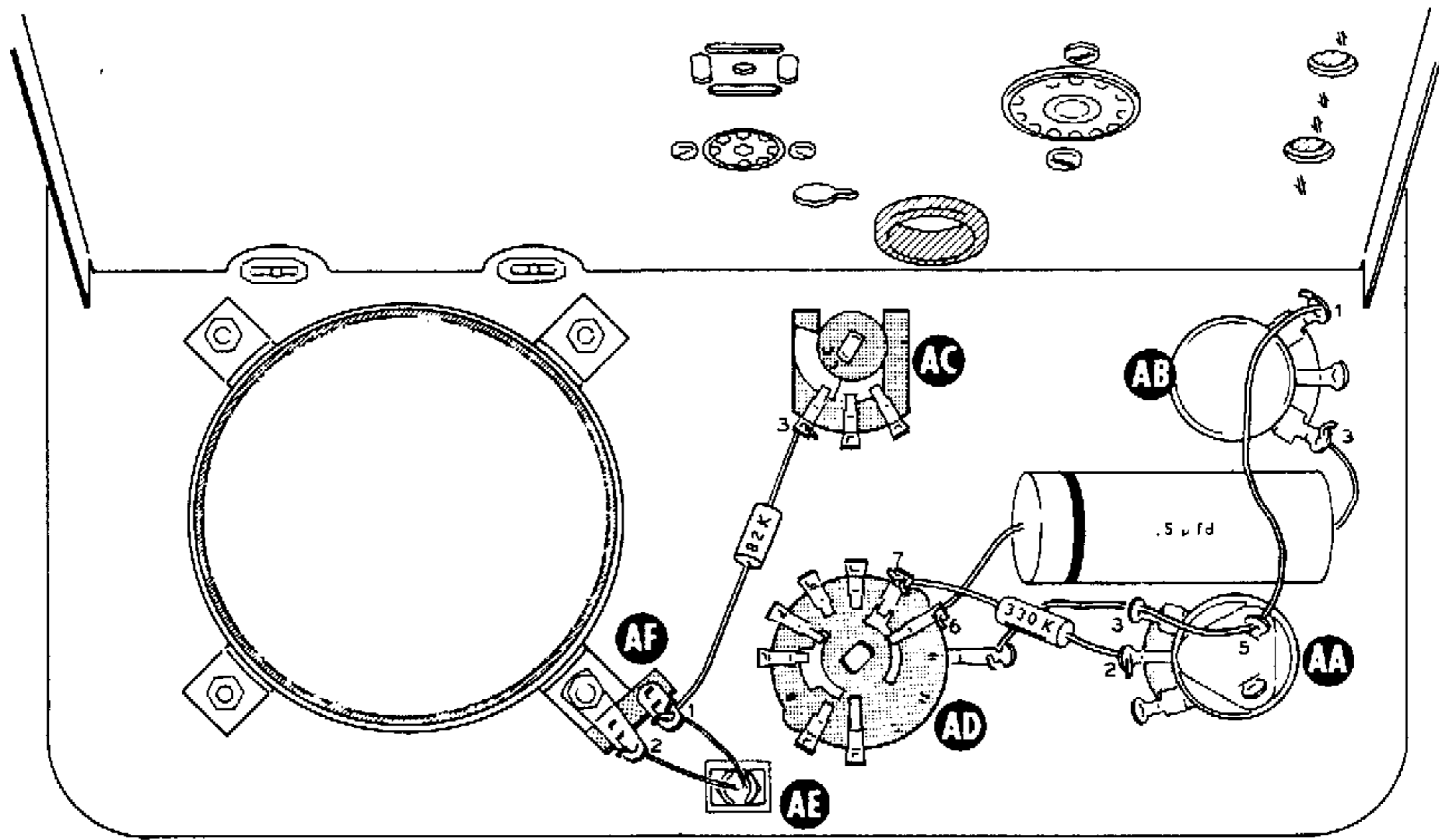

PICTORIAL 9

Refer to Pictorial 9 for the following steps and position the parts as shown.

- (✓) Connect the lead from the marked end of a .5 μfd tubular capacitor to lug 6 of switch AD (S-1). Connect the other lead to lug 3 of control AB (S-1).
- (✓) Remove all of the insulation from a 5-1/2" length of hookup wire. Then connect this wire from lug 1 of control AB (S-1), through lug 5 (S-2) and lug 3 (S-2) of control AA, to the control solder lug of switch AD (S-2).
- (✓) Connect a 330 KΩ (orange-orange-yellow) resistor from lug 2 of control AA (S-1) to lug 7 of switch AD (S-2).
- (✓) Install the red plastic lens at AE with a large speednut as shown in Detail 9A. Then press the neon pilot lamp fully onto the plastic lens.
- (✓) Connect one pilot lamp lead to lug 2 (S-1) and the other lead to lug 1 (NS) of terminal strip AF.

- (✓) Connect an 82 KΩ (gray-red-orange) resistor from lug 1 of terminal strip AF (S-2) to lug 3 of switch AC (S-2).
- (✓) Check to see that all connections to the front panel components are soldered.
- () Tip and shake the whole unit to dislodge any bits of wire or solder that may have fallen into the wiring.

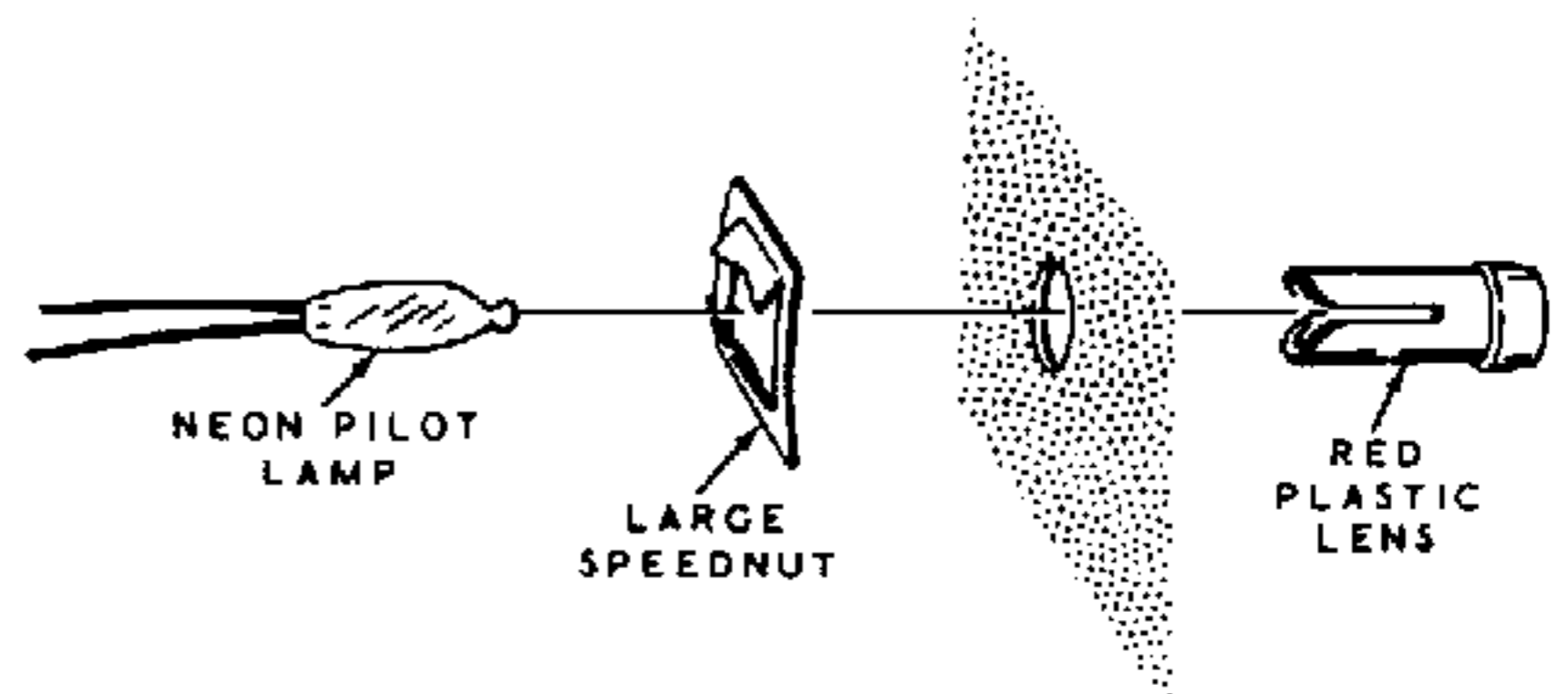

Detail 9A

ALTERNATE VERTICAL AMPLIFIER CONNECTIONS

NOTE: Read the Receiver Monitoring section on Page 33 before you proceed with these Alternate Connections,

Vertical amplifier stage V2 can be wired in any one of the following three ways: to monitor signals between 3000 kc and 6000 kc; to monitor signals between 455 kc and 2475 kc; and to monitor RTTY signals and IF signals between 1 kc and 150 kc. Each of these three ways has its own group of steps. Decide what signal you want to monitor, then use only that group of steps which apply to your signal. You will then be directed to proceed to the CRT Installation steps.

After you have made these vertical amplifier connections, we suggest that you write the frequency (or RTTY) near the VERT input jack on the rear of the Scope.

3000 KC TO 6000 KC (Refer to Figure 3, fold-out from Page 27)

The 3000 kc to 6000 kc alternate connections match the IF frequency of the Heath SB series of amateur equipment.

- () Install the high frequency coil (#40-748) at L2 as shown in Figure 1. Push the mounting clip all the way until the teeth lock into the sides of the can.

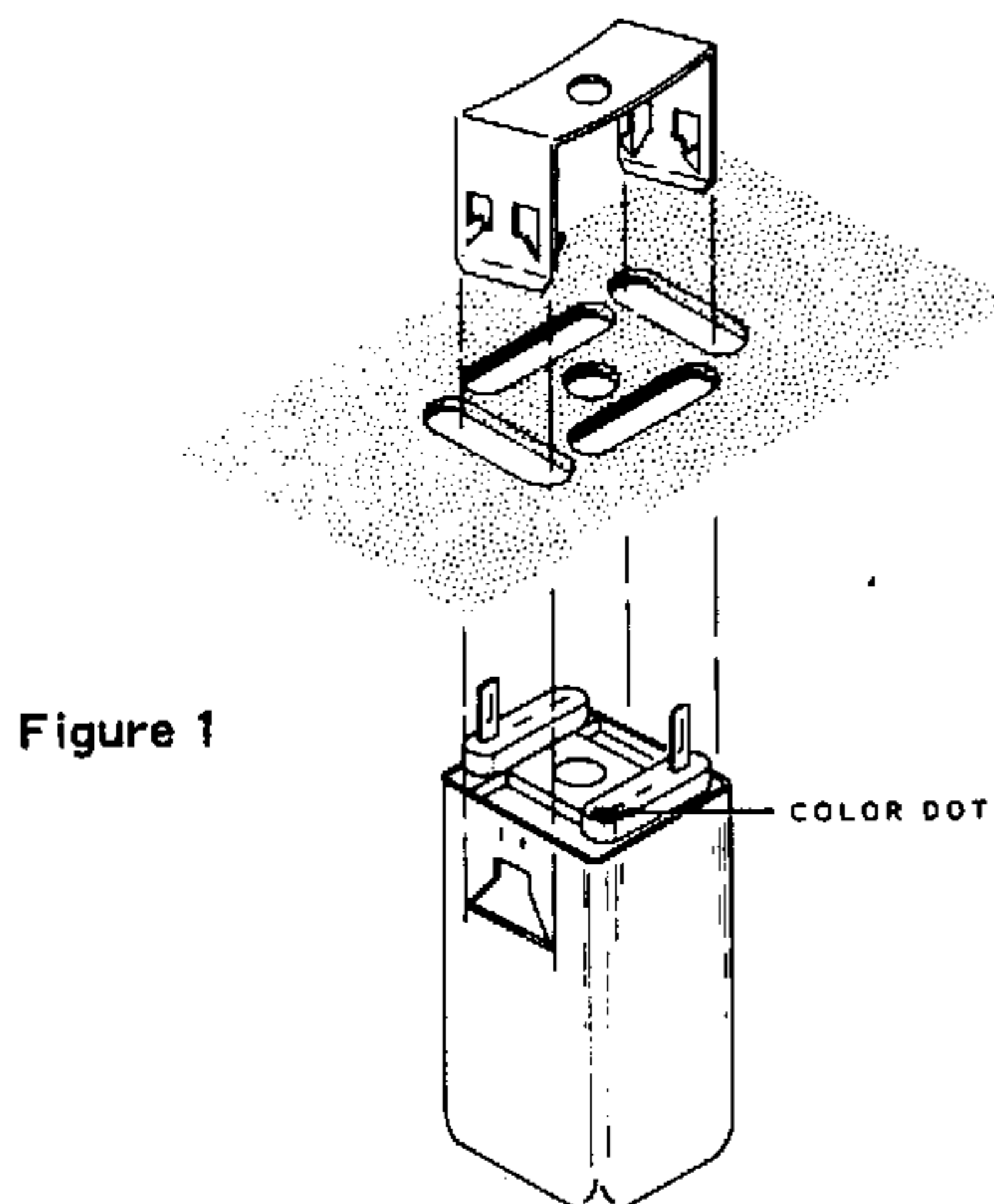

Figure 1

- () Connect a .02 μ fd disc capacitor from lug 3 of terminal strip L (S-2) to lug 2 of coil L2 (NS).
- () Connect a 2" hookup wire from lug 2 of coil L2 (NS) to lug 1 of terminal strip B (S-3).

- () Refer to the chart in Figure 3 (fold-out from Page 27), and select the value of mica capacitor for C2 that is opposite the frequency you want to monitor.
- () Insert one end of the selected capacitor C2 through lug 1 of coil L2 (S-2) to lug 5 of tube socket V2 (S-2). Connect the other end of the capacitor to lug 2 of coil L2 (S-3).
- () Refer to the chart in Figure 3, and select the value of mica capacitor for C1 that is opposite the frequency you want to monitor.
- () Install the RF coil (#40-602) at L1 as shown in Figure 2. Press the coil into the hole until both catches snap to lock the coil to the chassis.

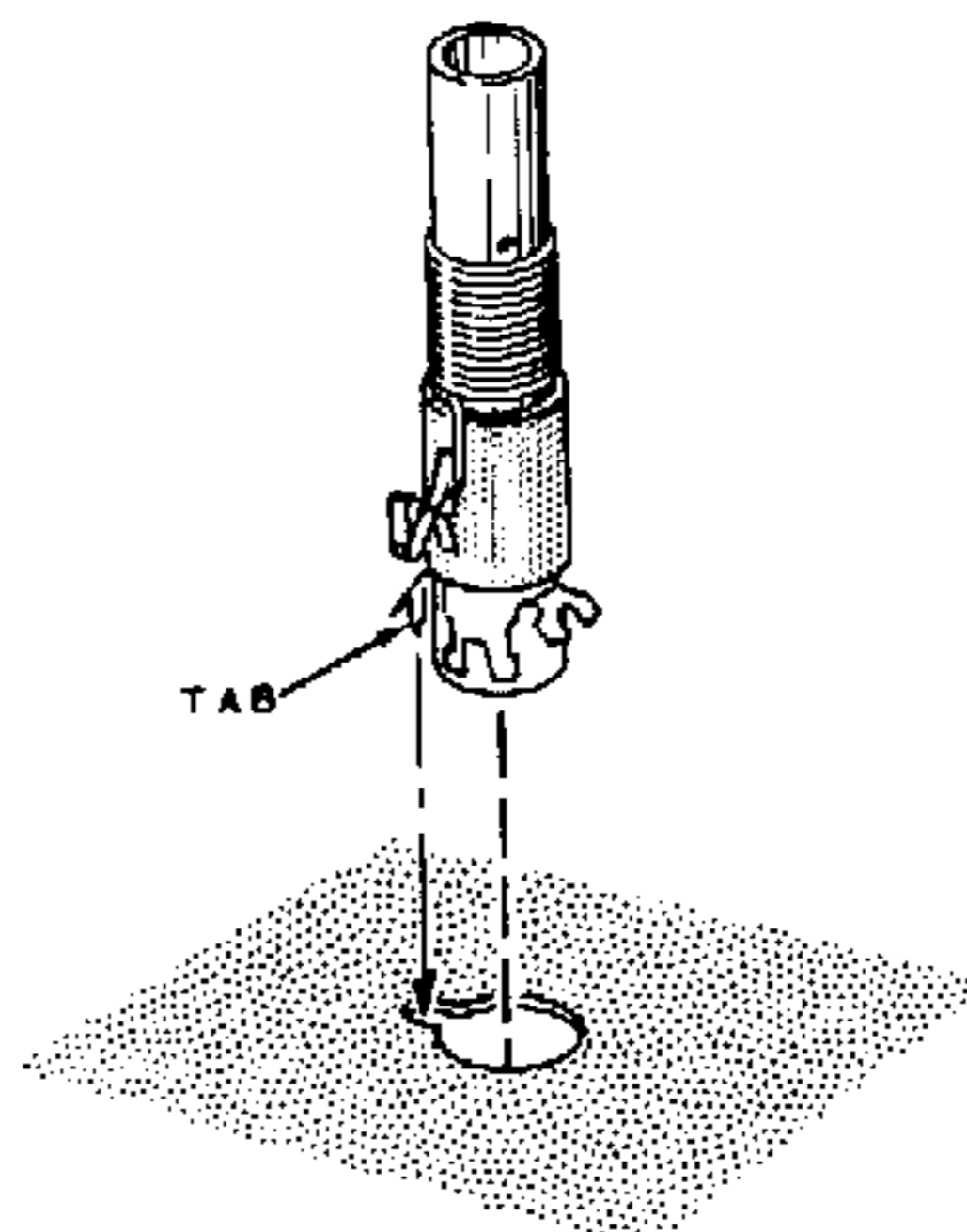

Figure 2

- () Insert one lead of the selected capacitor C1 through lug 2 of coil L1 (NS) to the solder lug at tube socket V2 (S-3). Connect the other capacitor lead to lug 1 of coil L1 (NS).
- () Connect a .001 μ fd disc capacitor from lug 3 of control AJ (S-1) to lug 1 of coil L1 (NS).
- () Connect the shield of the red coaxial cable to lug 2 (S-3) and the inner wire to lug 1 (S-3) of coil L1.
- () Connect a 2700 Ω (red-violet-red) resistor from lug 2 (S-1) of control AJ to lug 1 (S-1) of tube socket V2.
- () Solder the connection at lug 1 (S-1) of control AJ.

This completes the alternate connections for 3000 kc to 6000 kc. Proceed to CRT Installation on Page 27.

455 KC TO 2475 KC (Refer to Figure 4)

- () Refer to the chart in Figure 4 (fold-out from Page 27), and select the value of coil L2 that is opposite the frequency you want to monitor.
- () Install the coil selected for L2 as shown in Figure 1.
- () Connect a .02 μ fd disc capacitor from lug 3 of terminal strip L (S-2) to lug 2 of coil L2 (NS).
- () Connect a 2" hookup wire from lug 2 of coil L2 (NS) to lug 1 of terminal strip B (S-3).
- () Refer to the chart in Figure 4 and select the value of capacitor for C2 that is opposite the frequency you want to monitor.
- () Insert one lead of the selected capacitor C2 through lug 1 of coil L2 (S-2) to lug 5 of tube socket V2 (S-2). Connect the other capacitor lead to lug 2 of coil L2 (S-3).
- () Connect the inner wire of the red coaxial cable to lug 3 (S-1) and the shield to lug 1 (S-2) of control AJ.
- () Connect a 2" hookup wire from lug 2 of control AJ (S-1) to lug 1 of tube socket V2 (S-1).
- () Solder the connection at the solder lug of tube socket V2 (S-2).

This completes the alternate connections for 455 kc to 2475 kc. Proceed to CRT Installation on Page 27.

RTTY AND 1 KC TO 150 KC (Refer to Figure 5)

- (✓) Connect a 15 K Ω (brown-green-orange) 1 watt resistor from lug 1 (NS) of terminal strip B to lug 5 (S-2) of tube socket V2.

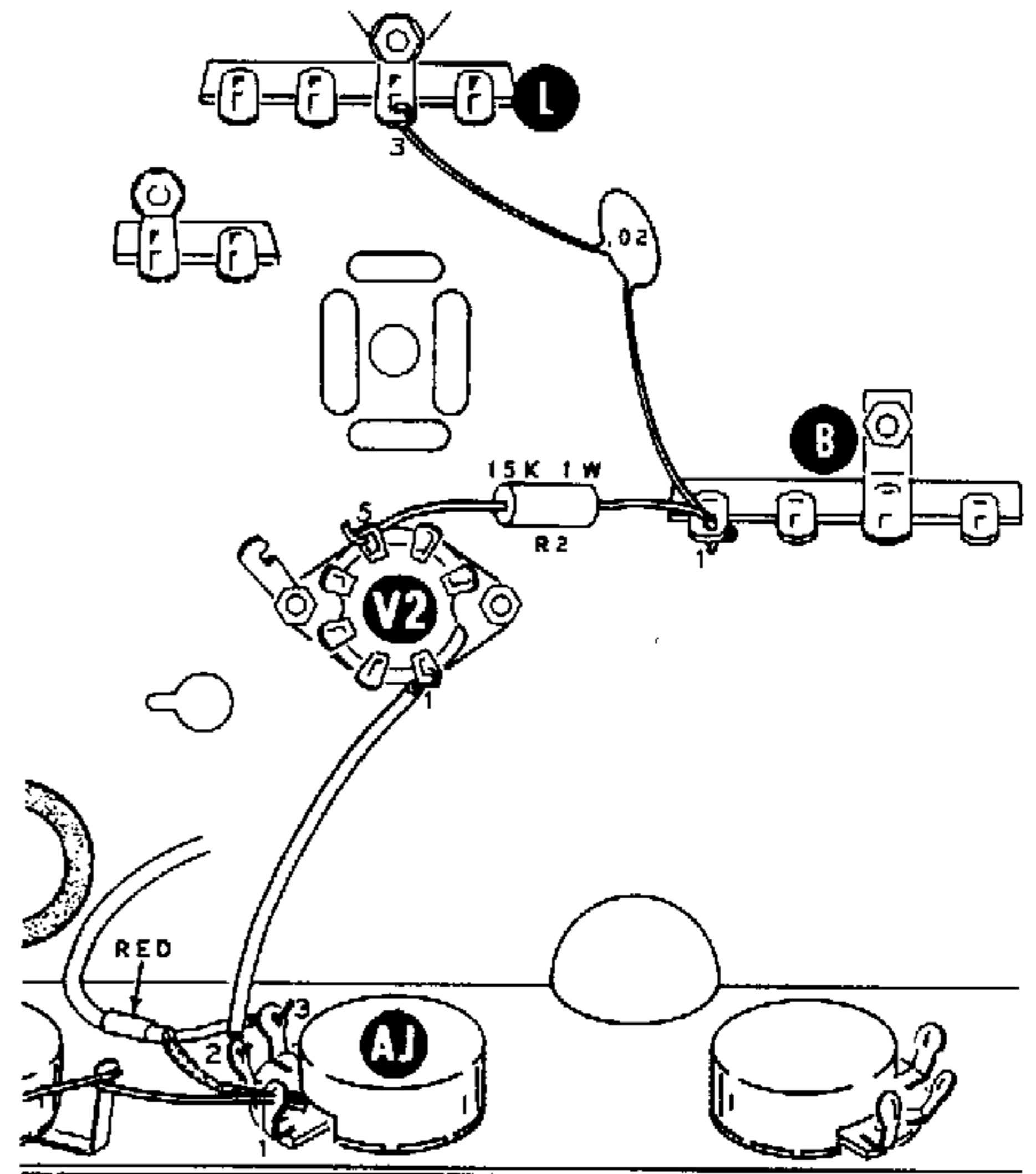
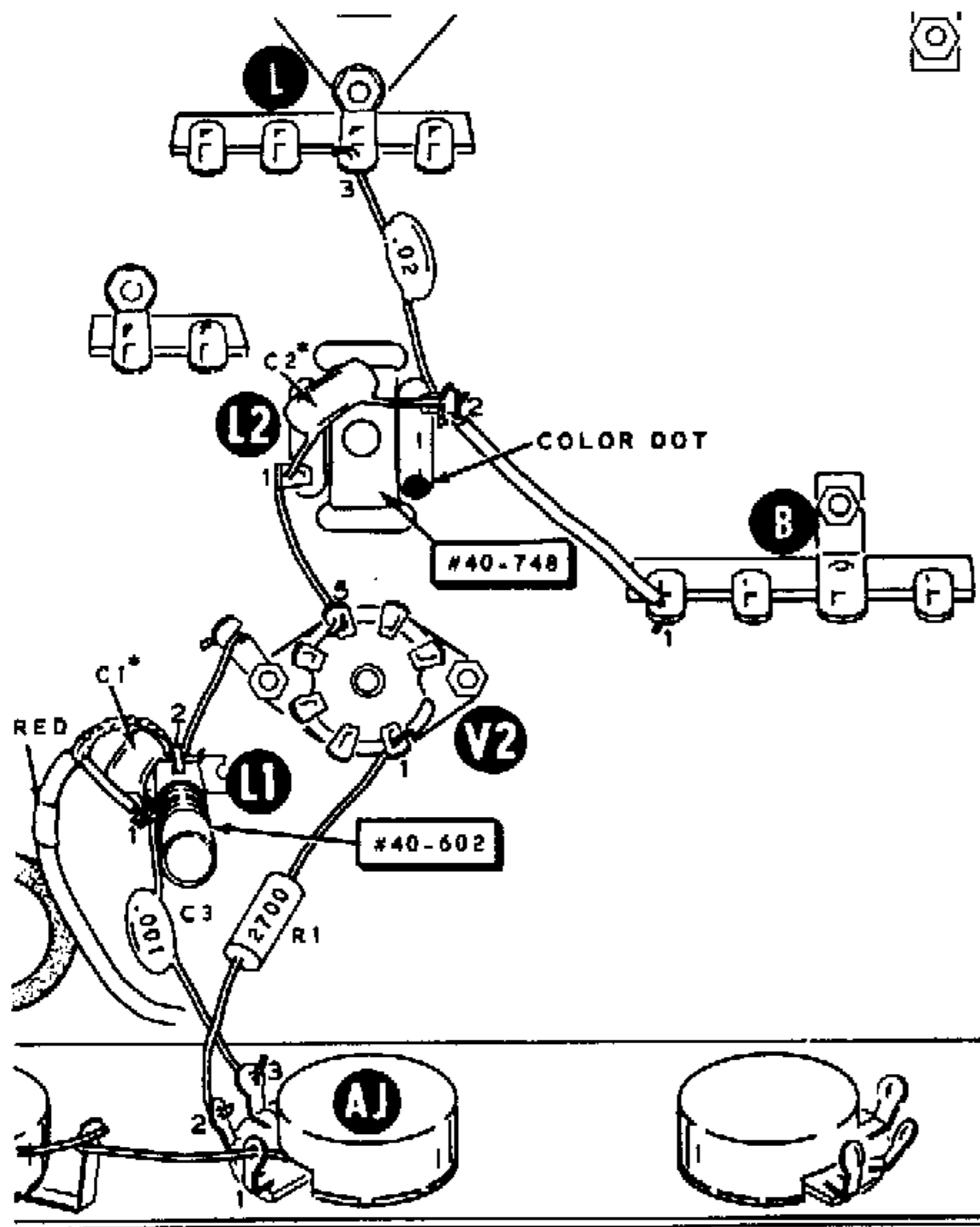

Figure 5

- (✓) Connect a .02 μ fd disc capacitor from lug 3 of terminal strip L (S-2) to lug 1 of terminal strip B (S-4).
- (✓) Connect the inner wire of the red coaxial cable to lug 3 (S-1) and the shield to lug 1 (S-2) of control AJ.
- (✓) Connect a 2" hookup wire from lug 2 (S-1) of control AJ to lug 1 (S-1) of tube socket V2.
- (✓) Solder the connection at the solder lug of tube socket V2 (S-2).

This completes the alternate connections for RTTY and 1 kc to 150 kc. Proceed to CRT Installation on Page 27.

All wiring and soldering is now complete. Carefully examine all connections to make sure they are soldered, and shake the chassis to dislodge any bits of wire or solder splashes that may be lodged in the wiring.



3000 KC To 6000 KC

Frequency	C1*	C2*
3000 kc	470 $\mu\mu\text{f}$	100 $\mu\mu\text{f}$
3055 kc	470 $\mu\mu\text{f}$	100 $\mu\mu\text{f}$
3395 kc	330 $\mu\mu\text{f}$	100 $\mu\mu\text{f}$
5000-6000 kc	100 $\mu\mu\text{f}$	12 $\mu\mu\text{f}$

FIGURE 3

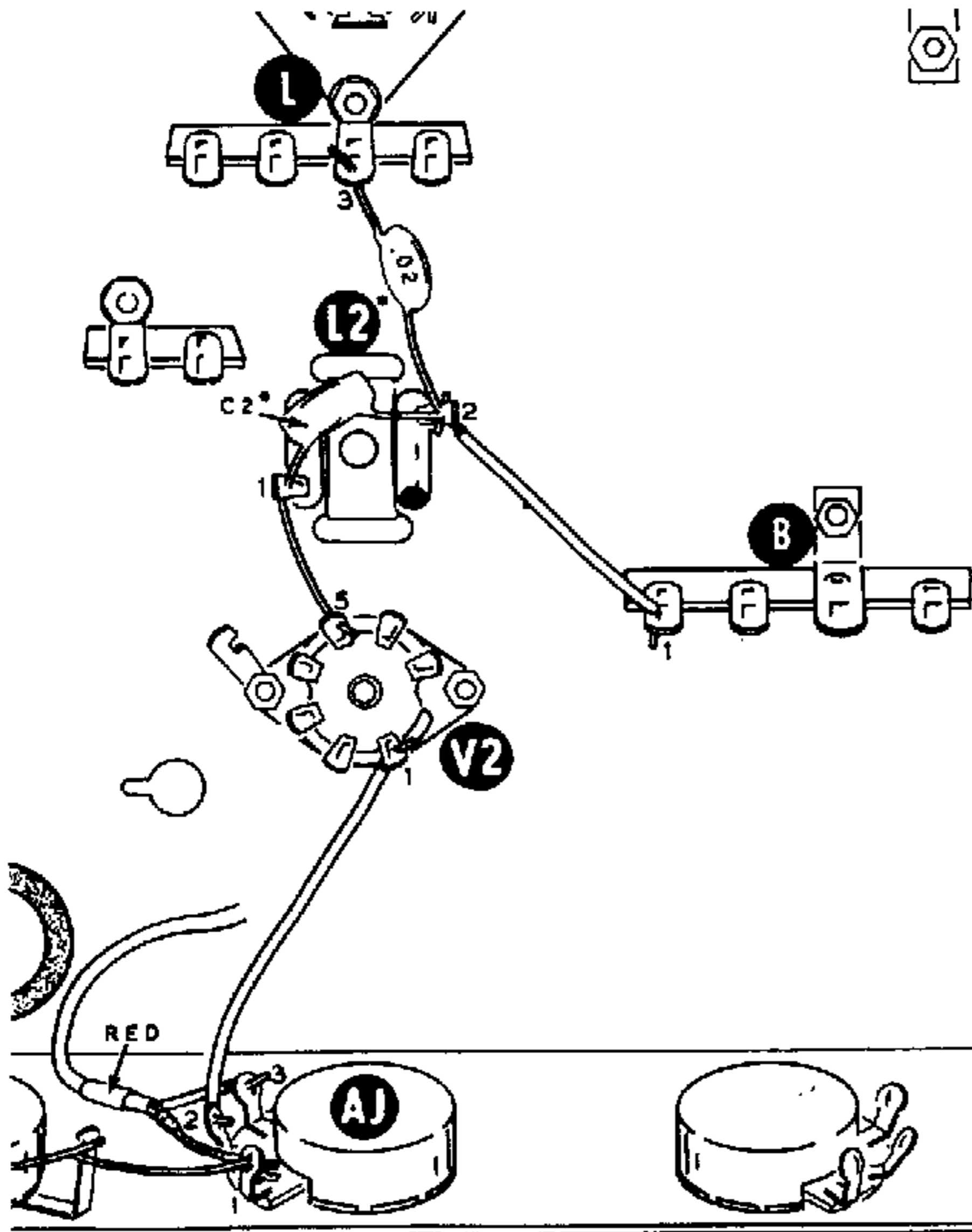

455 KC To 2475 KC

FREQUENCY	L2*	C2*
455 kc	40-746	200 $\mu\mu\text{f}$
1000 kc	40-747	200 $\mu\mu\text{f}$
1600-1680 kc	40-747	100 $\mu\mu\text{f}$
2075 kc	40-747	56 $\mu\mu\text{f}$
2215 kc	40-747	56 $\mu\mu\text{f}$
2475 kc	40-747	56 $\mu\mu\text{f}$

FIGURE 4

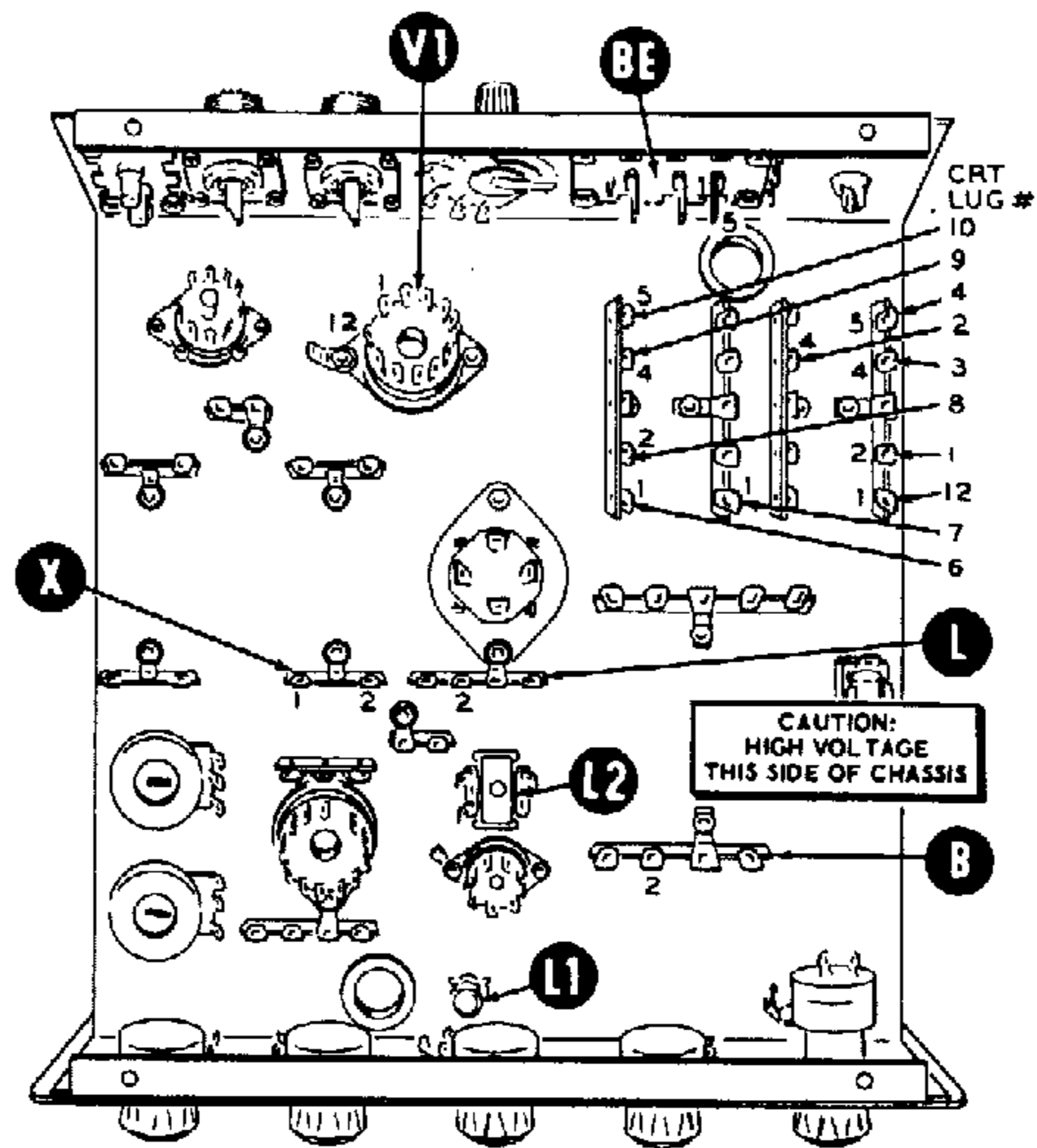
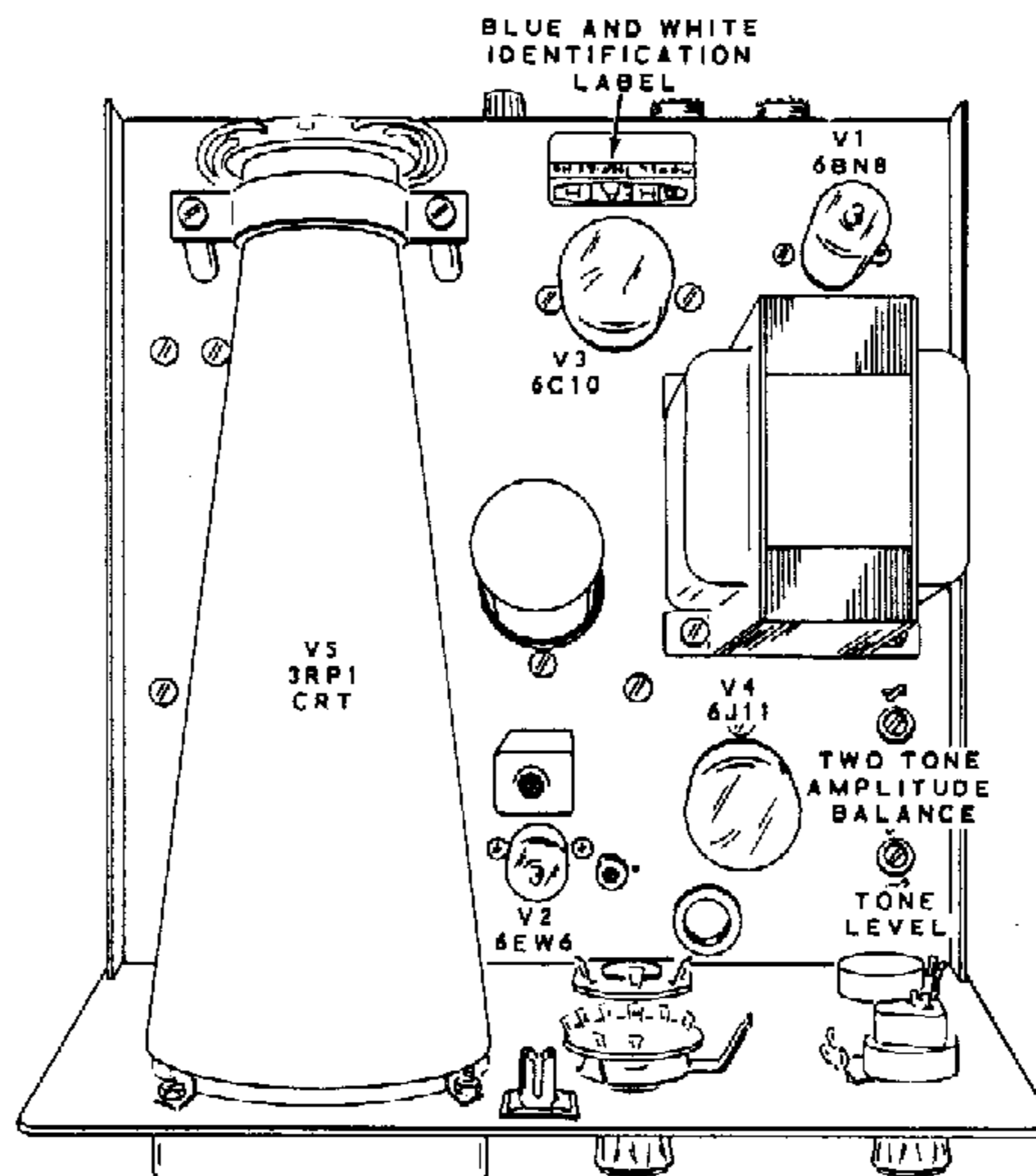
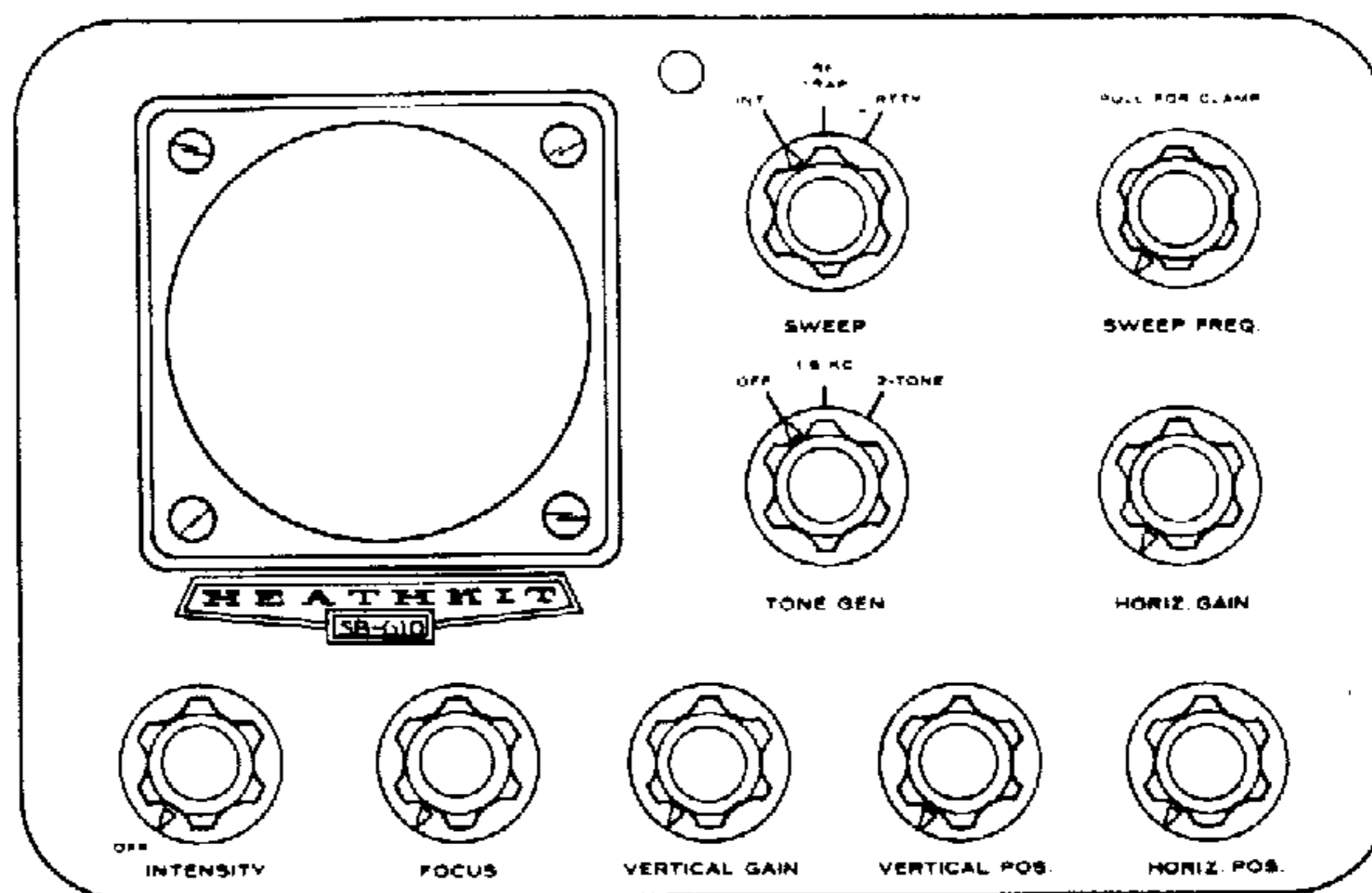

FIGURE 6



PICTORIAL 12

PICTORIAL 11



Refer to Pictorial 11 for the following steps.

- (✓) Start an 8-32 x 1/4" setscrew into the threaded hole of each skirted knob.
- (✓) Turn the shafts of all controls and switches fully counterclockwise.
- (✓) Install a skirted knob on each shaft on the front panel. Position the pointer marks as shown and tighten the setscrews.
- (✓) Install a 6-32 x 1/8" setscrew in the small knob.
- (✓) Install the small knob on the shaft of the XMTR. ATTEN switch on the rear of the chassis. Tighten the setscrew.
- (✓) Refer to Pictorial 12 and install the tubes in their proper sockets.
- (✓) Install a 1/2 ampere slow-blow fuse in fuse block A. (NOTE: Install a 1/4 ampere slow-blow fuse if the Monitor Scope was wired for 210-250 volt operation. This fuse is not furnished with the kit.)

NOTE: The blue and white identification label that is installed in the next step shows the Model number and Production series number of your kit.

Refer to these numbers in any communications with the Heath Company; this assures you that you will receive the most complete and up-to-date information in return.

- () Carefully peel away the backing paper from the blue and white identification label. Then press the label onto the chassis at the location shown in Pictorial 12.

CONVERTING TO OTHER VERTICAL AMPLIFIER APPLICATIONS

At some future time you may want to convert the vertical amplifier section of the Scope for use with a different frequency, or for RTTY. To do this, refer to the Alternate Connections section that begins on Page 24 of this Manual. Reverse the procedure that was used in assembling that section, and unsolder the parts you installed in the circuit of vertical amplifier V2. Then wire your vertical amplifier for the new frequency by following the proper group of assembly steps.

Be sure to go through the Test and Adjustment section and the Installation and Operation section again to readjust the Scope for the new application.

TEST AND ADJUSTMENT

INITIAL CHECKS

If an ohmmeter is available, make the following checks **BEFORE YOU APPLY POWER** to the unit. Refer to Figure 6 for location of the test points indicated. If the correct response is not obtained in these steps, refer to the In Case Of Difficulty section on Page 48.

- (✓) Connect the negative meter lead to chassis ground and the positive lead to lug 2 of terminal strip B; the resistance reading should be approximately 5 megohms or more, after a brief time is allowed for the capacitors to charge.
- (✓) Connect the negative meter lead to chassis ground and the positive lead to lug 2 of terminal strip L; the resistance reading should be greater than 100 K Ω after a brief time is allowed for the capacitors to charge.
- (✓) Connect the negative lead to lug 2 of terminal strip L and the positive lead to lug 1 of terminal strip X; the resistance reading should be greater than 100 K Ω after a brief time is allowed for the capacitors to charge.

CAUTION: VOLTAGES IN THIS INSTRUMENT ARE DANGEROUS. Use extreme care whenever the unit is operated or handled without being installed in its cabinet. Some of the highest voltages in the Scope appear at the terminations of the CRT socket leads on terminal strips D, E, F, and G, and on the terminals of the INTENSITY control. These voltages could be fatal. Anytime a part in the Scope must be handled, turn off the power and use a screwdriver with an insulated handle to short out the positive (+) leads of the large electrolytic capacitors to the chassis.

Read this section of the Manual all the way through so you will understand the overall operation of the Scope before you perform the following steps or apply power to the unit.

- () Set the controls as follows before you connect the line cord to an AC outlet. Refer to Pictorial 12 for the location of the last two controls.

SWEEP - INTERNAL.
 SWEEP FREQUENCY - Fully counterclockwise and pushed in.
 TONE GENERATOR - OFF.
 HORIZONTAL GAIN - Fully counterclockwise.
 HORIZONTAL POSITION - Center of rotation.
 VERTICAL POSITION - Center of rotation.
 VERTICAL GAIN - Fully counterclockwise.
 FOCUS - Center of rotation.
 INTENSITY - OFF.
 TONE LEVEL - Fully clockwise.
 TWO TONE AMPLITUDE BALANCE - Fully clockwise.

- (✓) Plug the line cord into an electrical outlet supplying the voltage for which the Monitor Scope was wired. (105-125 or 210-250 VAC 50/60 cps). CAUTION: Severe damage may result if this instrument is connected to the wrong voltage or to a DC power source.
- (✓) Turn the INTENSITY control approximately 3/4 of its rotation. The neon pilot lamp and all tube filaments should glow. Allow one minute for the tubes to warm up.
- (✓) A spot should appear near the center of the screen. If no spot appears, rotate the HORIZ POS (Horizontal Position) and the VERTICAL POS (Vertical Position) knobs simultaneously until the spot is located. If the spot cannot be located, turn off the unit and refer to the In Case Of Difficulty section on Page 48.

NOTE: The neon pilot lamp may not go out immediately when the power is turned off. This is normal, as the lamp is connected to the B+ circuit, and the electrolytic capacitors discharge slowly.

PARTS LIST

The numbers in parentheses in the Parts List are keyed to the numbers in the Parts Pictorial (fold-out from Page 5).

To order replacement parts, refer to the Replacement Parts Price List and use the Parts Order Form furnished with this kit.

PART No.	PARTS Per Kit	DESCRIPTION	PART No.	PARTS Per Kit	DESCRIPTION
RESISTORS			Disc		
1/2 Watt			(4) 21-140	9	.001 μ fd
(1) 1-3	1	100 Ω (brown-black-brown)	(5) 21-90	1	.001 μ fd 3 KV
1-4	1	330 Ω (orange-orange-brown)	21-31	7	.02 μ fd
1-13	4	2700 Ω (red-violet-red)	21-38	1	.02 μ fd 1.6 KV
1-16	1	4700 Ω (yellow-violet-red)	Other Capacitors		
1-19	5	6800 Ω (blue-gray-red)	(6) 28-2	1	1.0 μ fd tubular (brown-black-white)
1-21	1	15 K Ω (brown-green-orange)	28-1	2	2.2 μ fd tubular (red-red-white)
1-25	5	47 K Ω (yellow-violet-orange)	(7) 23-11	1	.1 μ fd 600 volt tubular
1-102	2	82 K Ω (gray-red-orange)	23-63	2	.25 μ fd 400 volt tubular
1-26	2	100 K Ω (brown-black-yellow)	(8) 23-29	2	.1 μ fd 1200 volt tubular
1-126	2	180 K Ω (brown-gray-yellow)	23-94	1	.15 μfd 1600 volt tubular
1-29	3	220 K Ω (red-red-yellow)	23-15	1	.5 μ fd 400 volt tubular
1-31	6	330 K Ω (orange-orange-yellow)	(9) 27-34	2	.2 μ fd 200 volt resin
1-35	4	1 megohm (brown-black-green)	(10) 25-54	2	10 μ fd electrolytic
1-37	1	2.2 megohm (red-red-green)	(11) 25-41	2	40 μ fd electrolytic
1-38	2	3.3 megohm (orange-orange-green)	(12) 25-63	1	30-20-20-20 μ fd electrolytic
1-40	1	10 megohm (brown-black-blue)	CONTROLS-SWITCHES		
1 Watt			(13) 10-12	1	100 K Ω control
(2) 1-2-1	3	1000 Ω (brown-black-red)	10-32	4	1 megohm control
1-26-1	2	15 K Ω (brown-green-orange)	(14) 10-57	1	10 K Ω tab-mount control
1-27-1	1	33 K Ω (orange-orange-orange)	10-127	1	1 megohm tab-mount control
CAPACITORS			(15) 19-78	1	500 K Ω control with switch
Mica			(16) 19-76	1	7.5 megohm control with push-pull switch
(3) 20-52	2	7.5 μ fd	(17) 63-77	1	3-position switch (3 lugs)
20-130	2	12 μ fd	(18) 63-138	1	4-position switch (5 lugs)
20-99	2	22 μ fd	(19) 63-418	1	3-position switch (8 lugs)
20-78	1	56 μ fd	COILS-TRANSFORMERS		
20-102	2	100 μ fd	(20) 40-602	1	RF coil
20-108	3	200 μ fd	(21) 40-746	1	Low frequency coil
20-139	1	330 μ fd	40-747	1	Medium frequency coil
20-113	1	470 μ fd	40-748	1	High frequency coil
			(22) 45-4	1	1.1 mh RF choke
			(23) 54-182	1	Power transformer

- (✓) Adjust the INTENSITY control until the spot is clearly visible, but not too bright.
- (✓) Adjust the FOCUS control for the smallest, sharpest spot.
- (✓) Rotate the HORIZ POS control and notice that the dot moves horizontally across the screen. Now turn the VERTICAL POS control and the dot will move up and down. Adjust these two controls to center the dot on the screen.
- (✓) With the dot centered, slowly turn the HORIZ (Horizontal) GAIN control clockwise. The spot should now become a horizontal line.

NOTE: If the horizontal line is not parallel with the horizontal lines on the grid screen, perform the following four steps. If the lines are parallel, these four steps can be omitted.

- (✓) Observe the slant of the trace on the CRT and estimate how far the CRT should be turned to make the trace horizontal.
- (✓) Turn off the power and unplug the line cord. Use a screwdriver with an insulated handle and momentarily short the positive (+) leads of the large electrolytic capacitors to ground. This will assure a complete discharge.
- (✓) Loosen the clamp at the base of the CRT and rotate the tube the amount estimated to make the trace horizontal. Do not allow the tube to move forward and come into contact with the grid screen.
- (✓) Plug in the power cord and turn the unit on. Check to see that the line is horizontal.

This process may be repeated if the trace is still tilted. Be sure to retighten the clamp at the base of the CRT when finished.

- (✓) Turn the SWEEP switch to RF TRAP. There should now be a dot on the screen. Pull the CLAMP switch on the sweep frequency control and the dot should move off of the screen to the right.

- (✓) Push the CLAMP switch into its off position and turn the SWEEP switch to RTTY. There should again be a dot which can be clamped off of the screen by pulling the CLAMP switch. Leave the CLAMP switch in the off (pushed in) position and return the SWEEP switch to RF TRAP.

2-TONE GENERATOR ADJUSTMENT

The 1500 ~ and 1950 ~ tone generators should be adjusted with a single sideband (SSB) transmitter to provide equal outputs from each tone.

Read through the INSTALLATION And OPERATION section of this Manual before you proceed with the tone generator adjustments. Be sure the Scope is not plugged into the power line until all connections are made in the following steps.

- (✓) Set the controls as directed under Initial Control Settings in the Control Functions section (Page 32), except the SWEEP switch, which should be in the INT position.
- (✓) Connect the Scope as shown in Figure 7.

CAUTION: Use extreme care while you follow these steps. High voltage will be present at several points in the Scope and transmitter.

- (✓) Plug the power cord into the AC line. Turn on the Scope and the transmitter. Allow a full minute for warmup.
- (✓) Set the TONE GEN (Generator) switch in the OFF position.

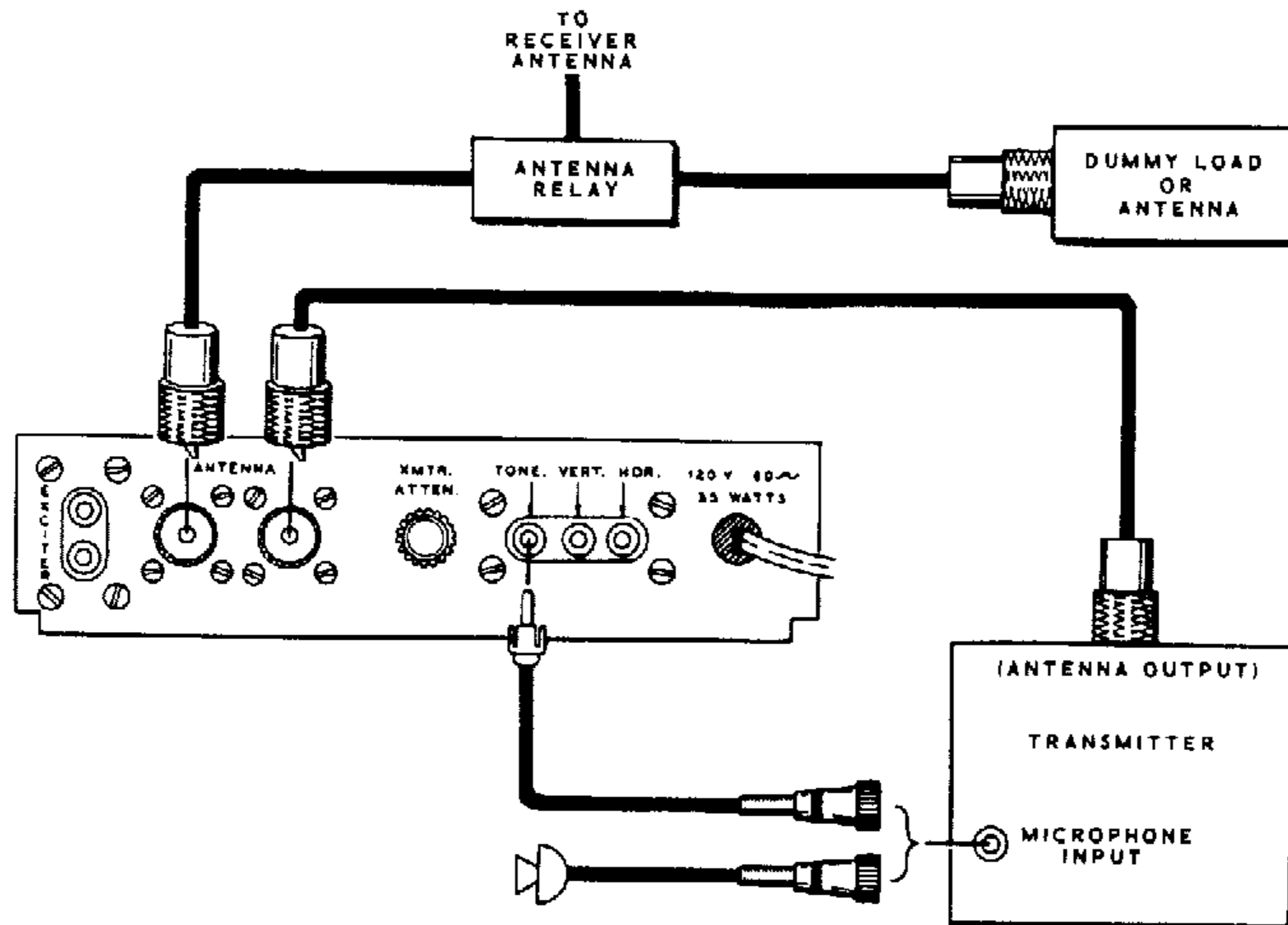

Figure 7

✓ Go through the normal procedure for tuning the transmitter and observe the pattern on the screen.

✓ Reduce the transmitter drive until the Scope display is approximately 1/4" high.

NOTE: Refer to Pictorial 12 for the location of the Tone Adjustment controls.

IMPORTANT: Be sure the transmitter microphone gain control is set for normal speech input from your microphone for the following adjustments.

✓ While transmitting in the SSB mode, turn the TONE GEN switch to the 1.5 KC position and adjust the TONE LEVEL control for maximum deflection on the scope.

✓ Turn the TONE GEN switch to the 2-TONE position. Adjust the TWO TONE AMPLI-

TUDE BALANCE control for a 2-tone display with a clean "trough" crossover as shown in Pattern 10 on Page 42.

This completes the Initial Test and Adjustment of the Monitor Scope. If the Scope is to be used with receivers having an IF frequency below 455 kc, or for RTTY, it may now be installed in the cabinet (see Page 40). Then return to the Control Functions section on Page 32.

For use with receivers having an IF frequency of 455 kc to 6000 kc, proceed to the Control Functions section and the Installation and Operation section on the next pages.

For citizen's band transceiver monitoring, refer to Page 39. Then return to the Control Functions section on Page 32.

CONTROL FUNCTIONS

GENERAL

Before you attempt to use the Scope, familiarize yourself with the operation of its controls. They are listed below in the usual sequence of operation.

Intensity

The INTENSITY control, which also incorporates the AC Power switch, varies the brightness of the pattern on the screen. It should be adjusted for a clear trace. CAUTION: Excessive brightness for prolonged periods of time could burn the phosphor on the face of the CRT.

Focus

This control is used to adjust for a clear sharp trace. There may be some interaction between the FOCUS and INTENSITY controls. Adjust them for the best focus at the desired intensity level.

Horiz Pos/Vertical Pos

These controls determine the position of the trace on the CRT screen. During initial set up, these controls should be set to the center of their rotation.

Horiz Gain

The HORIZ GAIN control varies the input to the horizontal amplifier. Adjust this control for the desired horizontal width.

Vertical Gain

The VERTICAL GAIN control varies the input to the vertical amplifier during receiver monitoring conditions. Under transmit conditions, the vertical height can be varied with the XMTR ATTN (Transmitter Attenuator) switch, located on the rear panel of the Scope.

Sweep

The SWEEP switch determines the source of the horizontal sweep; that is, it determines which type of pattern will be displayed on the screen: INT (Internal) horizontal sweep, RF TRAP (Trapezoid), or RTTY (Radioteletype cross pattern).

Tone Gen

The TONE GEN switch controls operation of the built-in sine wave oscillators. By turning it to the desired position, either a single 1500 cps tone or the 2-tones, 1500 and 1950 cps superimposed, may be obtained.

Sweep Freq

This control adjusts the sweep generator frequency. It should be adjusted to obtain the proper sweep rate for the desired display pattern.

Clamp

When the SWEEP switch is in the RF TRAP or RTTY position, the CLAMP switch may be pulled out to deflect the spot off the side of the screen when there is no output from the transmitter. Otherwise, if a focused spot is left stationary for a long period of time, it may result in a phosphor burn on the face of the CRT.

When used with transmitters of sufficient power input (generally in excess of 100 watts), the clamp will automatically "release" and revert to a normal trapezoid pattern with the application of RF through the ANT (antenna) terminals. When used with lower powered transmitters, the clamp feature is best left off, otherwise the clamp will not release completely or allow a stationary pattern.

INITIAL CONTROL SETTINGS

Each time a different setup is used for monitoring, set the front panel controls as follows:

- SWEEP Switch - Desired horizontal sweep.
- SWEEP FREQ - Pushed in and at 12 o'clock position.
- TONE GEN - As required.
- HORIZ GAIN - 12 o'clock.
- HORIZ POS - 12 o'clock.
- VERTICAL POS - 12 o'clock.
- VERTICAL GAIN - 12 o'clock.
- FOCUS - 12 o'clock.
- INTENSITY - 3 o'clock.

After a pattern is present on the screen of the Scope, adjust the controls for the desired display.

INSTALLATION AND OPERATION

In addition to the following, much information on the use of oscilloscopes for amateur test and monitor purposes may be found in recent editions of "The Radio Amateur's Handbook," published by the American Radio Relay League.

RECEIVER MONITORING (Figure 8)

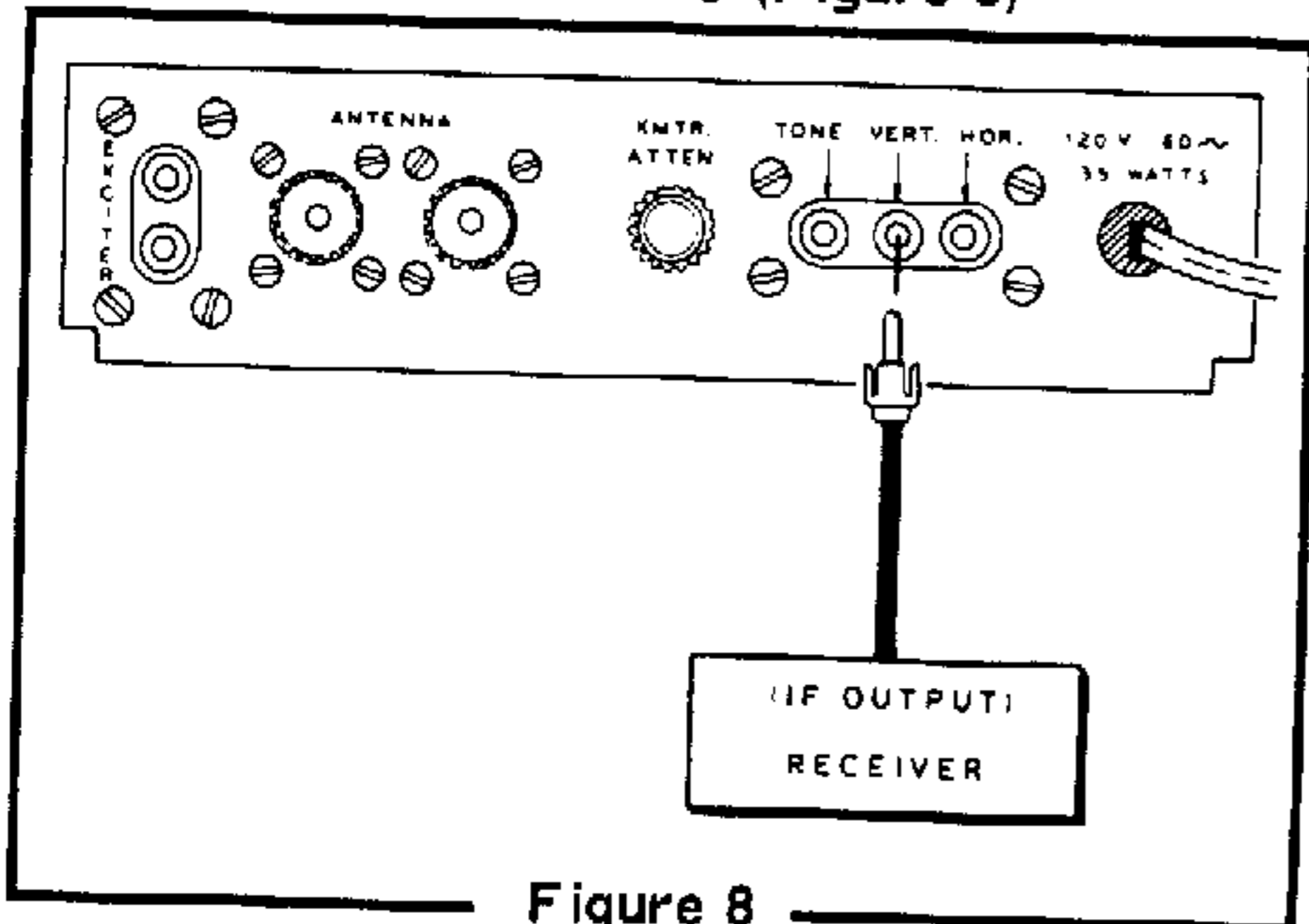

Figure 8

This Monitor Scope can be used with any tube-type receiver that has one of the following IF amplifier frequencies: 50 to 150 kc, 455 kc, 1000 kc, 1600 to 1680 kc, 2075 to 2475 kc, 3000 kc, 3055 kc, 3395 kc, and 5000 to 6000 kc. Consult your receiver manual to determine the IF frequency used in your receiver. In multiple conversion receivers, use the frequency of the last IF stage. NOTE: The correct vertical amplifier components for the IF frequency of your receiver should have been installed in the Alternate Vertical Amplifier Connections part of the Step-By-Step Assembly.

The Scope must be connected in the following manner to the last IF stage of the receiver. A typical circuit is shown in Figure 9. The coupling capacitance must be kept small to prevent excessive loading and detuning effects in the IF amplifier stage. Three coupling capacitors (1.0 μf , 2.2 μf , and 12 μf) are supplied for this purpose.

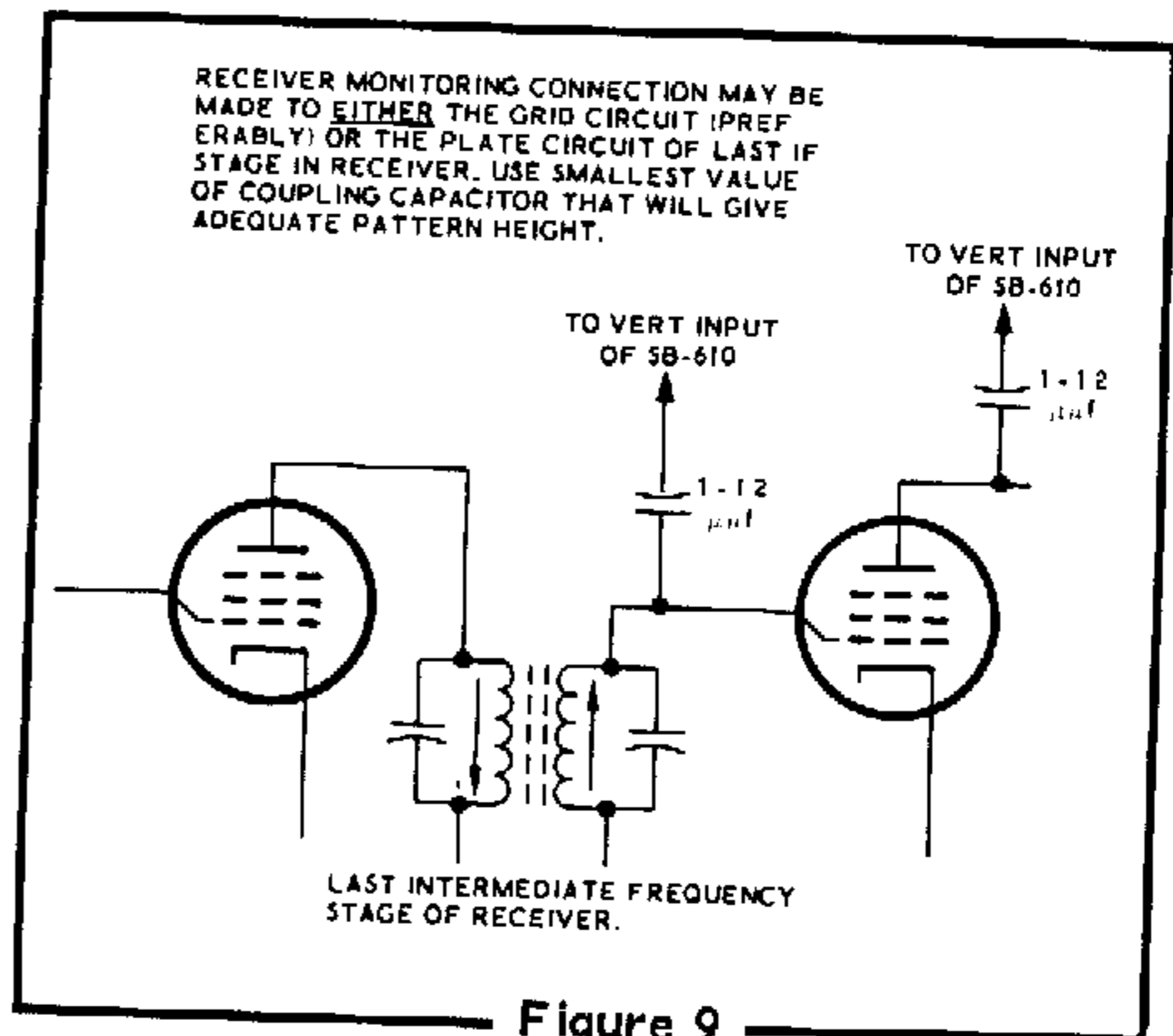

Figure 9

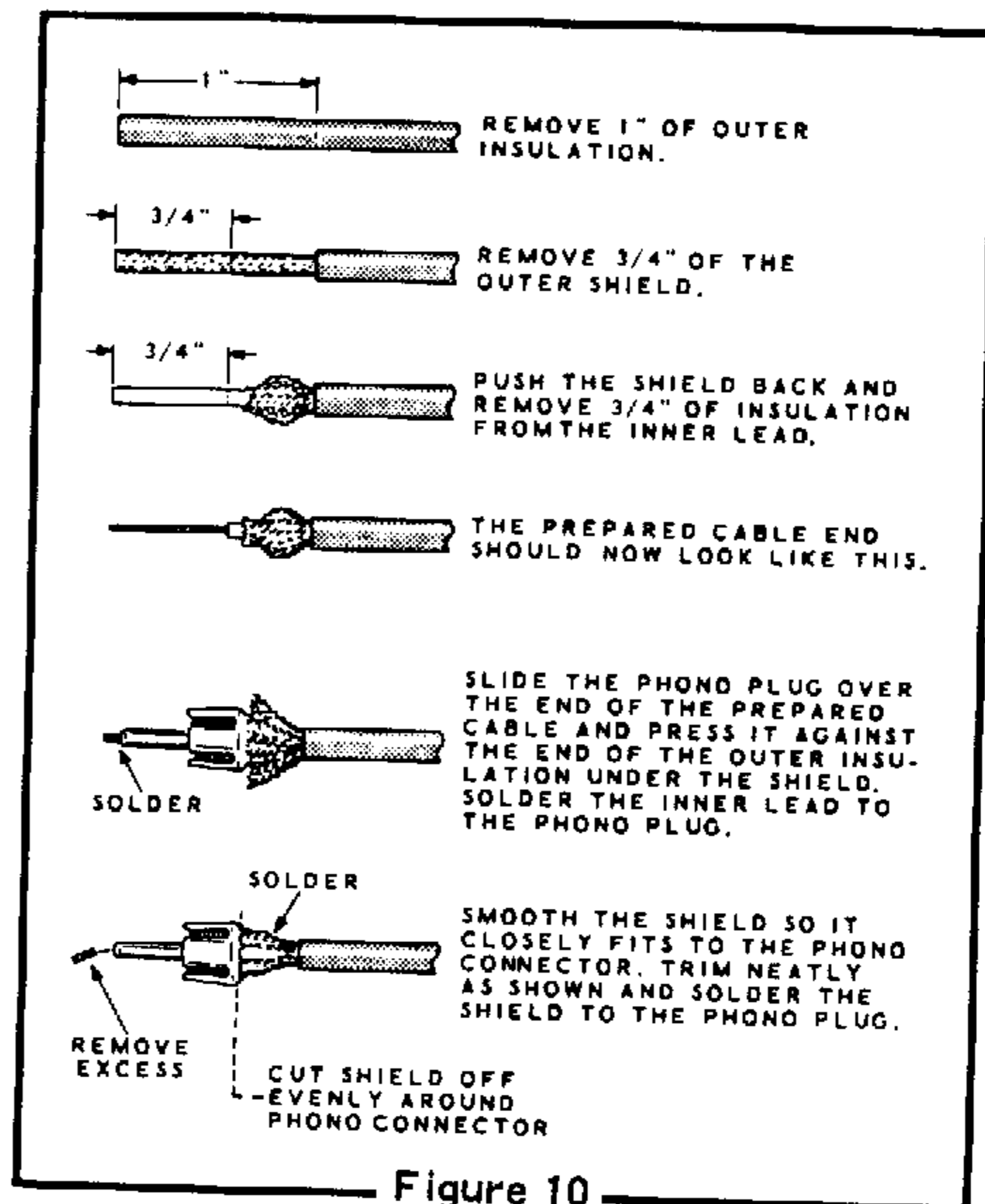

Figure 10

Attach a phono plug to one end of the length of coaxial cable as shown in Figure 10. NOTE: RG-62 cable (Heath #343-5) is supplied in your kit. Use only this type of cable.

- () Connect the other end of the coaxial cable, through one of the coupling capacitors, to the last IF stage of the receiver. NOTE: Use the smallest value of coupling capacitor that will give between 1/2" and 1" of pattern height on the Scope. The typical values are: 12 $\mu\mu\text{f}$ for RTTY and frequencies to 1000 kc; 2.2 $\mu\mu\text{f}$ for frequencies from 1600 to 2475 kc; and 1 $\mu\mu\text{f}$ for frequencies above 3000 kc. If more capacitance is needed for adequate pattern height, there may be a slight detuning of the receiver IF stage when the Vertical Gain control is turned. This detuning should not be critical unless too large a capacitance is used.

NOTE: If an auxiliary socket is available on the rear of the receiver, you may wish to connect the coupling capacitor from it to the last IF stage through an appropriate length of coaxial cable. In this case, also attach a plug on the other end of the coaxial cable.

- () Connect the coaxial cable from the receiver to the VERT jack on the rear of the Scope.
- () Adjust the Scope's front panel controls as directed in the Initial Control Settings, and then readjust them for the desired display.
- () Tune the receiver dial to a steady signal. Use a calibrator signal if one is available.

NOTE: No further internal adjustments are made to the Scope for RTTY or for IF frequencies to 150 kc. For frequencies of 455 to 2475 kc, only plate coil L2 is adjusted. For frequencies of 3000 kc and above, both plate coil L2 and grid coil L1 are adjusted.

NOTE: When adjusting coils L1 and L2, refer to Figure 6 and adjust them from the bottom of the chassis to avoid the danger of contact with the high voltages that are present at the switches on the upper front panel.

- () For IF frequencies of 455 kc and above, adjust plate coil L2 (and grid coil L1 if used) to produce maximum display height on the screen.
- () Retune the receiver IF transformer, if necessary, and repeat the adjustment of L2 (and L1 if used) until there is no further increase in display height.

- () Decrease the VERTICAL GAIN and observe the display. If the height does not decrease when the VERTICAL GAIN control is turned counterclockwise, the vertical amplifier is oscillating. These oscillations can be caused by an excess of signal from the receiver (overcoupling).
- () If the previous step showed that oscillations are present, change the coupling capacitor to a lower value. With receiver IF frequencies above 3000 kc, it may also be necessary to connect the 15 K Ω (brown-green-orange) 1 watt resistor from lug 1 to lug 2 of coil L1.
- () Repeat the adjustments of L1, L2, and the receiver IF transformer.

Receiver Envelope Patterns (Figure 11)

With the receiver adjusted for normal operation on an average signal, the VERTICAL GAIN control should be adjusted to produce an envelope pattern 1" to 1-1/2" high.

Many of the transmitter patterns described later may also be observed as a received signal. Bear in mind the limitations described in the following paragraphs, and refer to the appropriate sample patterns for the type of signal received. See Figure 11.

The receiver can produce several distinct effects which can alter or reshape the incoming signal into a display quite different from that which was transmitted. The two most pronounced effects are produced by the presence of AVC, and by the narrow bandwidth employed in the newer receivers.

With the AVC on, as you observe a pulsing signal such as CW or sideband, the leading portion of the waveform may be displayed with considerably higher than normal amplitude. This leading portion will reduce in height as the AVC takes hold. This effect can most easily be seen by observing the difference between patterns 35 and 36 on Pages 46 and 47.

The same distortion may be noted when watching voice patterns that produce momentary flat-topping on sideband. This problem can be avoided if the receiver AVC is turned off and the RF gain is reduced sufficiently to prevent overload.

RECEIVER PATTERNS

RECEIVER BANDWIDTH

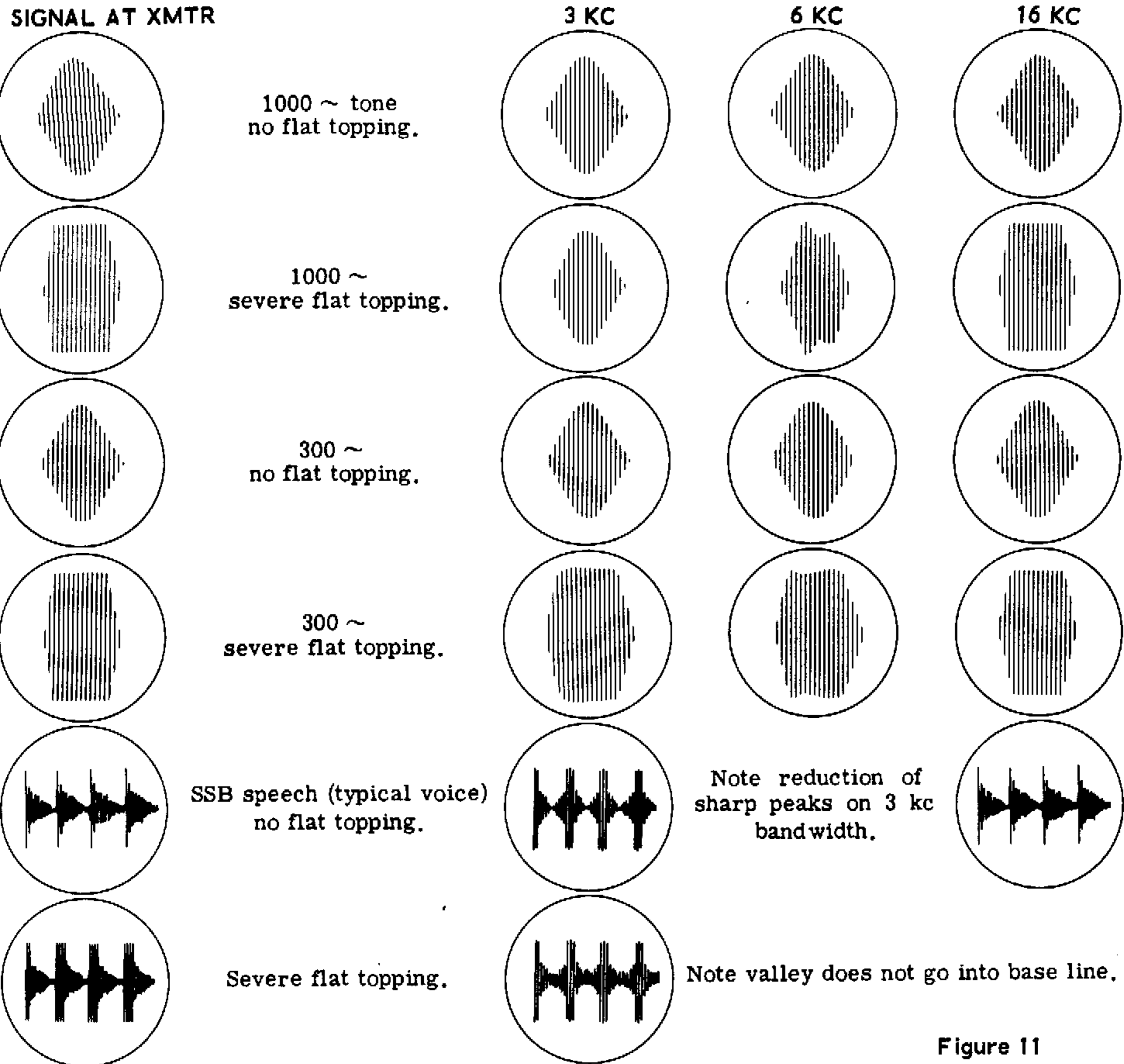

Figure 11

The bandwidth of the receiver IF determines the ability of the Scope to reproduce a display of the actual transmitted signal. Refer to the pattern sequence shown on Page 35. In order to obtain an undistorted display, the IF bandwidth must be roughly 10 times the modulating frequency. For example, a 3 kc bandwidth will pass a 300 cps square wave without distorting it, but a 1000 cps square wave would be shown as a somewhat distorted sine wave. Therefore SSB

signals that are "flat-topping" may appear acceptable on the RF envelope patterns.

A flat-topped signal can best be determined by observing the lack of peaks and valleys in the IF envelope pattern. See Figure 11. It is possible that the signal may be deliberately "shaped" by the use of premodulation clipping and filtering in the transmitter, to produce a pattern that may appear somewhat flat-topped.

TRANSMITTER MONITORING (Figure 12)

Most transmitters have 50-75 Ω coaxial outputs. The following instructions are written for this type of connection, with either a dummy load or an antenna. If the transmitter has other than a 50-75 Ω coaxial output, use a pickup antenna or a coaxial-coupled pickup link. Place it near the final RF amplifier tank coil and connect it to either one of the rear panel ANTENNA jacks of the Monitor Scope. With open wire or ribbon feed systems, use a length of wire placed close to one of the feeders.

Make sure a dummy load or antenna is connected each time the transmitter is operated, either through the Scope as in the case of coaxial feed, or directly where other antenna transmission line systems are used. When the Scope is used with the Heathkit HX-10 or HA-10 equipment, the full RF output should be connected through the Scope rather than using the special scope output on these units.

Refer to Figure 12 and connect the Transmitter, Scope, and antenna or dummy load as follows:

1. Connect the RF output of the transmitter or linear amplifier to either ANTENNA jack on the rear of the Scope.
2. Connect the dummy load or antenna to the other Scope ANTENNA jack.
3. Set the front panel controls as described in the Initial Control Settings section. Set the XMTR ATTEN switch fully clockwise.
4. Turn on the transmitter and adjust the XMTR ATTEN, HORIZ GAIN, and SWEEP FREQ controls for the desired pattern height and display.
5. Modulation of an AM or SSB transmitter may be checked by connecting a shielded cable from the TONE output jack of the Scope to the microphone input of the transmitter. If this is done, place the TONE GEN switch to the 1.5 kc position. A 2-tone position is also available for SSB checks and alignment. Voice modulation may be checked by using a microphone to voice modulate the transmitter.
6. Refer to the Transmit Envelope Patterns on Page 41 to evaluate the transmitter display.

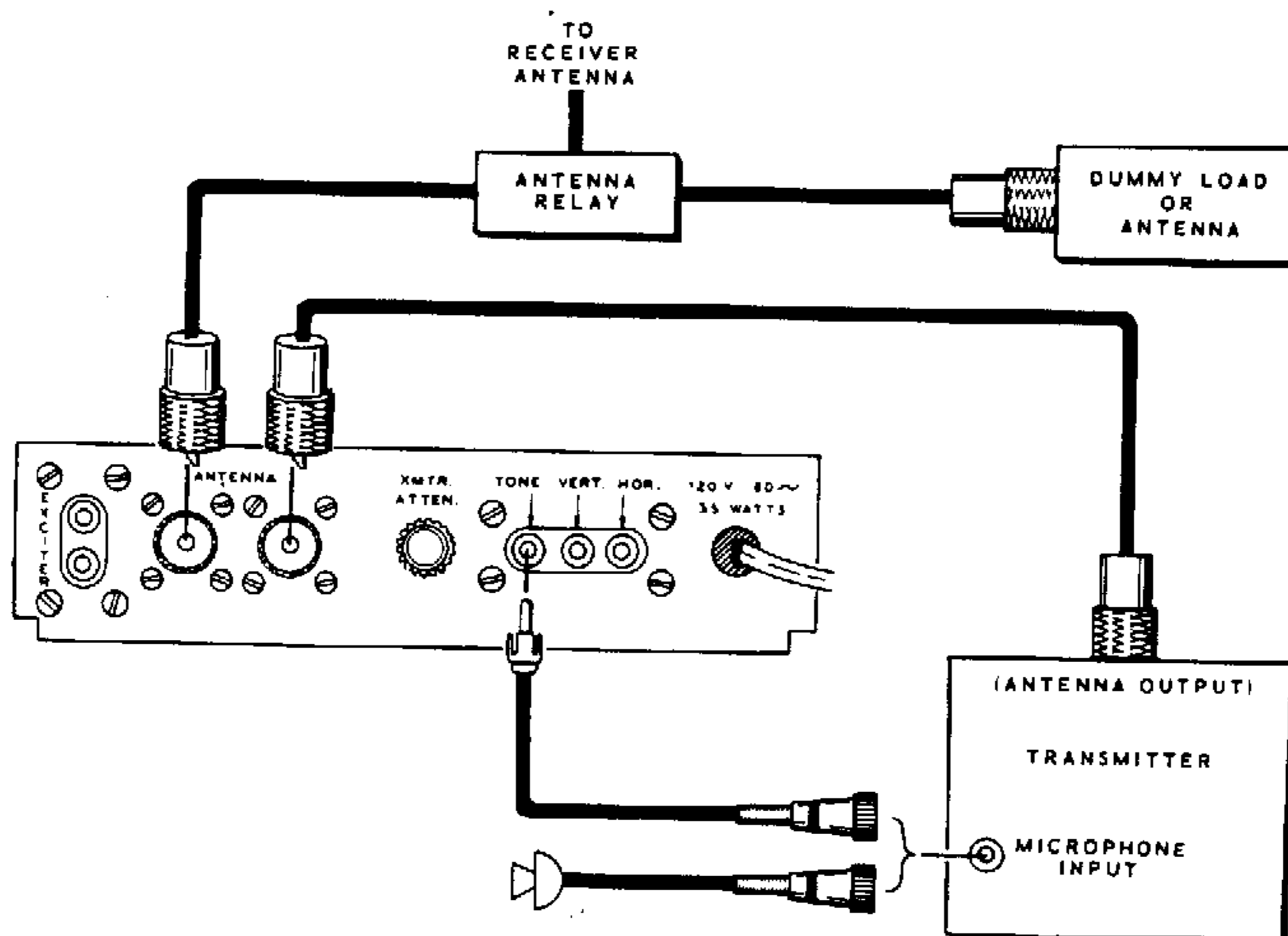

Figure 12

RF TRAPEZOID PATTERNS (Figure 13)

To check a linear amplifier for linearity, it is necessary to compare the exciter RF output with the RF output of the linear amplifier. The setup used for this purpose is shown in Figure 13.

1. Connect a coaxial cable from the RF output of the exciter to either EXCITER input jack of the Scope.
2. Connect a coaxial cable from the other EXCITER jack on the Scope to the input jack of the linear amplifier.
3. Connect a coaxial cable from the RF output of the linear amplifier to either ANTENNA jack of the Scope.
4. Connect the dummy load or antenna to the other ANTENNA jack on the Scope.
5. Connect a cable from the TONE jack of the Scope to the microphone input of the exciter.

6. Set all front panel controls on the Scope as directed in the Initial Control Settings section, but with the TONE GEN switch at the 2-TONE position and the SWEEP switch in the RF TRAP position.
7. Turn on the exciter and linear amplifier and adjust the Scope's XMTR ATTEN switch and HORIZ GAIN controls, and the transmitter's audio gain control for the desired display height pattern.
8. The trapezoid pattern that is shown on the Scope is obtained by comparing the RF output signal of the exciter with the amplified RF output of the linear amplifier. Refer to the Trapezoid Patterns on Page 44 and 45 for display analysis.

NOTE: The RF trapezoid pattern only indicates the linearity of the linear amplifier. This setup should not be used for general monitoring as it does not evaluate the exciter signal.

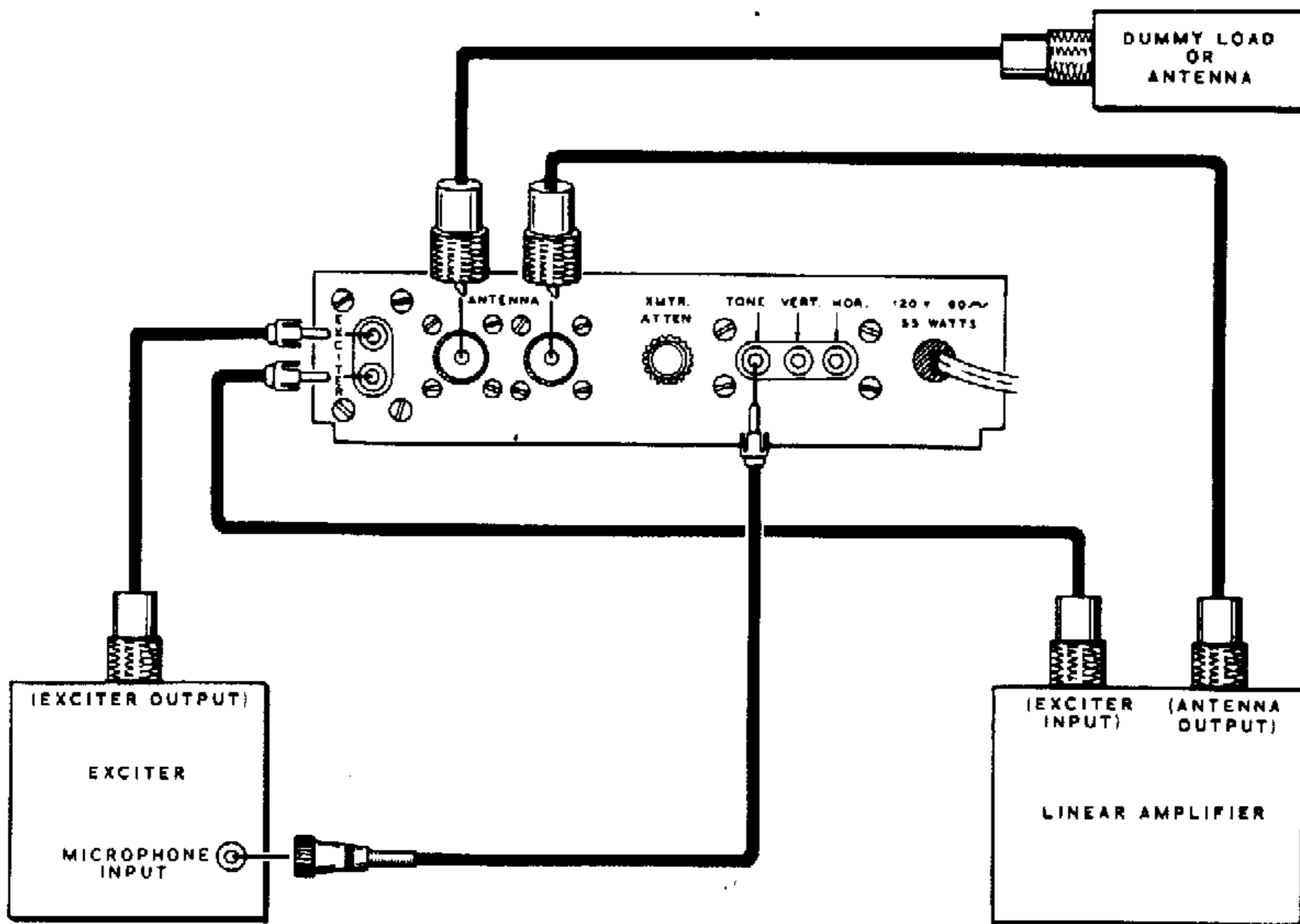

Figure 13

RTTY CROSS PATTERNS (Figure 14)

1. Connect a coaxial or shielded cable from the "mark" channel of the RTTY terminal unit to the HOR input jack of the Scope.
2. Connect a coaxial or shielded cable from the "space" channel of the RTTY terminal unit to the VERT input jack of the Scope.
3. Set the front panel controls as directed in the Initial Control Settings section.
4. Turn the terminal unit and Scope on, and place the scope SWEEP switch in the RTTY position with the Clamp switch pushed in.

NOTE: The "mark" and "space" outputs of the terminal unit should be adjusted to provide equal output voltages from the two channels when properly tuned in. This can be determined by alternately inserting the mark and space signals into the VERT input of the Scope and adjusting the terminal unit's balance control for equal height from both channels.

5. With the space channel connected to the VERT input and the mark channel connected to the HOR input, adjust the VERTICAL and HOR GAIN controls on the Scope to produce a cross pattern with equal height and width (about 1" x 1"). Once the desired size of the cross pattern has been set, the gain controls on the Scope should not be changed, as this will interact with the true setting of the balance control on the terminal unit.
6. Refer to RTTY Cross Patterns on Pages 45 and 46.

OSCILLOSCOPE USE (Figure 15)

The Monitor Scope can be used as a normal oscilloscope for limited test applications where internal sync, high sweep frequency, or high vertical amplifier gain are not required. To use the Monitor Scope as an oscilloscope, the vertical amplifier stage must be wired for "RTTY and 1 kc to 150 kc" in the Alternate Connections section (Page 24).

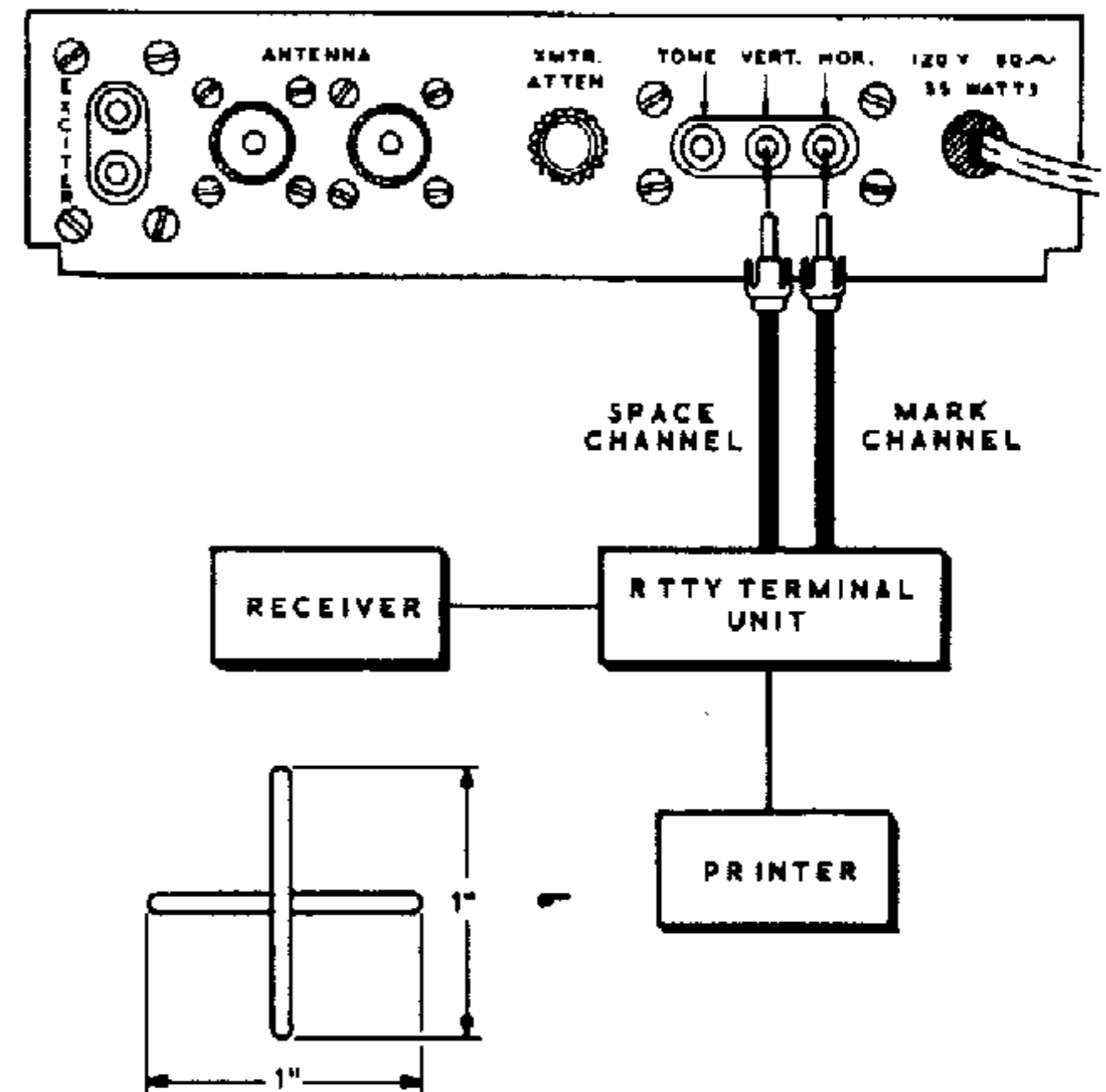

Figure 14

For most applications, the SWEEP switch will be set in the INT position to use the internal sawtooth generator for horizontal sweep. To use an external source for horizontal sweep, connect the horizontal signal to the HOR input, place the SWEEP switch in the RF TRAP position, and push the CLAMP switch in.

To use the Scope as an oscilloscope, connect the leads and adjust as follows (see Figure 15).

1. Connect a test lead to the VERT input jack, (Use a normal scope test probe.)
2. Connect a test lead to the HOR input jack.
3. Adjust the VERTICAL GAIN, HOR GAIN, and SWEEP FREQ controls for the desired pattern.

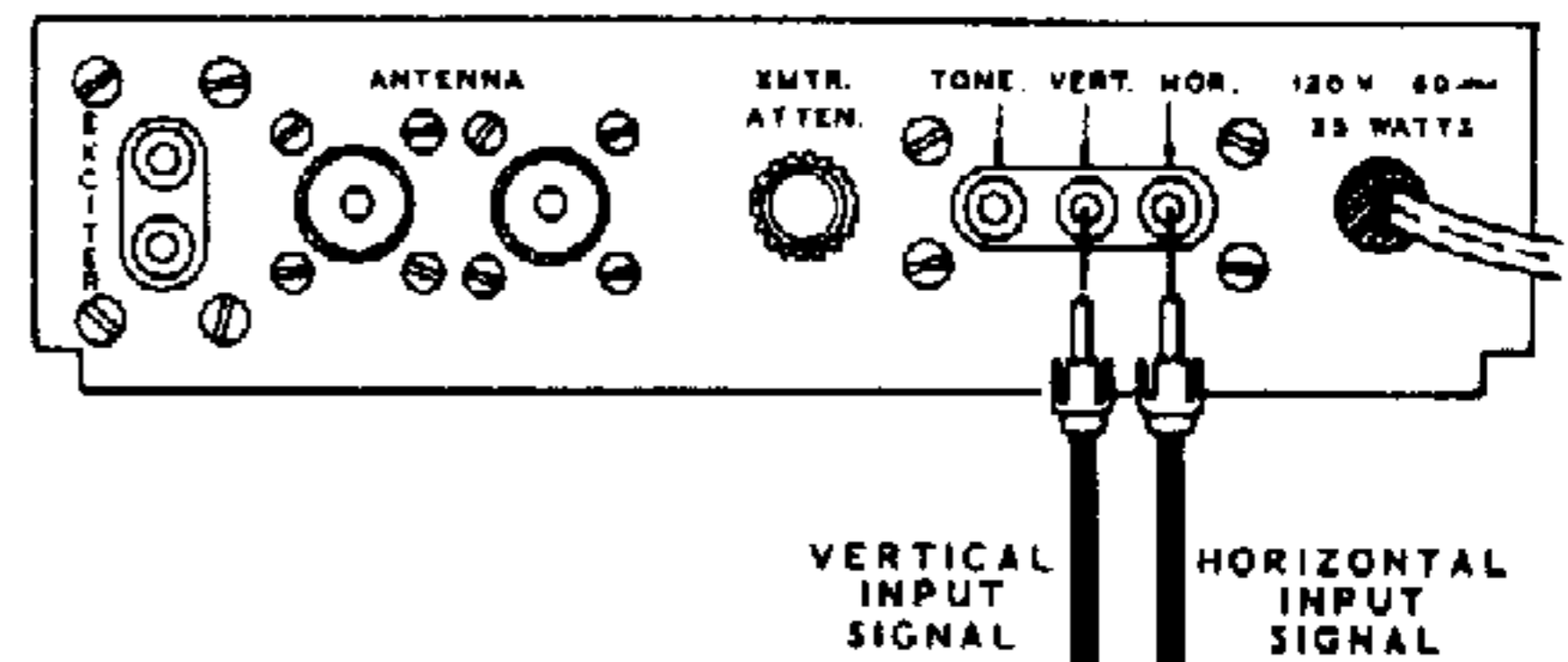

Figure 15

USE WITH CITIZEN'S BAND TRANSCEIVERS
(Figures 16 and 17)

The power output of a Citizen's Band transmitter is somewhat lower than the output of an amateur transmitter. To observe the transmit envelope patterns of a citizen's band transceiver, install a coil and capacitor as shown in Figure 16, and as shown in the Schematic diagram of Figure 17. These parts, coil #40-187 and capacitor #20-98, can be obtained from the Heath Company (see Page 14 of the Kit Builders Guide). The coil and capacitor are installed as follows:

- () Pass one lead of the capacitor through lug 2 (S-2) and lug 3 (S-2) of the coil, and fasten it to the solder lug at tube socket V3 (S-3).
- () Connect the other lead of the capacitor to lug 4 of the coil (NS).
- () Cut the heavy bare wire that goes from ANTENNA jack BC to lug 4 of switch BD. Leave about 1/2" connected at BC.
- () Connect the 1/2" bare wire from BC to lug 1 of the coil (S-1).
- () Connect the bare wire from lug 4 of switch BD to lug 4 of the coil (S-2).
- () Position the coil so it does not contact the chassis or other parts. The slotted adjustment screw should be easily accessible without danger of the screwdriver contacting the high voltage on the terminal strips next to tube V3.
- () Connect the Scope to the transceiver as shown in Figure 13 on Page 37.
- () Energize the transmitter and adjust the slotted screw in the end of the coil until maximum display height is obtained. Be careful not to touch any of the lugs on terminal strips D, E, F, or G, as there may be high voltage present.

CAUTION: With the Scope modified for CB use, do not attempt to monitor amateur transmitter signals. The coil and other parts in the Scope may be damaged if higher power transmitters are connected.

Proceed to Final Assembly to install the Scope in the cabinet.

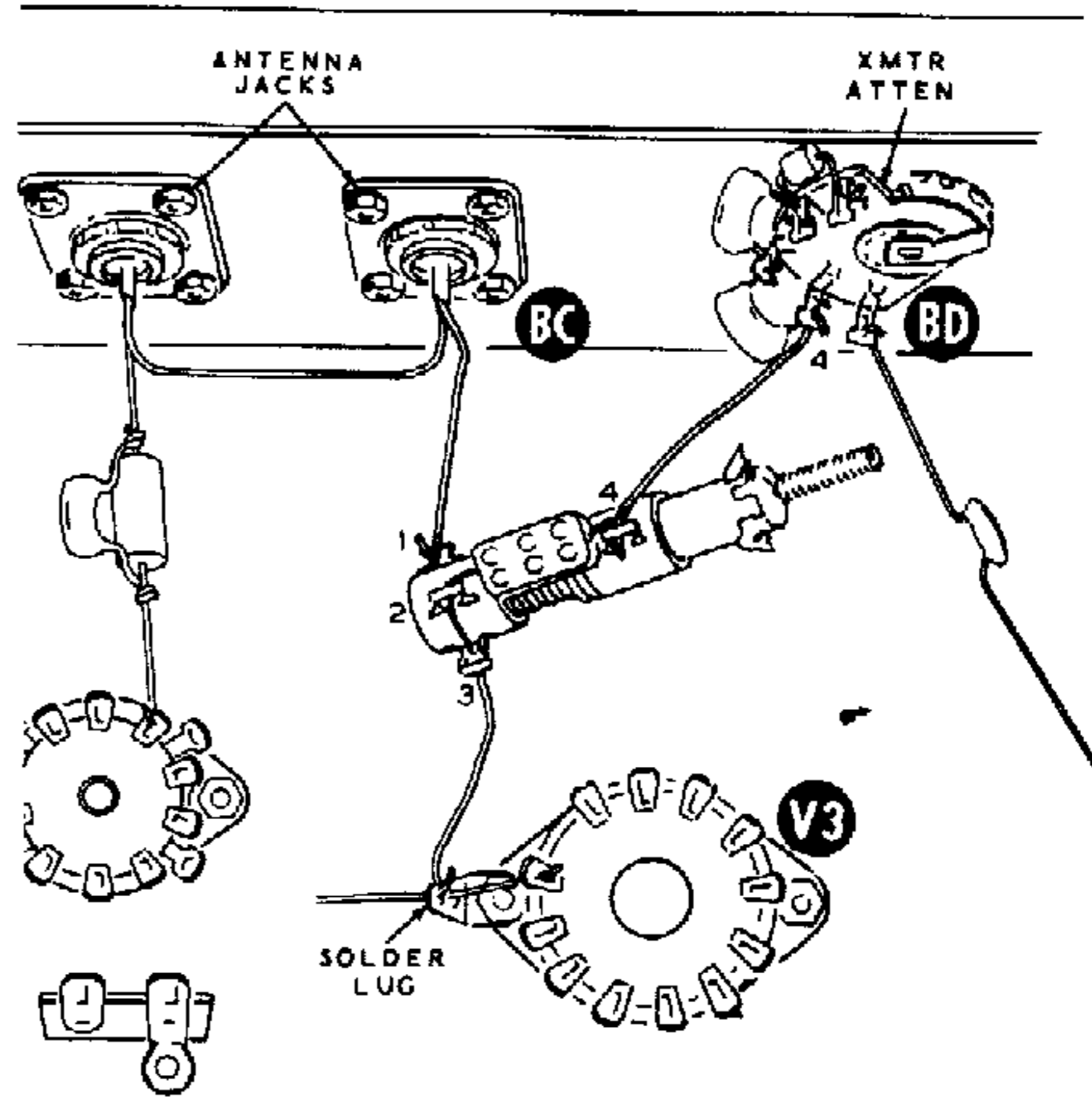

Figure 16

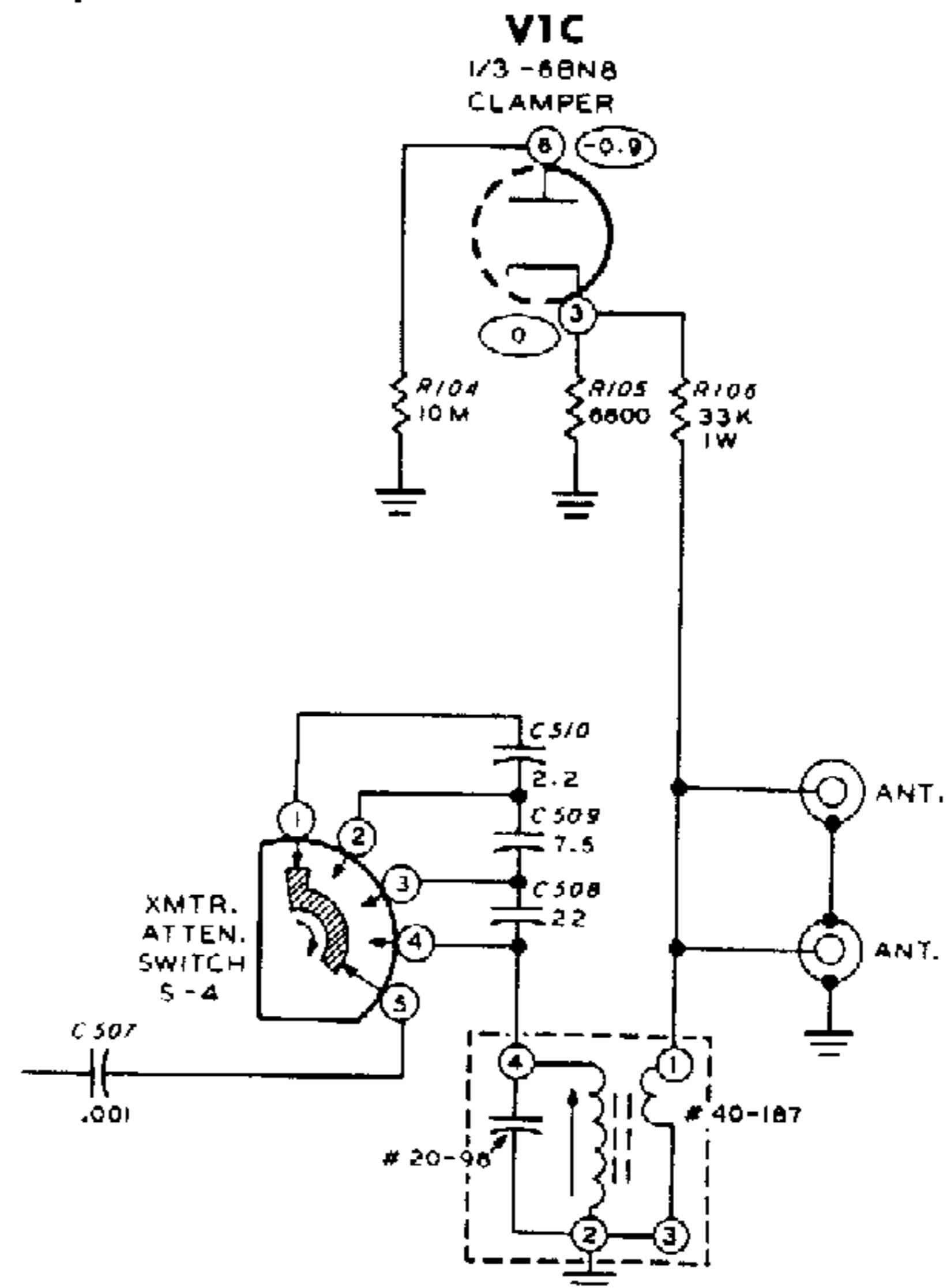

Figure 17

<u>PART No.</u>	<u>PARTS Per Kit</u>	<u>DESCRIPTION</u>	<u>PART No.</u>	<u>PARTS Per Kit</u>	<u>DESCRIPTION</u>
DIODES-TUBES-LAMP			HARDWARE		
(24) 56-26	1	1N191 Germanium diode (brown-white-brown)	Screws		
(25) 57-27	4	Silicon diode	(41) 250-49	12	3-48 x 1/4"
(26) 57-44	2	Selenium rectifier	(42) 250-56	19	6-32 x 1/4"
411-142	1	3RP1 CRT (cathode ray tube)	(43) 250-89	8	6-32 x 3/8"
411-128	1	6BN8 tube	(44) 250-250	4	6-32 x 1/2" (black)
411-167	1	6C10 compactron tube	(45) 250-29	4	6-32 x 3/4"
411-170	1	6EW6 tube	(46) 250-40	2	6-32 x 1-1/2"
411-168	1	6J11 compactron tube	(47) 250-33	1	6-32 x 1/8" setscrew
(27) 412-15	1	Neon lamp	(48) 250-43	9	8-32 x 1/4" setscrew
			(49) 250-137	4	8-32 x 3/8"
TERMINAL STRIPS			Nuts		
(28) 431-14	3	2-lug	(50) 252-1	12	3-48
(29) 431-2	1	2-lug	(51) 252-3	27	6-32
431-32	4	2-lug with #8 hole	(52) 252-4	4	8-32
(30) 431-12	3	Small 4-lug	(53) 252-7	12	Control nut
(31) 431-44	1	Large 4-lug	(54) 252-10	2	Small speednut
(32) 431-42	5	5-lug	(55) 252-9	1	Large speednut
SOCKETS-PLUGS			Washers		
(33) 434-34	1	7-pin tube socket	(56) 254-7	13	#3 lockwasher
(34) 434-56	1	9-pin tube socket	(57) 254-1	44	#6 lockwasher
(35) 434-121	2	12-pin tube socket	(58) 254-2	8	#8 lockwasher
(36) 434-159	1	12-pin CRT socket with leads	(59) 254-5	5	Small control lockwasher
(37) 434-82	1	Double phono socket	(60) 254-4	2	Large control lockwasher
(38) 434-76	1	Triple phono socket	(61) 253-60	4	#6 flat washer
(39) 436-5	2	Coaxial socket	(62) 253-10	10	Flat control washer
(40) 438-4	5	Phono plug	Other Hardware		
			(63) 259-1	3	#6 solder lug
			(64) 259-6	2	#6 small solder lug
			(65) 259-10	2	Control solder lug
			(66) 255-55	1	3/4" tapped spacer
			(67) 255-63	2	2" tapped spacer

TRANSMIT ENVELOPE PATTERNS

SSB signal, voice input, correctly adjusted.

①

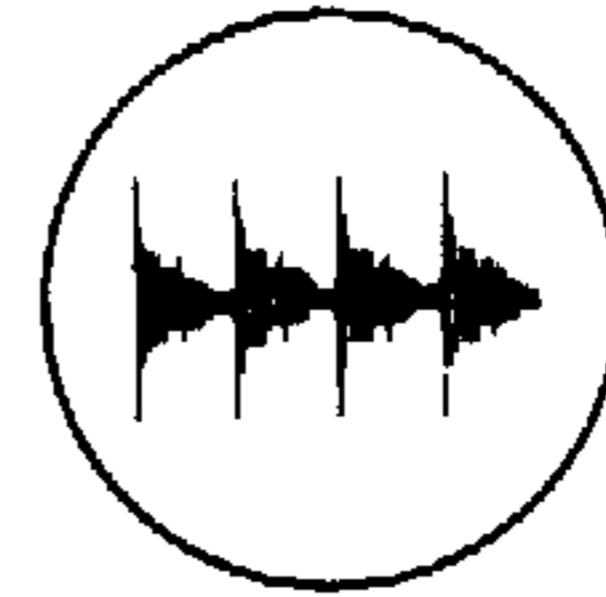

SSB signal, voice input, slightly excessive speech gain, or insufficient amplifier loading.

②

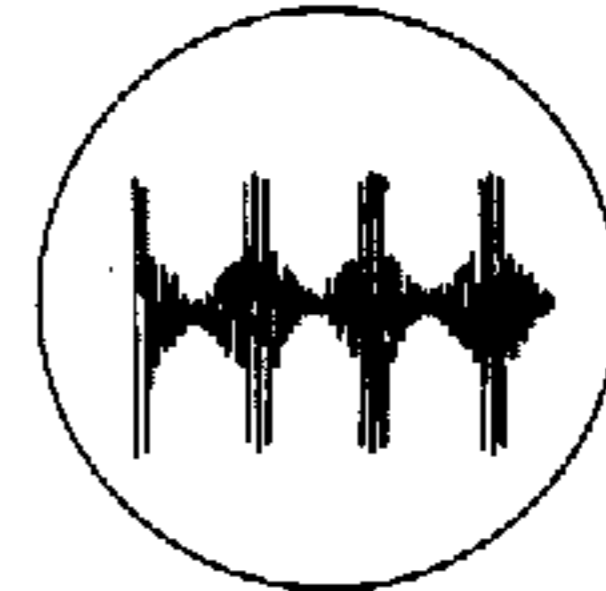

Pure CW carrier or perfect single tone input on SSB. May also occur on single tone SSB with excessive drive which results in amplifier "flat-topping." Note absence of fine ripple.

③

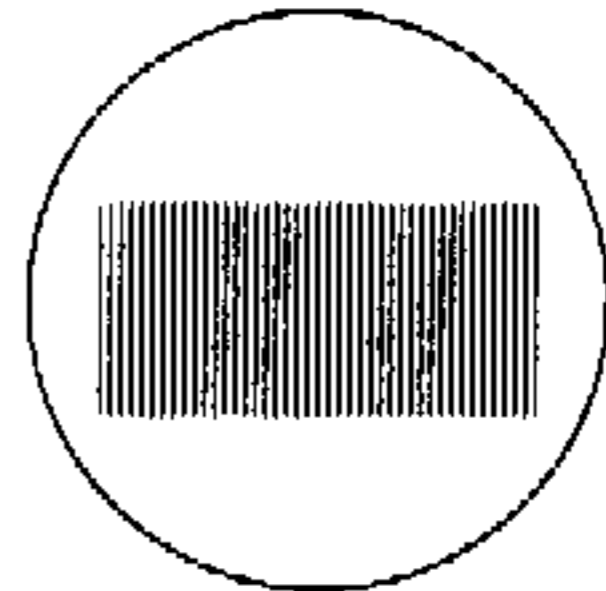

SSB signal, single tone input, sideband suppression down approximately 40 db or CW signal with spurious radiation down approximately 40 db.

④

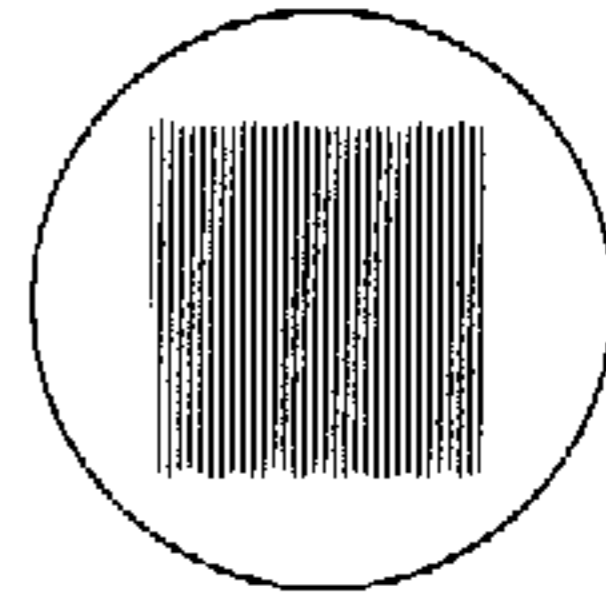

Same as 4 except down approximately 20 db. In SSB, the poor suppression may be due to audio unbalance or improper RF phase shift.

⑤

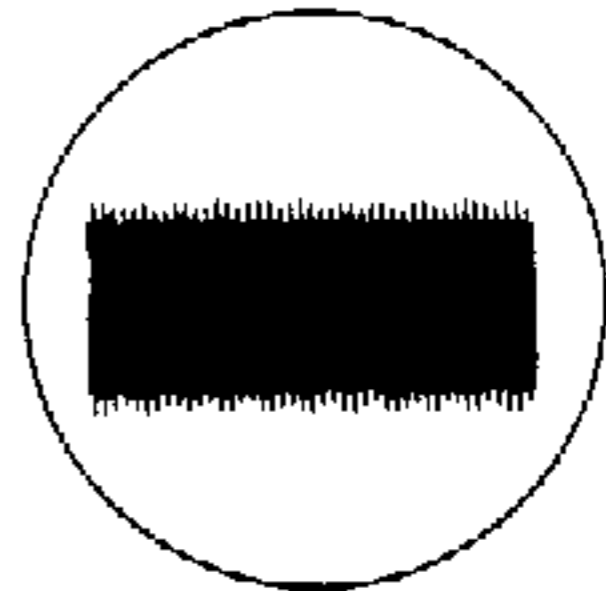

Same as 4, down approximately 10 db.

⑥

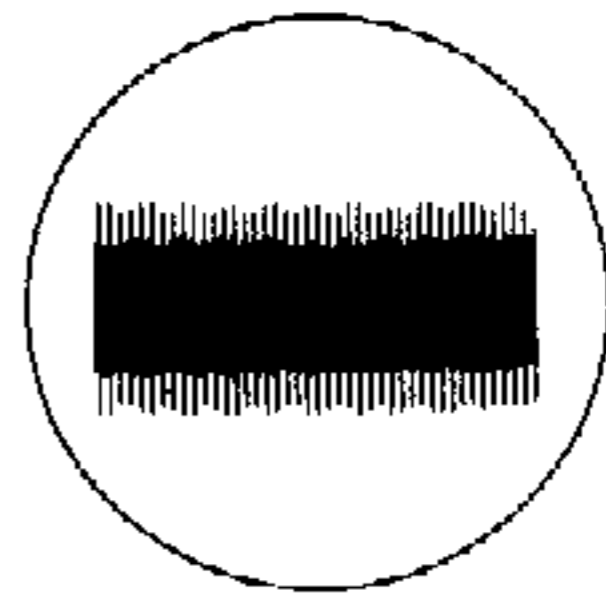

SSB signal, single tone input with carrier leakage. This pattern will have half the number of ripples due to poor sideband suppression. (See waveform 5.)

7

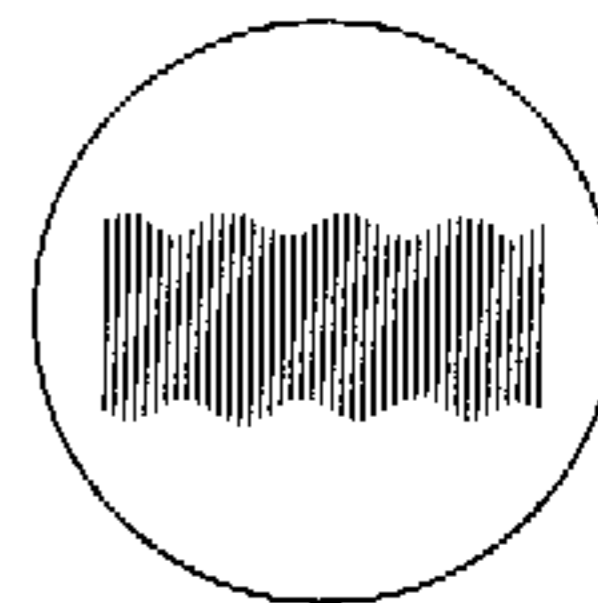

SSB signal, single tone input. Distortion in audio oscillator or audio system, balanced modulator detuned, or insufficient RF in balanced modulator.

8

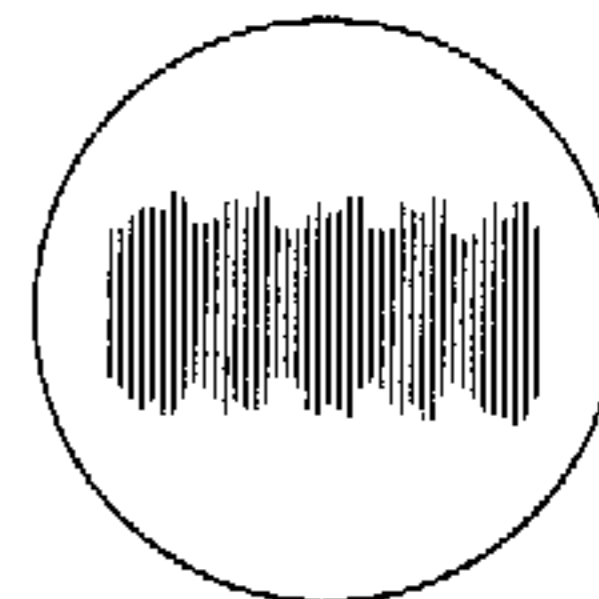

SSB signal, single tone input. Very little sideband suppression. Caused by defective modulator tube; audio phase shift network; 90 degrees RF phase shift component; partially shorted modulation transformer; secondary of transformer that feeds audio phase shift network shorted to ground; crystal oscillating on two adjacent frequencies simultaneously or both heterodyne oscillators on together.

9

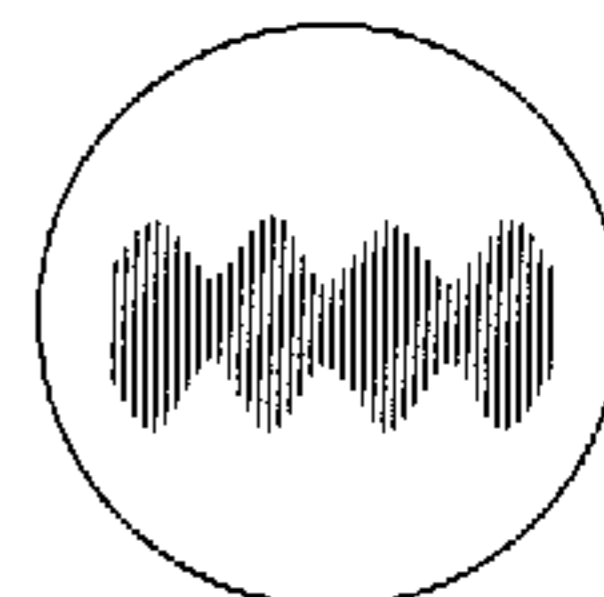

Normal double sideband, single tone input.

SSB signal, single tone input with no sideband suppression. May be due to one modulator tube dead, modulation transformer open or shorted, defective bandpass filter.

10

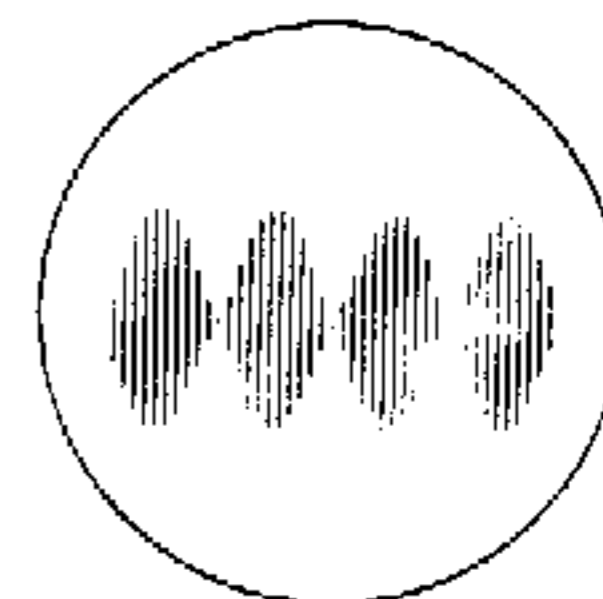

Normal SSB signal, 2-tone input, tones properly adjusted for equal amplitude.

SSB with carrier, single tone input. Incorrect value of carrier or modulation. Excessively rounded tops would indicate too much carrier.

11

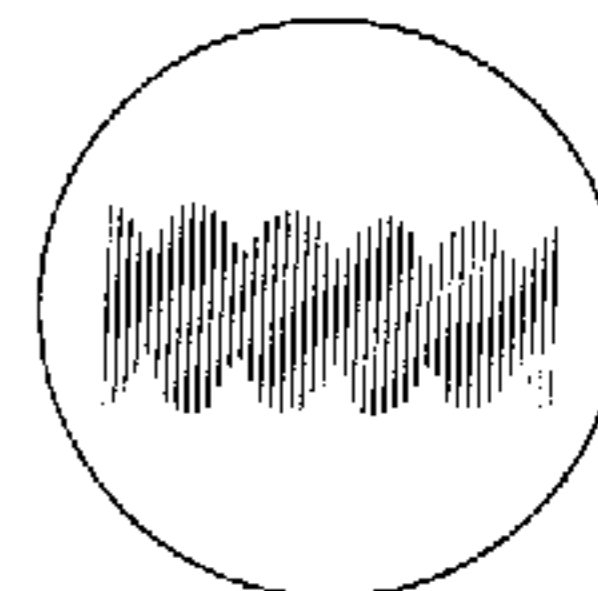
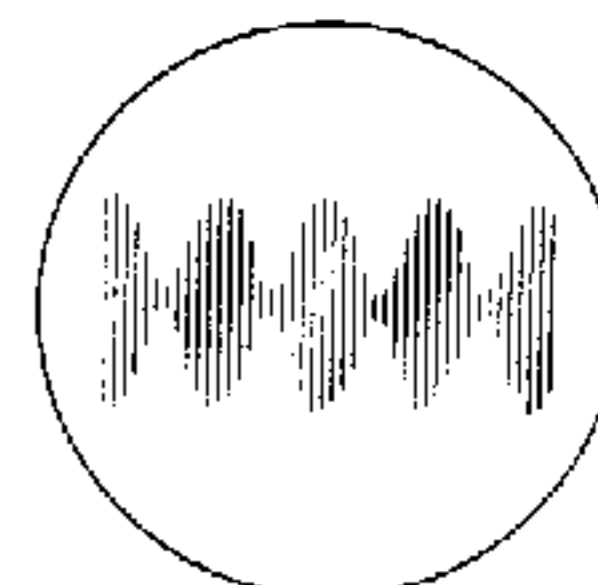

Plate modulated AM, or double sideband with carrier inserted, single tone input. Nearly 100% modulated. Excellent waveform.

12



Double sideband with carrier inserted (low level AM), single tone input. Too much carrier inserted. Note that the positive peaks flatten before a fine base line is obtained. Peak flattening may also be caused by insufficient antenna loading, insufficient interstage loading, an overdriven linear amplifier, poor dynamic power supply regulation, etc.

13

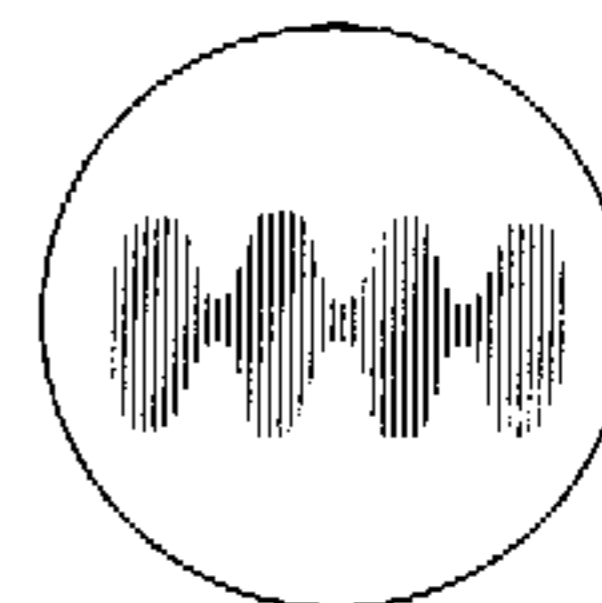

Double sideband with carrier inserted (low level AM), single tone input. Insufficient carrier insertion or excessive audio, resulting in high distortion (overmodulated). Also called Double Sideband Reduced Carrier (DSRC).

14

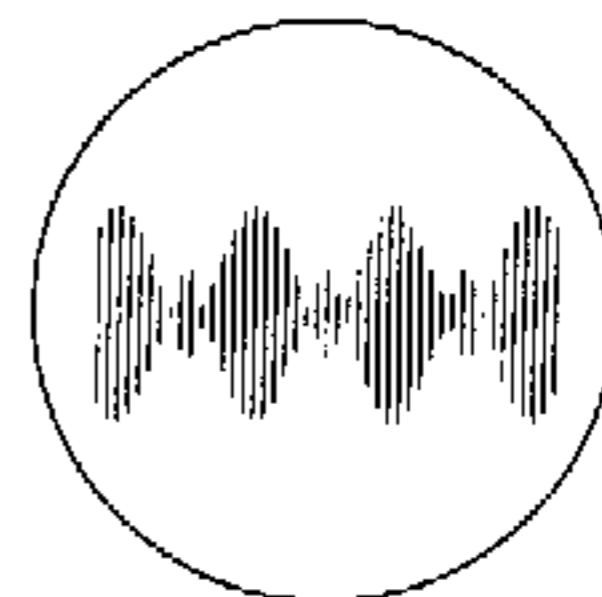

Low or high level AM with strong parasitics appearing on modulation peaks. Very fine, "Grassy" appearance on peaks would indicate parasitic in the UHF range.

15

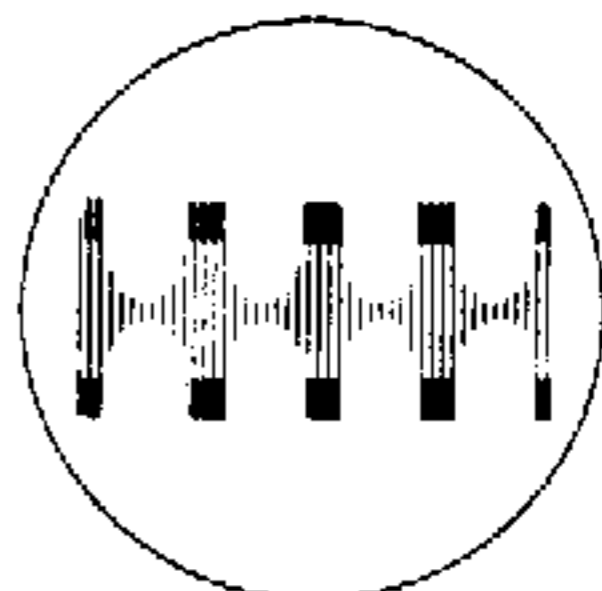

SSB, 2-tone input, or double sideband, single tone input; carrier leakage in either causes uneven height of successive half cycles of modulation envelope.

17

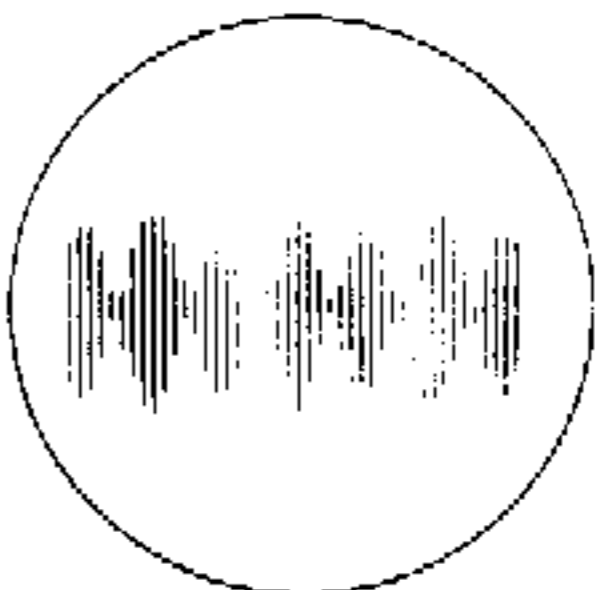

Low or high level AM, single tone input. Severe distortion in modulator system or AF tone generator, RF feedback to audio system, or RF feedback to previous low level stage.

18

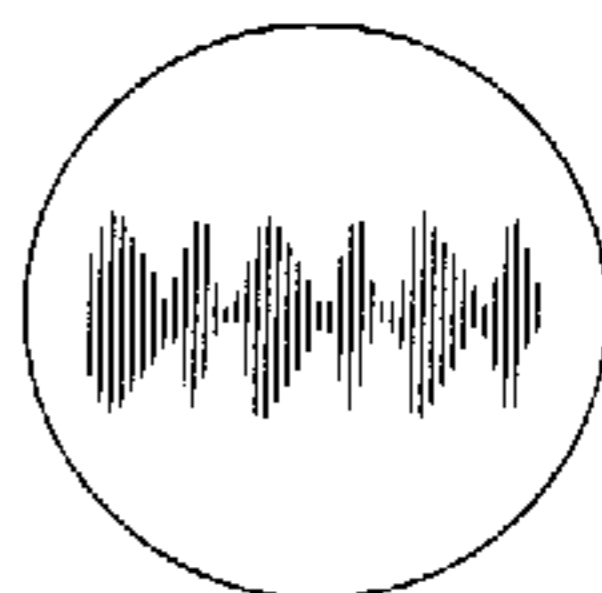

Nonlinearity in modulated RF stage, single tone input, due to insufficient excitation of a plate modulated stage, overdrive to a grid modulated stage, or insufficient antenna loading of a grid modulated stage.

19

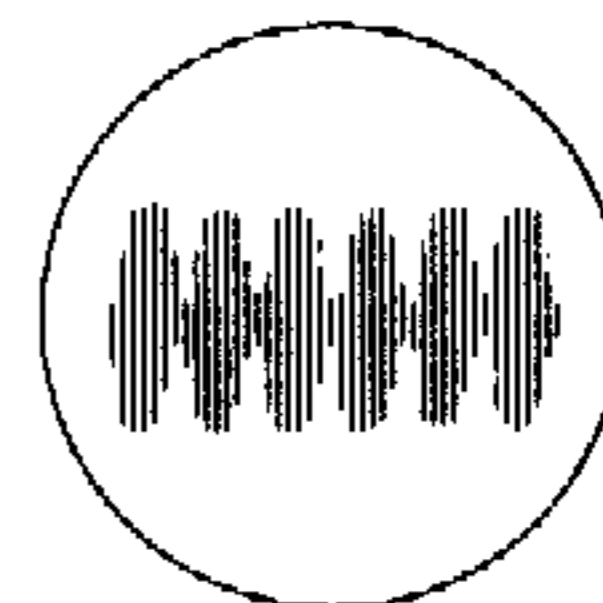

Plate modulated AM, single tone input. Overdriven modulator incapable of 100% modulation. May also result from deliberately clipped audio not properly filtered.

20

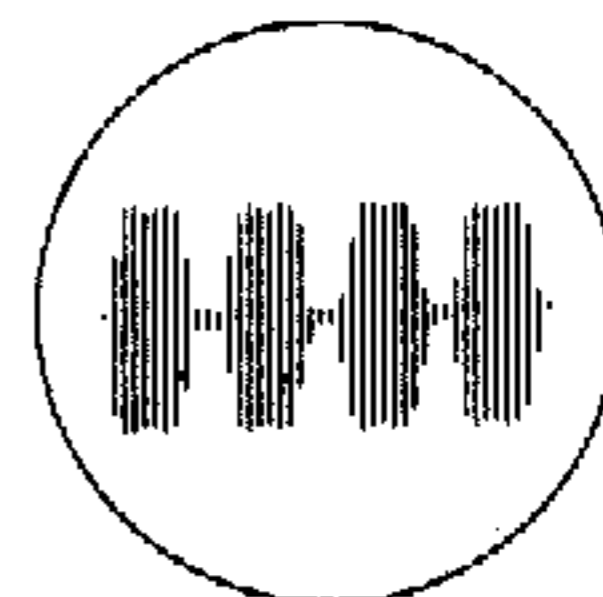
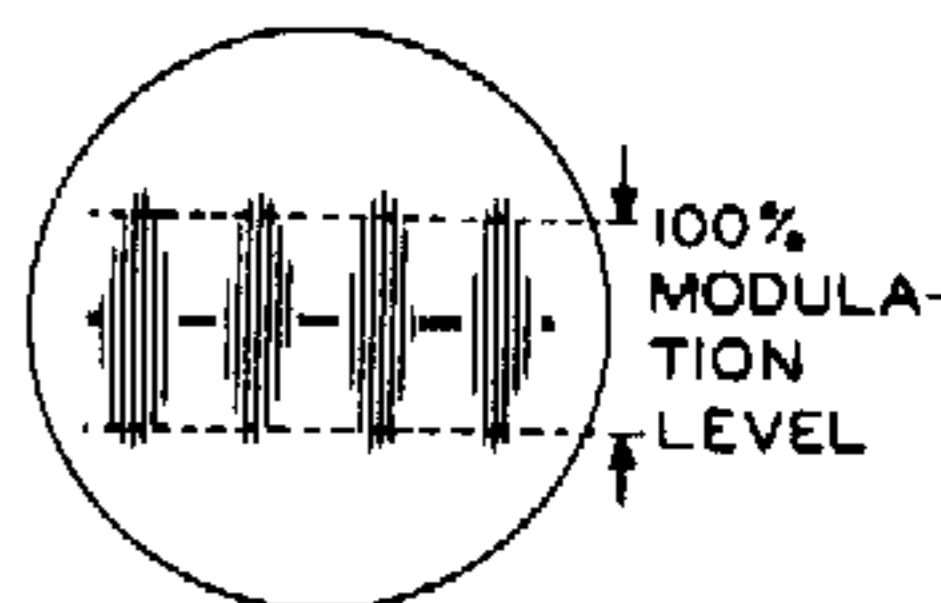

Plate modulated AM, single tone input. Modulator output more than ample. Modulation in excess of 100% in both directions.

21



TRAPEZOID PATTERNS

RF trapezoid. Good linearity. Desirable pattern.

22

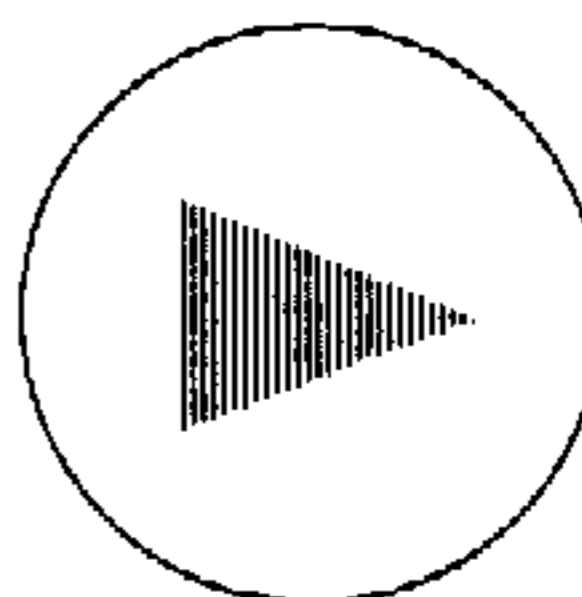

Modulation less than 100%. No distortion.

23

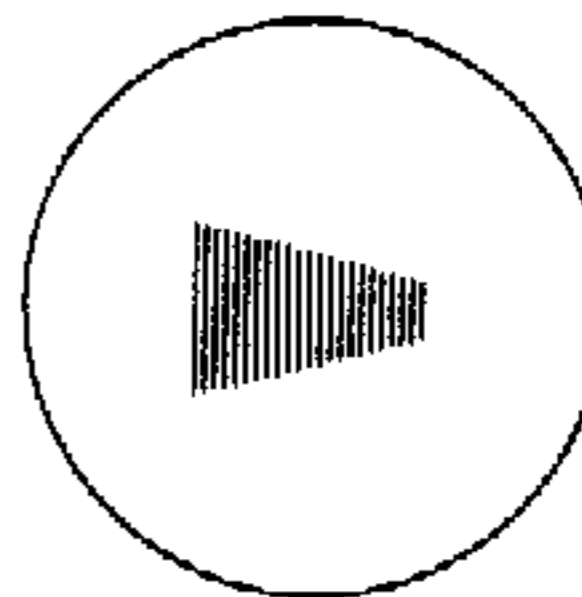

Nonlinear. With RF trapezoid through linear amplifier; indicates overdrive, insufficient antenna loading, grid current curvature, or regeneration.

24

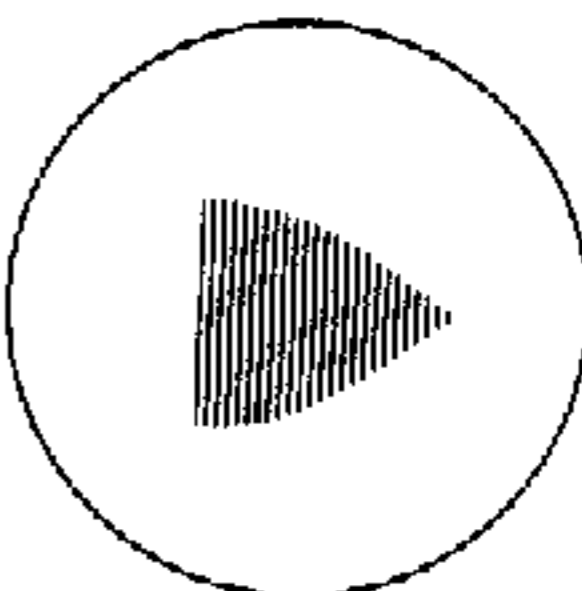

Nonlinear. In linear operation this also indicates regeneration, or excessive grid bias.

25

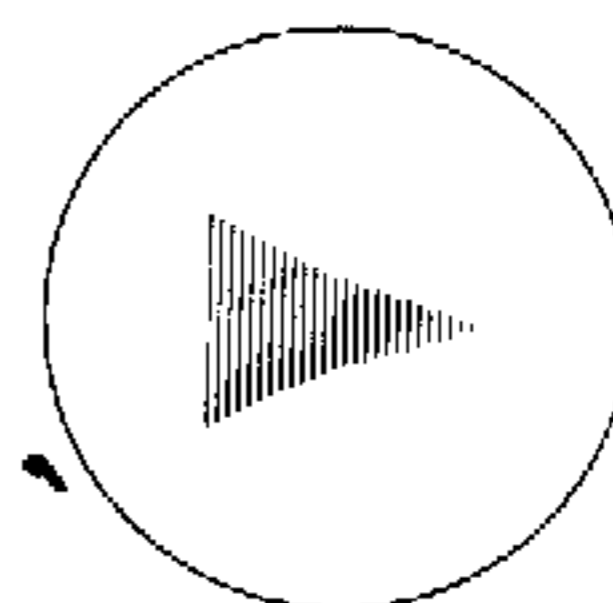

Parasitics occurring on modulation peaks.

26

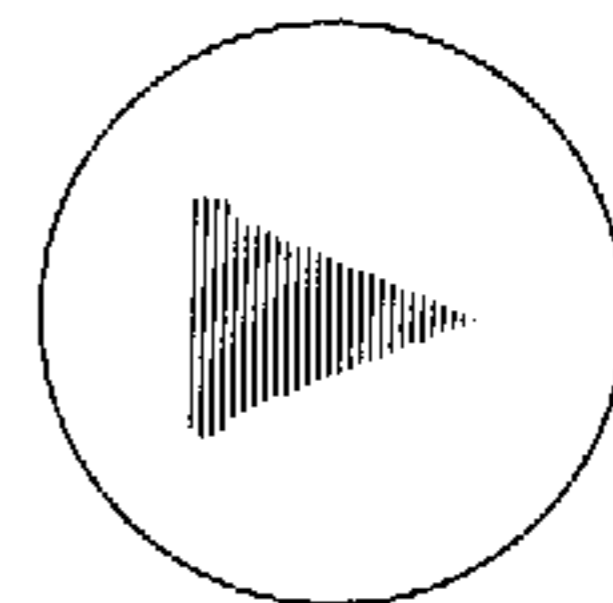

Grid modulation with improper neutralization and reactive load.

27

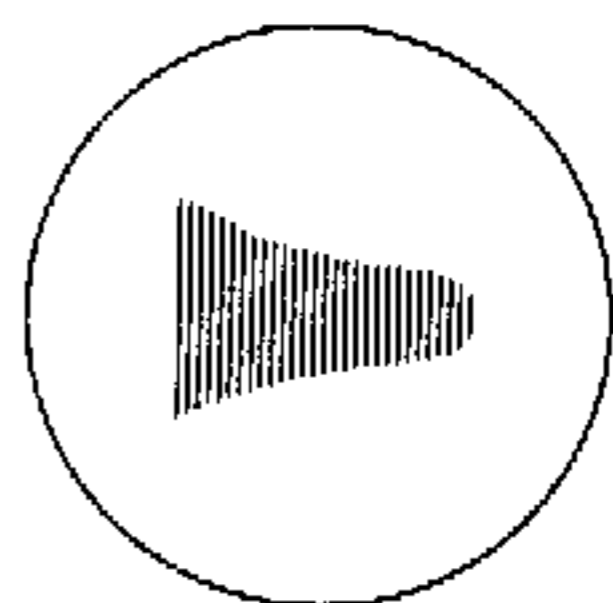

Unmodulated carrier. Can be caused by:
No signal at horizontal deflection plates,
Tone test oscillator inoperative,
Gain control turned off on transmitter or oscilloscope,
Audio failure in transmitter.

28

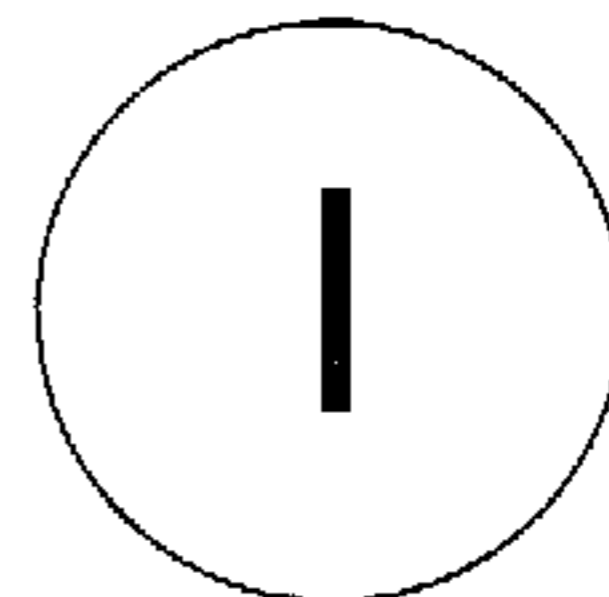

RTTY CROSS PATTERNS

Mark only. The relative narrowness of the ellipse provides good indication of the channel separation capability in the terminal unit.

29

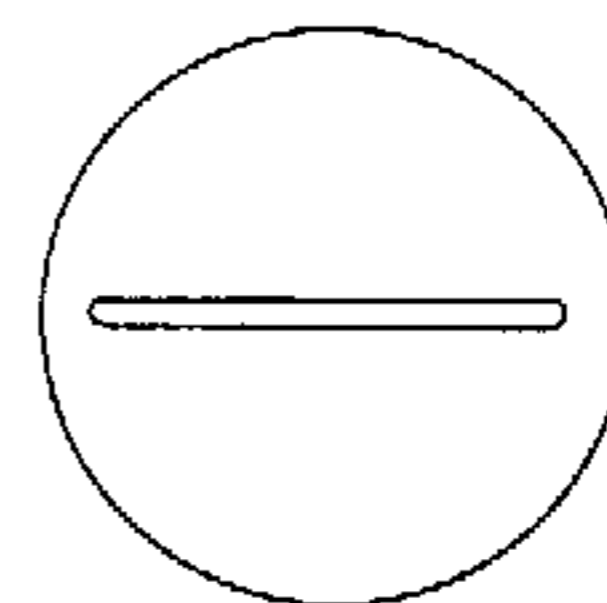

Space only. The relative narrowness of the ellipse provides good indication of the channel separation capability in the terminal unit.

30

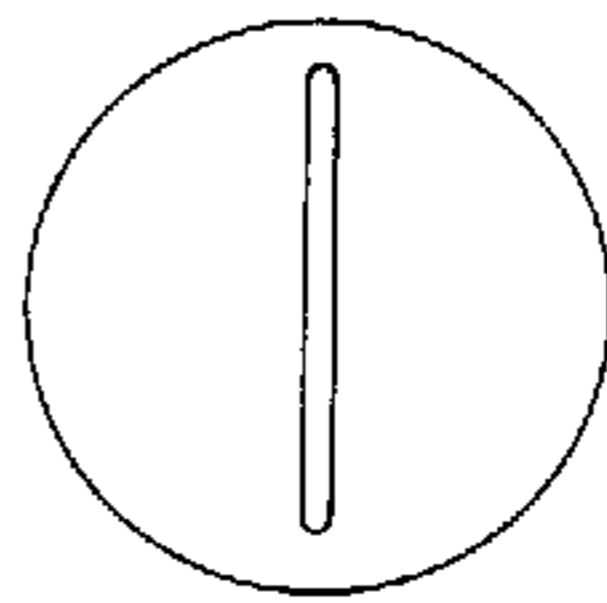

RTTY signal, proper shift, correctly tuned in.

31

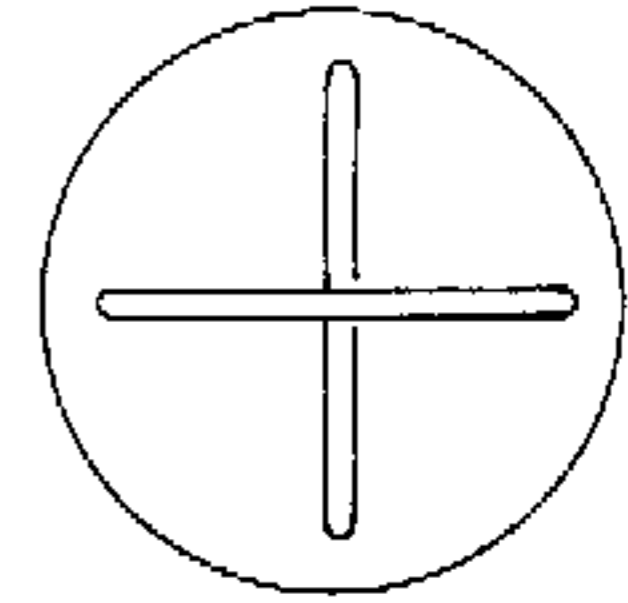

Incorrect shift, space tuned in, or selective fading.

32

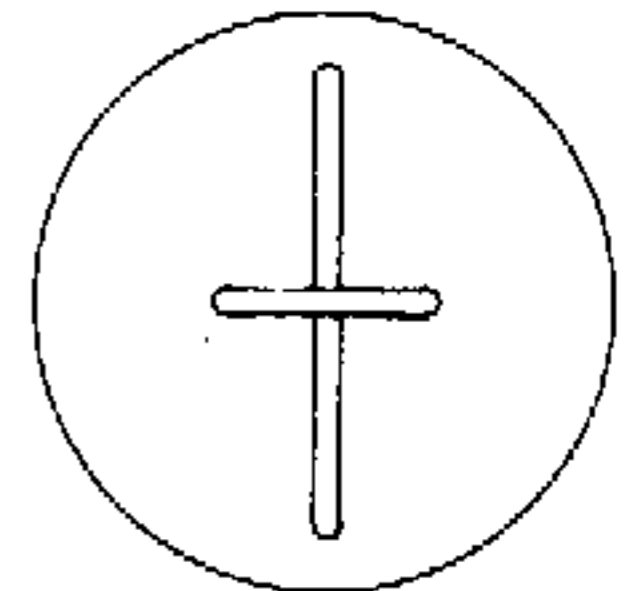

Incorrect shift, mark tuned in, or selective fading.

33

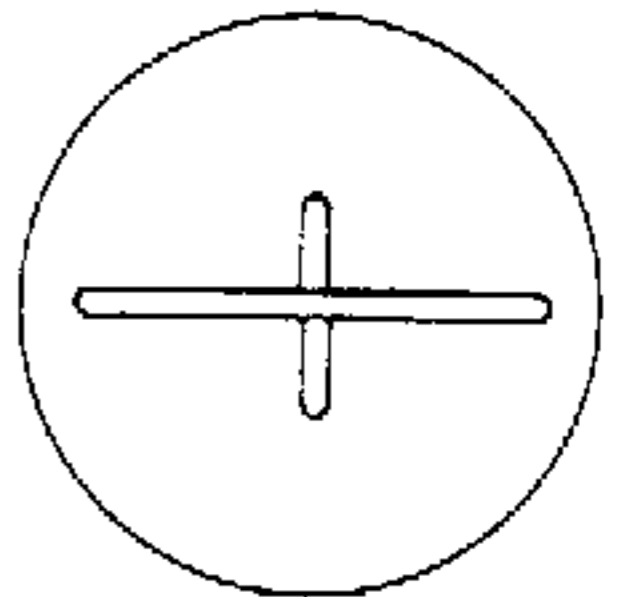

"Straddle" tuning of incorrect shift.

34

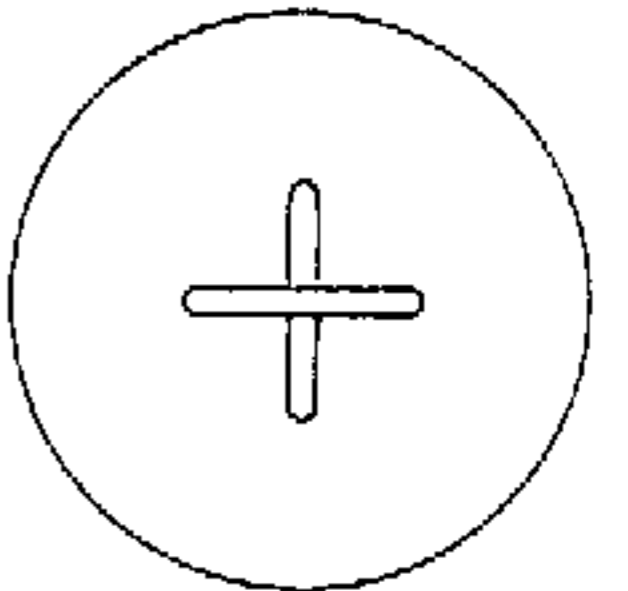

CW PATTERNS

Good CW pattern, properly shaped keying, string of dots. Pattern can be approximately locked using automatic keyer or bug.

35

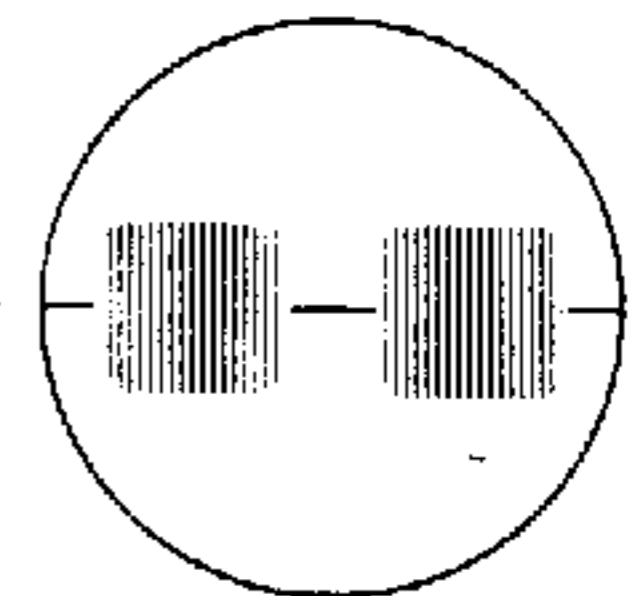

CW pattern showing effect of receiver AVC action or poor power supply regulation in the transmitter.

36

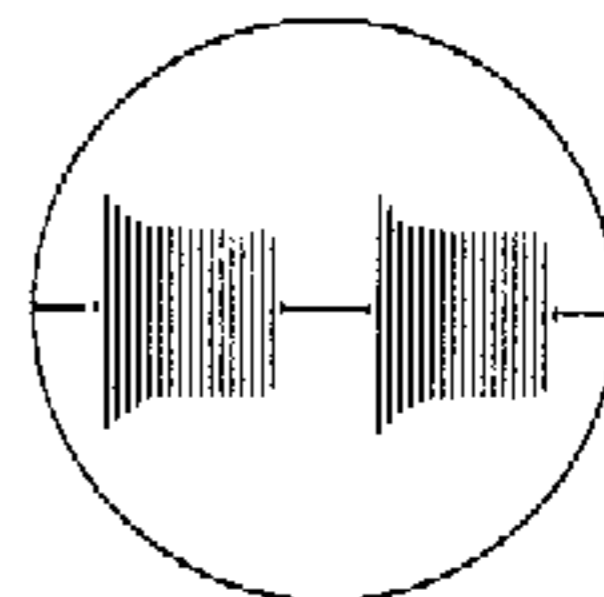

CW pattern, mild key clicks.

37

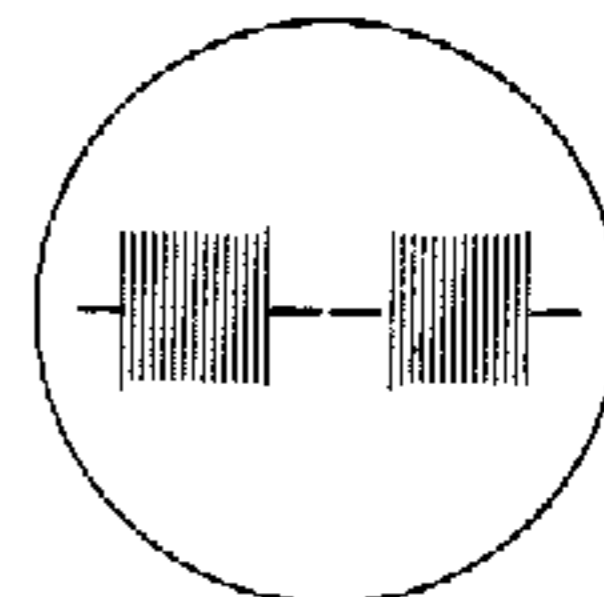

CW pattern, severe key clicks.

38

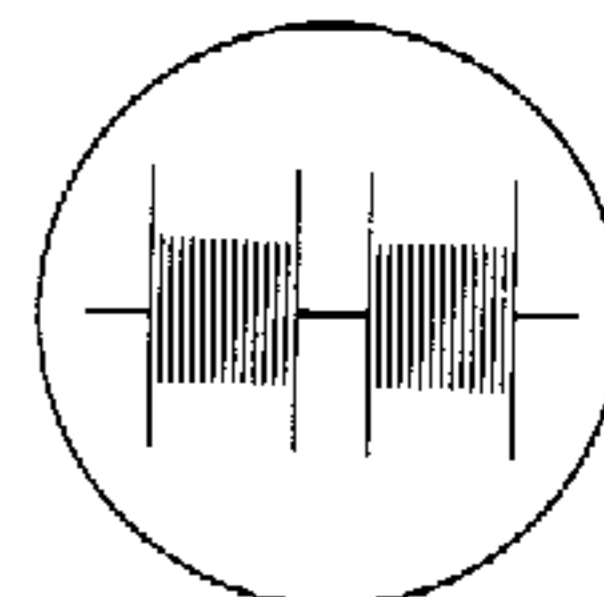

CW pattern with considerable backwave, RTTY transmitter pattern with unequal mark and space outputs, or RTTY receiver pattern with signal not properly centered in IF bandpass, or bandpass too narrow.

39

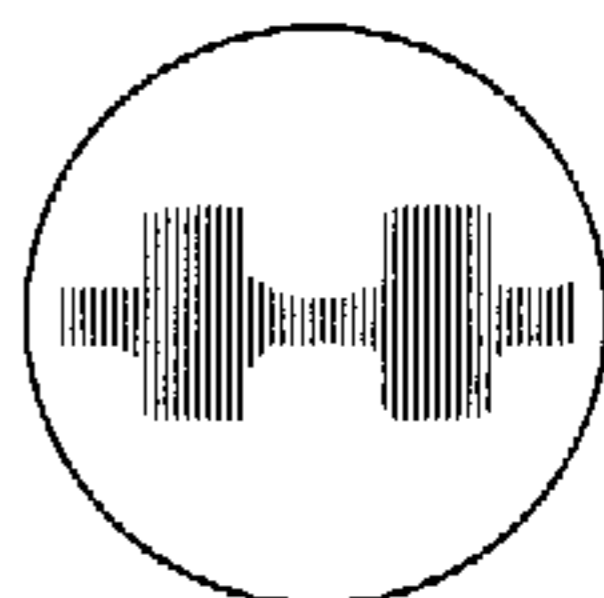

CW pattern, string of dots indicating poor contacts or contact bounce in keying mechanism.

40

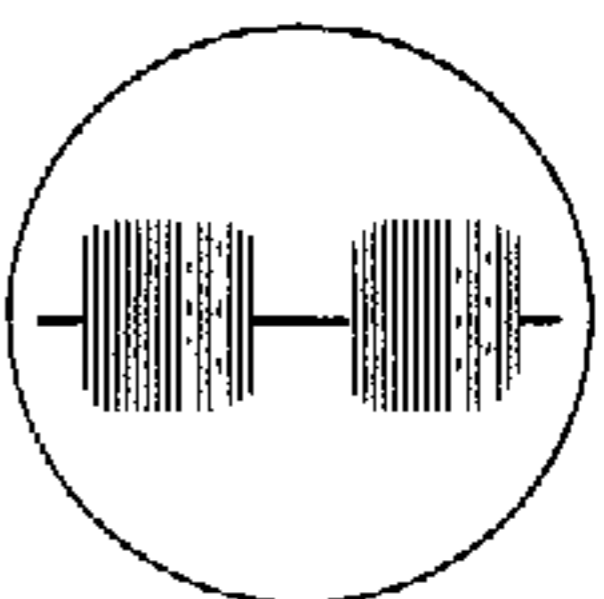

IN CASE OF DIFFICULTY

1. Recheck the wiring. Trace each lead in colored pencil on the Pictorial as it is checked. Have a friend check your work. Someone who is not familiar with the unit may notice something that is overlooked by the constructor.
2. About 90% of the kits that are returned for repair do not function properly due to poor connections and soldering. Therefore, many troubles can be eliminated by reheating all connections to make sure that they are soldered as described in the Soldering section of the Kit Builders Guide.
3. Check to be sure that all tubes are in their proper locations. Make sure that all tubes light up properly.
4. Check the tubes with a tube tester, or by substitution of tubes of the same types that are known to be good.
5. Check the values of the parts. Be sure that the proper part has been wired into the circuit, as shown in the pictorial diagrams and as called out in the wiring instructions.
6. Check for bits of solder, wire ends or other foreign matter which may be lodged in the wiring.
7. If, after careful checks, the trouble is still not located and a voltmeter is available, check voltage readings against those shown on the Schematic Diagram. Note: All voltage readings were taken with an 11 megohm input vacuum tube voltmeter. Voltages may vary as much as 10%.
8. A review of the Circuit Description will help indicate where to look for the trouble.
9. Refer to the Troubleshooting Chart for further help in locating causes of trouble.

NOTE: In an extreme case where you are unable to resolve a difficulty, refer to the "Customer Service" information inside the rear cover of the Manual. Your Warranty is inside the front cover.

TROUBLESHOOTING CHART

TROUBLE	SUGGESTED CAUSE OR TEST
Resistance from chassis to lug 2 of terminal strip B less than 5 megohms.	<ol style="list-style-type: none"> 1. Diode D5 or D6, or both, incorrectly installed or defective. 2. Capacitor C606 or C607, or both, defective. 3. Transformer winding shorted.
Less than 100 K Ω resistance from chassis to lug 2 of terminal strip L, or from lug 2 of terminal strip L to lug 1 of terminal strip X.	<ol style="list-style-type: none"> 1. Diodes D1, D2, D3, or D4 incorrectly installed or defective. 2. Capacitor C600 or C602A defective. 3. Transformer winding shorted.
Tube filaments do not light.	<ol style="list-style-type: none"> 1. Check fuse. 2. Check filament voltages.
No trace or spot.	<ol style="list-style-type: none"> 1. Controls improperly set. 2. SWEEP switch in RTTY or RF TRAP position. 3. Check CRT voltages. Refer to Figure 6 (fold-out from Page 28) for termination points of CRT socket leads. CAUTION: Use extreme care when measuring the high voltages present at these points.
Unable to center the trace on the screen.	<ol style="list-style-type: none"> 1. CLAMP switch pulled out. 2. Improper voltages on HOR and VERTICAL POS controls. 3. Check wiring of the yellow, orange, white, and violet CRT leads.
No vertical deflection.	<ol style="list-style-type: none"> 1. Check voltages of vertical amplifier tube V2. 2. Plate or grid circuits not tuned properly. 3. Open coil L1 or L2. 4. Red coaxial cable to L1 or to VERTICAL GAIN control open or shorted. 5. Large coaxial cable between lug 4 of terminal strip G and lug 2 of terminal strip J open or shorted.
No horizontal deflection.	<ol style="list-style-type: none"> 1. SWEEP switch not in INT position. 2. Check voltages of sweep generator tube V3A and V3B. 3. Check voltages of horizontal amplifier tube V3C. 4. SWEEP switch incorrectly wired. 5. HOR GAIN control not turned clockwise.

PART PARTS DESCRIPTION
No. Per Kit

WIRE-CABLE-HARNESS

89-1 1 Line cord
340-9 1 Bare wire
343-5 1 Coaxial cable
344-55 1 Hookup wire
134-130 1 Harness

SHEET METAL PARTS

90-337 1 Cabinet shell
(68) 206-304 1 CRT shield
(69) 100-329 1 CRT ring and pad assembly
200-463-1 1 Chassis
203-448-1 1 Front panel
(70) 207-1 2 CRT mounting clamp
(71) 210-31 1 Front bezel

MISCELLANEOUS

73-2 2 Rubber grommet
(72) 73-5 1 Rubber cushion strip
(73) 75-24 1 Line cord strain relief
(74) 84-39 1 1500 cps P.E.C. (packaged electronic circuit)

PART PARTS DESCRIPTION
No. Per Kit

MISCELLANEOUS (cont'd.)

~~84-40~~ 1 1950 cps P.E.C. (packaged electronic circuit)
(75) 260-7 1 Mounting clip
(76) 261-9 4 Rubber foot
(77) 261-25 2 Plastic foot
(78) 255-59 2 Foot spacer
(79) 413-10 1 Red plastic lens
421-20 1 1/2 ampere fuse
(80) 422-1 1 Fuse block
(81) 455-9 1 Bushing
462-30 1 Small knob
462-191 9 Skirted knob
(82) 481-1 1 Capacitor mounting wafer
414-9 1 Grid screen
391-44 1 Heathkit nameplate
490-1 1 Alignment tool
490-5 1 Nut starter
597-308 1 Kit Builders Guide
597-260 1 Parts Order Form
391-34 1 Blue and white identification label
1 Manual (see front cover for part number)
Solder

TROUBLE	SUGGESTED CAUSE OR TEST
No horizontal deflection with signal applied. (SWEEP switch in RTTY or RF TRAP position).	<ol style="list-style-type: none"> 1. RF demodulator tube V1A defective. 2. Coaxial cable from lug 2 of V1 to SWEEP switch open or shorted. 3. Coaxial cable from HOR input to SWEEP switch open or shorted.
Poor focusing.	<ol style="list-style-type: none"> 1. Protective covering not removed from grid screen. 2. Check for proper voltage on pin 4 of CRT. Note: Some astigmatism or defocusing may appear at the ends of the trace. This is normal and should not affect monitoring.
Distorted waveform.	<ol style="list-style-type: none"> 1. Input waveform distorted. 2. Input signal too strong, reduce VERTICAL GAIN control and/or signal.
2-tone generator signal absent or distorted.	<ol style="list-style-type: none"> 1. R404 and/or R407 improperly adjusted. 2. Coaxial cable to Tone output jack shorted. 3. Check voltages on V4A and V4B.

SPECIFICATIONS

VERTICAL AMPLIFIER

Input Resistance. 100 K Ω .

Sensitivity Chart

Optional Frequency Inputs	Nominal input voltage (rms) per inch of vertical deflection.
Untuned	10 cps to 400 cps. 2.0 v 400 cps to 10,000 cps (RTTY). 1.0 v 10 kc to 455 kc. 500 mv
Tuned	455 kc. 70 mv 1600 to 1680 kc. 200 mv 2075 kc. 200 mv 2215 kc. 200 mv 2475 kc. 200 mv 3000 kc. 400 mv 3055 kc. 400 mv 3395 kc. 500 mv 5000 to 6000 kc. 600 mv

HORIZONTAL AMPLIFIER

Frequency Response. ± 3 db from 3 cps to 15 kc.
 Sensitivity. 800 mv per inch deflection.
 Input Resistance. 1 megohm.

SWEEP GENERATOR

Recurrent Type. Sawtooth produced by internal sweep generator.
 Frequency. 15 to 200 cps (variable).

TONE OSCILLATORS

Frequencies. Approximately 1500 cps and 1950 cps.
 Output Voltage. 50 mv (nominal).

GENERAL

Frequency Coverage. 160 through 6 meters (50-75 Ω coaxial input).
 Signal Power Limits (at rear coaxial connector). 15 watts to 1 kilowatt (see Page 39 for use with Citizen's band power levels).



Tube And Diode Complement.	1 - 3RP1 CRT, medium persistence, green trace. 1 - 6BN8 Clamper, low level RF detector. 1 - 6C10 Sweep generator, horizontal amplifier. 1 - 6J11 Twin phase-shift tone generator. 1 - 6EW6 Vertical amplifier. 1 - Germanium diode, sync rectifier. 4 - Silicon diodes, B+ rectifiers. 2 - Selenium diodes, high voltage rectifiers.
Front Panel Controls.	Sweep. Sweep Frequency - pull for Clamp. Tone Generator. Horizontal Gain. Horizontal Position. Vertical Gain. Vertical Position. Focus. Intensity - AC Off.
Rear Panel Control.	Transmitter Attenuator. Attenuates to 24 db at approximately 8 db per step.
Power Supply.	Transformer operated, fused at 1/2 ampere.
Power Requirements.	105-125 or 210-250 volts AC, 50/60 cps, 35 watts.
Dimensions.	6-5/8" high x 10" wide x 11-1/8" deep (including knobs).
Net Weight.	9 lbs. 10 oz.

The Heath Company reserves the right to discontinue instruments and to change specifications at any time without incurring obligation

to incorporate new features in instruments previously sold.

all Power Supply voltages
~~-1400V line~~
~~+250V line~~

CIRCUIT DESCRIPTION

Refer to the Schematic Diagram (fold-out from Page 55) and the Block Diagram while you read this Circuit Description.

Several of the circuits in the Monitor Scope are interdependent and affect the display on the screen of the CRT. Each circuit will be described separately. A review of the Installation And Operation section, and the Control Functions section of this Manual will also help you understand the function of the circuits and their relationship to each other.

VERTICAL DEFLECTION

Receiver Monitoring

When the Vertical Input of the Scope is properly connected to the IF amplifier stage of a receiver, and the receiver tuned to a signal, the vertical section operates as follows:

The signal is "sampled" (a small portion is taken) from the IF stage of the receiver, and coupled through the Vertical Input jack of the Scope to the vertical amplifier. Coil L1 and capacitor C1 (used for frequencies between 3000 kc and 6000 kc) tune the vertical input circuit to the IF frequency. For frequencies below 3000 kc L1, C1, and C3 are omitted, and the signal is coupled from the Vertical Input jack, through the Vertical Gain control, to the grid of the vertical amplifier tube V2.

The signal is then amplified in V2 and coupled through capacitor C512 to one of the vertical deflection plates of the CRT, V5. Coil L2 and capacitor C2 form the plate load for V2 at frequencies between 455 kc and 6000 kc, and are tuned to the IF frequency. For frequencies below 455 kc and for RTTY, R2 replaces L2 and C2 as a plate load for V2, and the plate circuit is untuned.

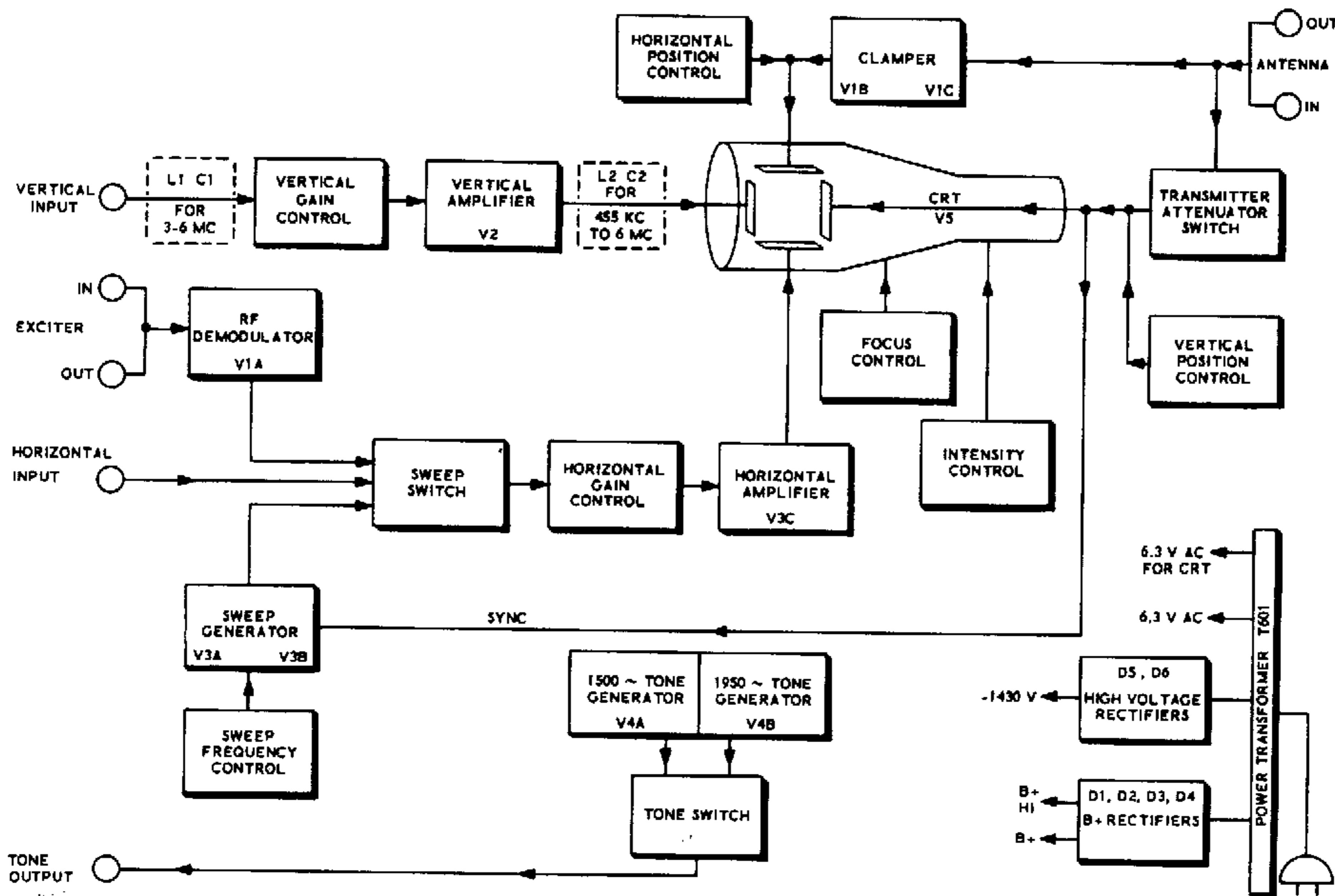

BLOCK DIAGRAM

Transmitter Monitoring

Transmitter signals as high as several kilowatts can be monitored on the Scope when they are connected to a properly terminated 50 or 75 ohm transmission line. The transmitter's antenna feed-line is coupled through the Antenna jacks on the scope, causing a portion of the RF voltage to be sampled from the feed-line. This sample can be reduced a total of 24 db (in approximately 8 db steps) by the Transmitter Attenuator switch before it is coupled through capacitor C507 to a vertical deflection plate in the CRT.

Since the antenna circuit of the Scope is untuned, it is essentially independent of frequency from several kc to more than 100 mc although some distortion of pattern may exist when used on 2 meters.

HORIZONTAL DEFLECTION

The position of the Sweep switch determines the signal that will be used for horizontal deflection in the CRT. When the Sweep switch is in the RTTY position, any appropriate signal coupled to the Horizontal input jack is passed through capacitor C303, the Horizontal Gain control, and resistor R309, to horizontal amplifier V3C.

In the RF Trapezoid position, a signal from the Exciter jacks is rectified (demodulated) by RF demodulator tube V1A. The rectified RF voltage is taken from the cathode of V1A and passed through C303 to the Horizontal Gain control. The Internal position of the Sweep switch couples an internally generated sawtooth waveform to the Horizontal Gain control.

Sweep Generator

The sweep generator circuit is made up of two sections of the 6C10 triple triode compactron

tube, V3A and V3B. The two triode sections are connected in such a manner that they operate as a free-running multivibrator sawtooth generator. The sawtooth frequency can be varied from approximately 15 to 200 cps by adjusting the Sweep Frequency control.

A portion of the RF signal that is fed to the vertical deflection plate of the CRT is coupled by capacitor C506 and resistor R513, and the network of D7, R512, C505, and R511, to the cathode of sweep generator tube V3A. This signal helps to synchronize the frequency of the sweep generator with the frequency of the displayed signal. A stabilized pattern is thus displayed on the screen of the CRT.

Horizontal Amplifier

The third triode section of the 6C10 compactron tube, V3C, is used as a horizontal amplifier. The sweep signal that is selected by the Sweep switch is coupled through capacitors C302 and C303 to the Horizontal Gain control. From this control, the signal is fed to the grid of V3C. After amplification, the signal is coupled through capacitor C304 to one of the horizontal deflection plates of the CRT. When the Sweep switch is in the Internal position, capacitor C502 is connected between this horizontal deflection plate and the grid of the CRT to provide a blanking signal during retrace time.

Clamper Circuit

When no signal is present during the set up for a trapezoid display of a transmitted signal, the trace is reduced to a small spot. This spot could burn the phosphor coating on the face of the CRT if it is left at high brightness for a prolonged period of time. A clamper circuit in the Scope causes the spot to be deflected off of the screen when no signal is present.

The clamper consists of diode V1C and triode V1B, which function as follows:

With the Sweep switch in the INT position, or with the Clamp switch pushed in, the cathode circuit of V1B is open and the tube has no effect on the normal deflection in the CRT. The dot or pattern can be centered on the screen and a normal display shown. When the Sweep switch is turned to RF Trapezoid or RTTY, and the Clamp switch pulled out, the cathode of V1B is grounded. This permits V1B to conduct, changing the voltage on its plate, and on the horizontal deflection plate of the CRT, which moves the spot to one side of the tube.

When an RF transmitter signal is impressed on the cathode of V1C, it is rectified and passed to the grid of V1B. This rise in grid voltage causes V1B to stop conducting, which returns its plate voltage and the voltage on the deflection plate in the CRT to normal, causing the display to return to the center of the CRT screen.

2-TONE OSCILLATORS

A 1500 cps tone signal is generated in the oscillator circuit of V4A and a 1950 cps tone signal is generated by V4B. The circuits of these two oscillators are identical except for the P.E.C. (packaged electronic circuit) phase shift networks, which contain five capacitors and four resistors.

The P.E.C. networks are designed to produce a phase shift of 180 degrees from plate to grid, at the proper frequency, to sustain oscillation. In each of the two circuits, the frequency is such

that any second harmonic present in the 2-tone output will fall outside the passband of most SSB filters.

The Tone Generator switch turns on the two oscillator circuits by applying screen voltage to V4A in the 1.5 kc position, and to V4A and V4B in the 2-tone position. Potentiometers R404 and R407 allow the tone level and the two-tone amplitude balance to be adjusted. The 1500 cps tone, or the 2-tone signal, is coupled to a Tone jack on the rear of the chassis for test purposes or for external application to a transmitter modulator stage.

POWER SUPPLY

The transformer operated power supply uses two selenium rectifiers, D5 and D6, in a full-wave voltage doubler circuit to provide -1430 volts for the cathode ray tube. Another winding of the transformer is coupled to silicon diodes D1, D2, D3, and D4, in a full-wave voltage doubler circuit to provide +600 volts DC. The return lead of this winding provides +290 volts and, through resistor and capacitor networks, furnishes +280 volts and +210 volts.

Filament voltage for tubes V1, V2, V3, and V4 is taken from a 6.3 volt winding of the transformer. Voltage for the CRT filament is supplied by a separate winding, and is coupled through the Intensity control to the -1430 volt source to keep the potential difference between the filament and cathode within safe limits.

The two primary windings of the power transformer can be connected in parallel for 120 volt operation, or in series for 240 volt operation. The primary circuit is fused and contains a switch that is attached to the Intensity control.

INTRODUCTION

The Heathkit Model SB-610 Monitor Scope is a convenient instrument for use with an amateur radio station to monitor "on-the-air" signals. The Scope can be used on any amateur band, or other frequency, from 160 through 6 meters without additional tuning or modification. It can also be used for citizen's band transceiver monitoring when a small modification is made to the Scope.

The primary function of the Monitor Scope is to display the transmitted signal pattern, RF envelope, RF trapezoid, or radioteletype (RTTY) cross pattern. It can also be used to monitor radio signals from other stations when used in conjunction with a receiver.

A 2-tone generator (1500 and 1950 cps sine wave audio oscillators) is built into the Scope for single sideband adjustment and other test purposes. The Scope also has a special one-piece shield for the cathode ray tube to minimize the effects of stray magnetic fields on the trace.

Cabinet and front panel styling of the Model SB-610 Monitor Scope matches that of the Heath SB Series of amateur single-sideband equipment.

NOTE: Refer to the Kit Builders Guide for complete information on unpacking, parts identification, tools, wiring, soldering, and step-by-step assembly procedures.

SCHEMATIC OF THE HEATHKIT MONITOR SCOPE MODEL SB - 610

