

15 kHz Multiple Feedback (MFB)  
Low Pass Chebychev Filter.  
0,01 dB ripple.

Ka+Ruud  
Tronics

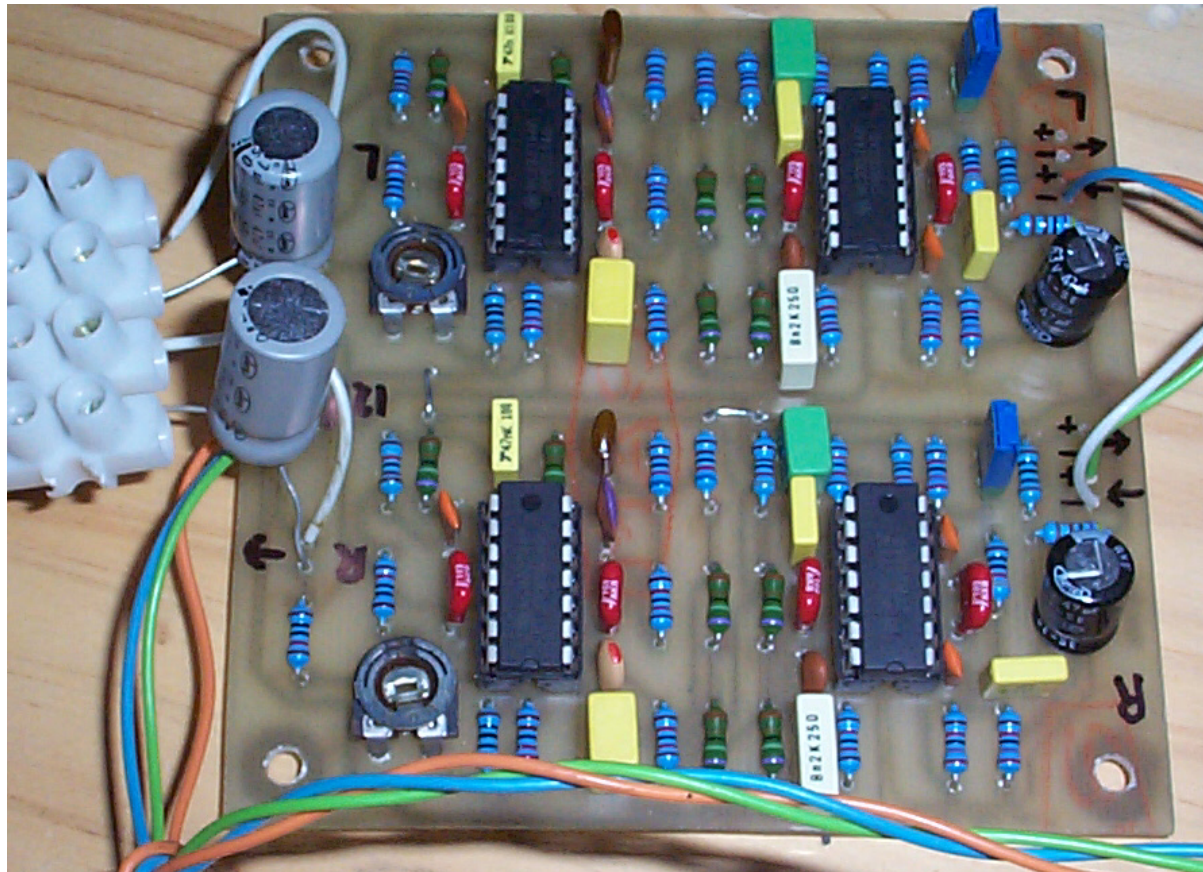

19 kHz suppression is  $>39$  dB

*This filter will improve the performance of your  
Stereo Coder considerably.*

*Dit filter zal de kwaliteit van uw Stereo Coder  
aanzienlijk verbeteren*

# Aansluitingen Filter

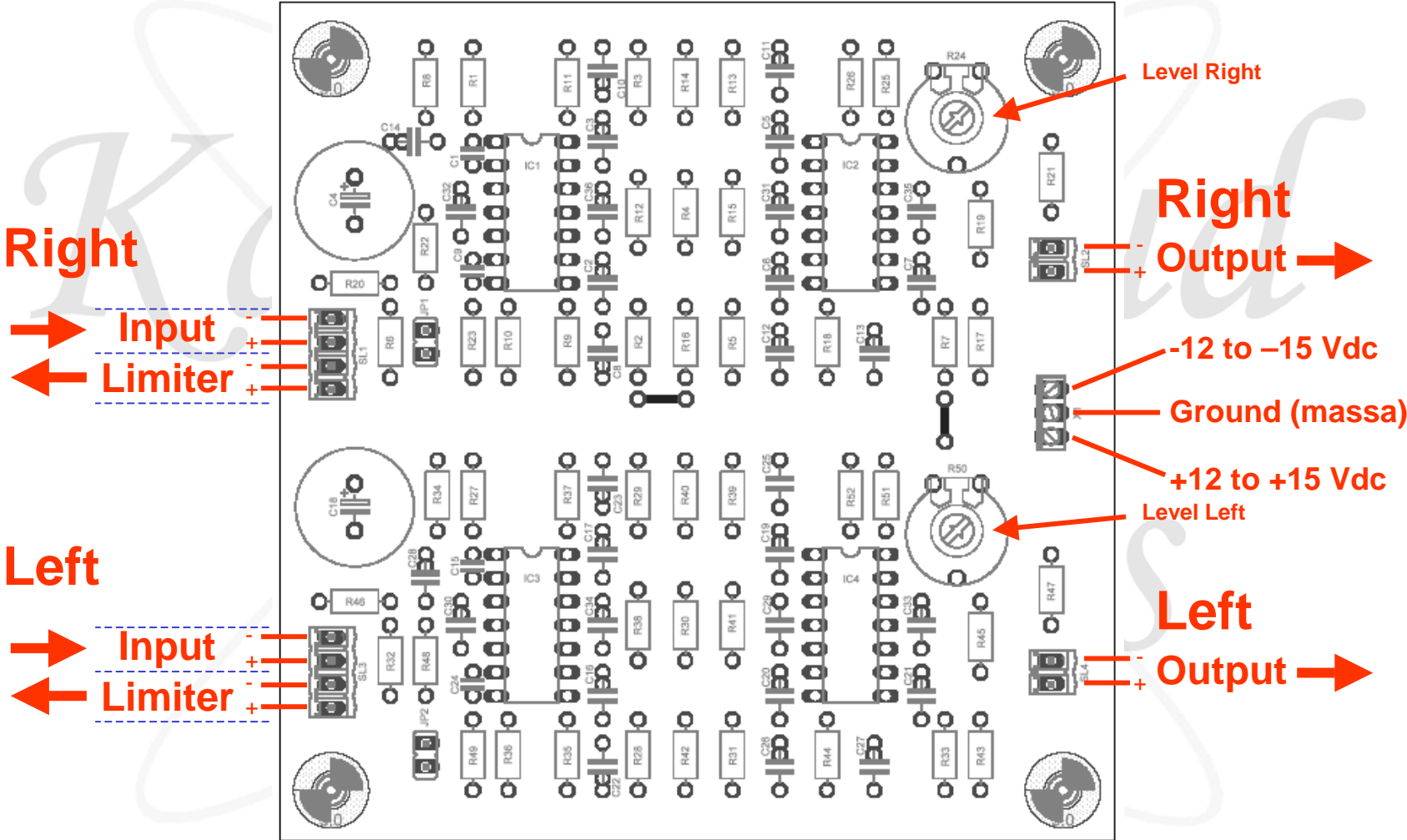

# Connections Filter

# Suppression (Onderdrukking)

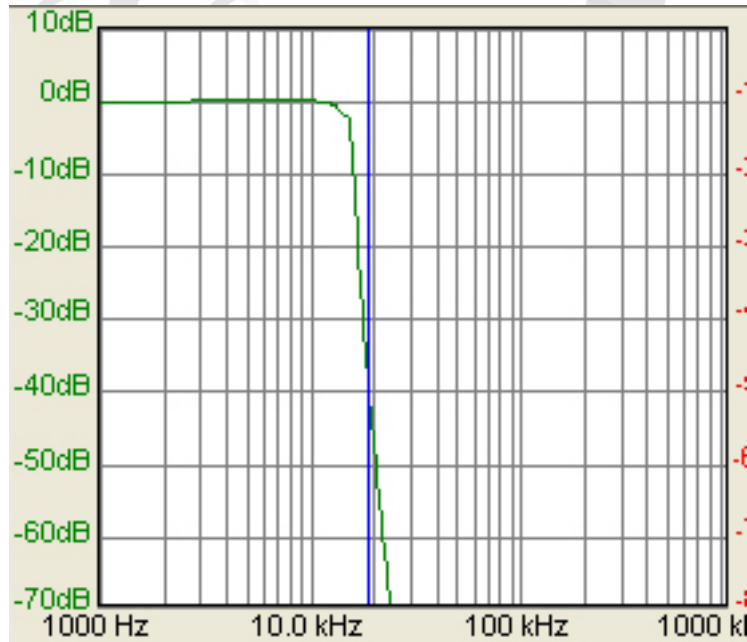

Suppression @ 19 kHz > 39 dB

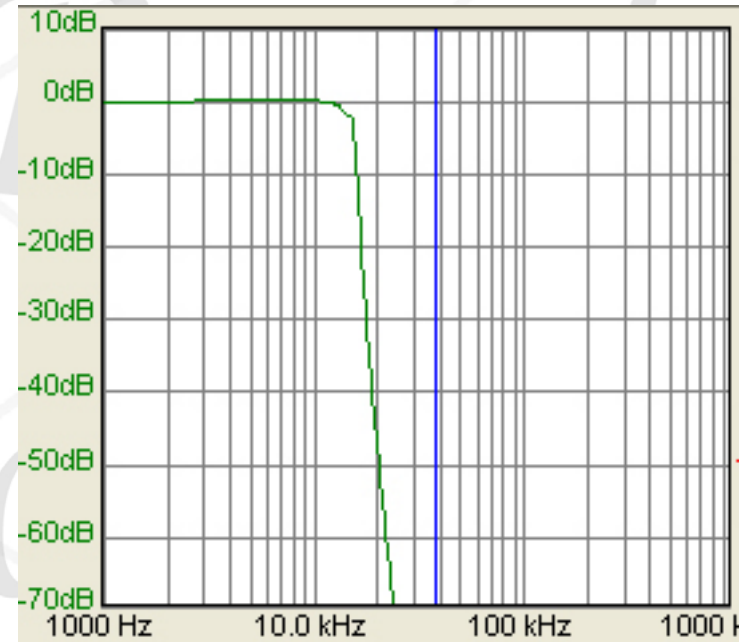

Suppression @ 38 kHz > 114 dB

# Contact

*If you have any questions  
or problems about this filter.*

*Please don't hesitate to  
contact me at.*

*Als je vragen en of  
problemen hebt over dit  
filter, aarzel dan niet*

*om kontakt met mij op te  
nemen.*

**[katruud@quicknet.nl](mailto:katruud@quicknet.nl)**



*Filter and Power Supply used for testing*

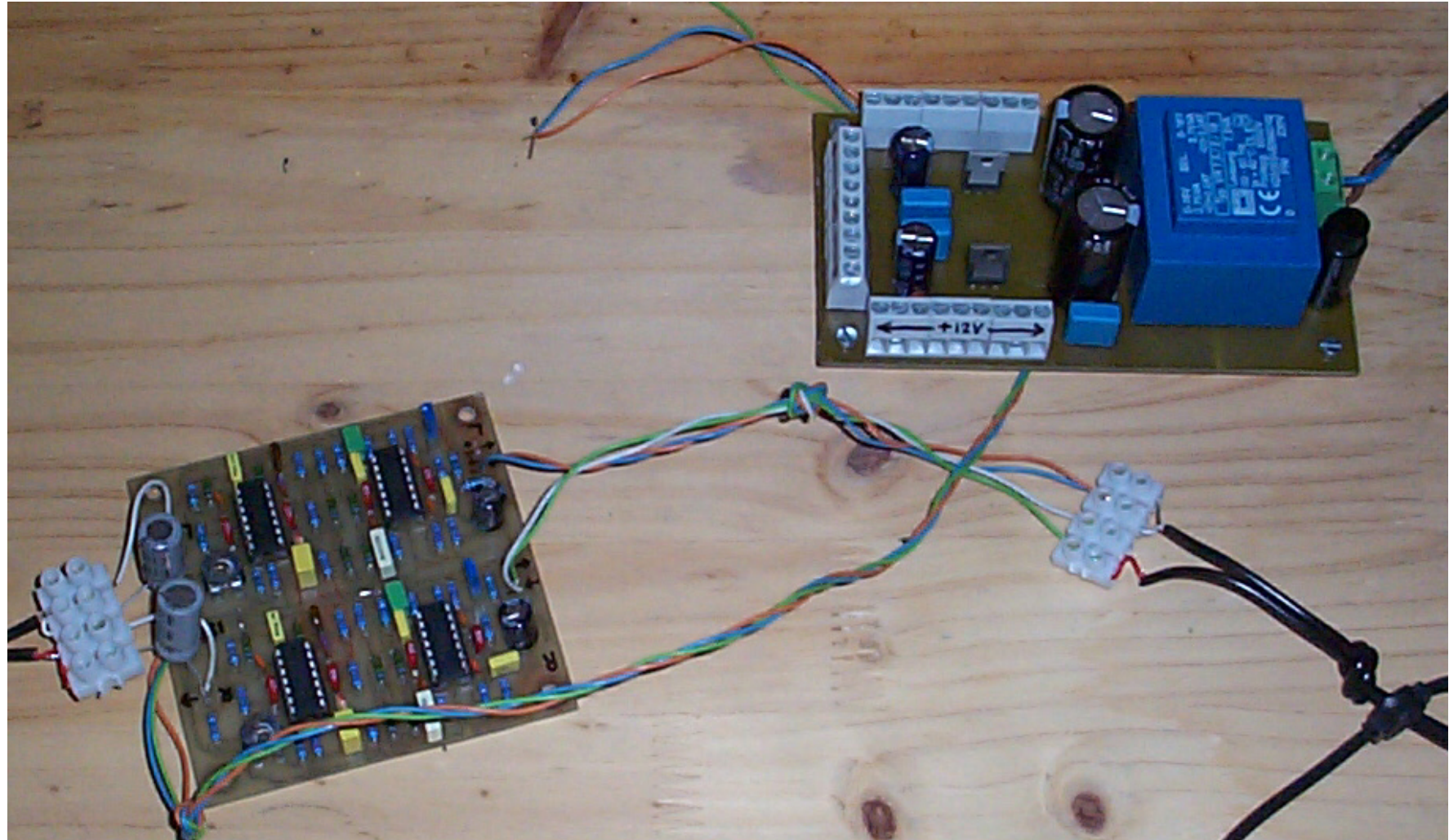

*Filter en Voeding die zijn gebruikt voor het testen*

# Prototypes

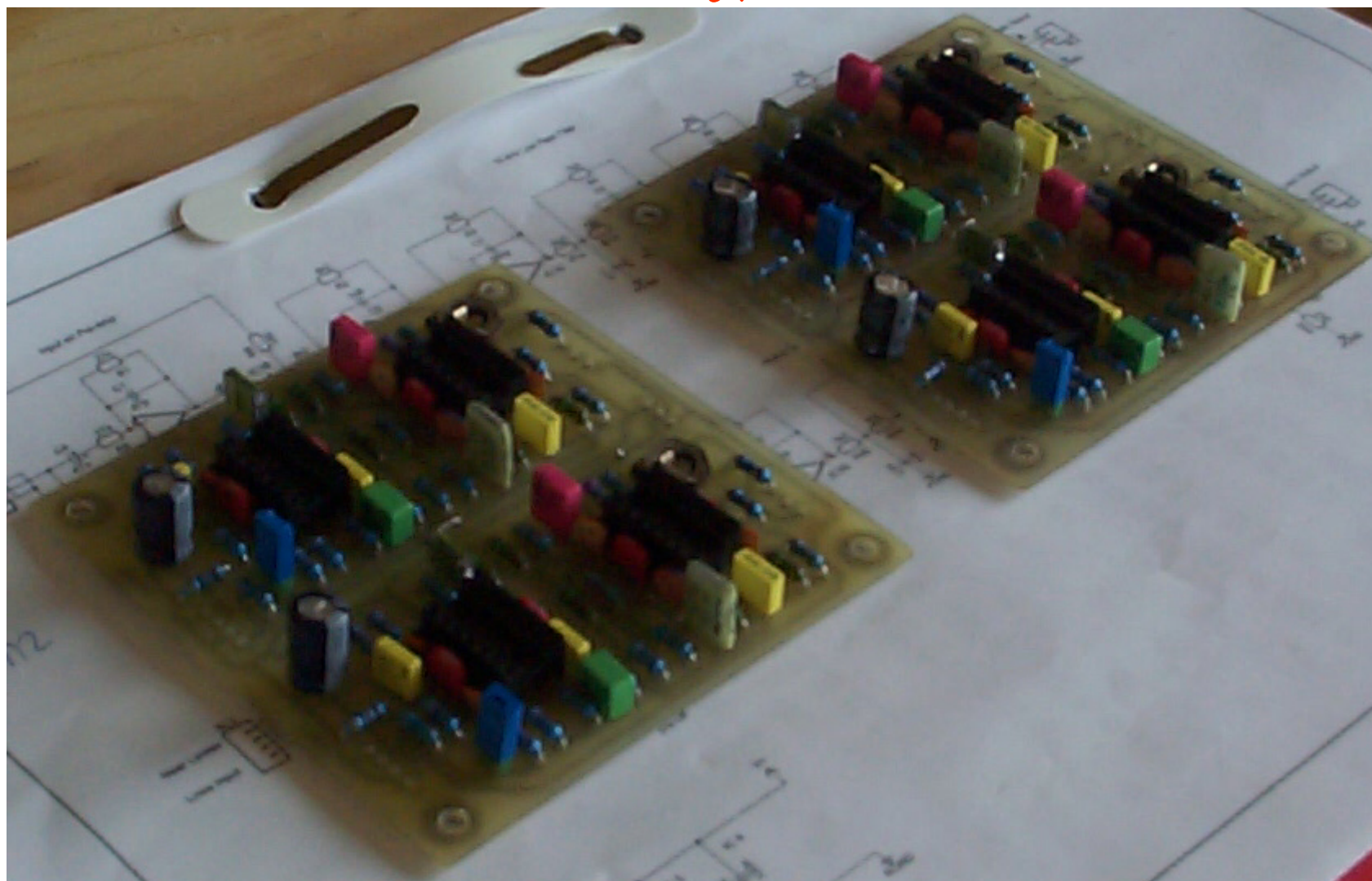



# Pictures

*No pre-emphasis*

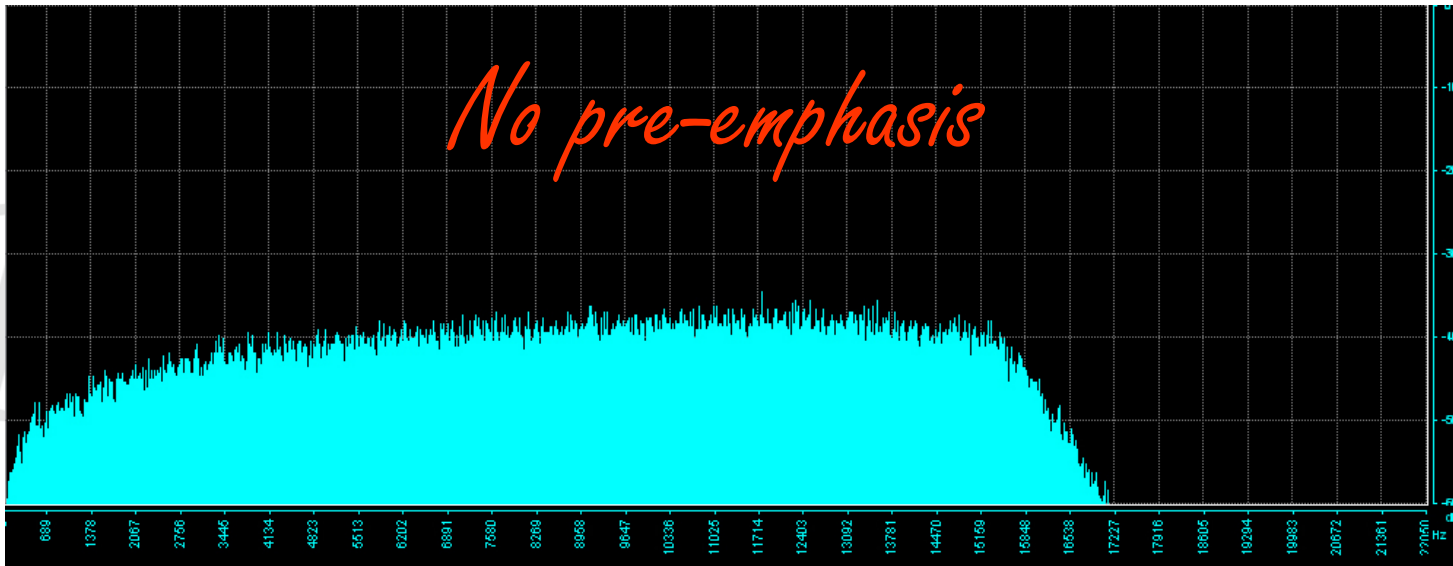

*With 50uSec pre-emphasis*

