

ELENOS

BROADCAST EQUIPMENT COMPANY



USER AND MAINTENANCE MANUAL

ETG101 ETG151



TECHNICAL ANNEX

ELENOS

Via G. Amendola 9 - 44028 Poggio Renatico (FE) - Italy
Phone. +39 0532 829 965 - Fax +39 0532 829 177
E-Mail: info@elenos.com
Internet address: www.elenos.com

Edition 1
Rev. 1 - 02/08/2001
Code MAN0074

Dear User,

Firstly, thank you for choosing an **ELENOS** product.

ELENOS products are solid state or thermionic tube transmitters that develop power from a minimum of 20W to a maximum of 30KW.

Great care has been taken during the design of the protection circuitry to ensure compatibility with products from other manufacturers. However the best performance is achieved when the equipment is used with other products manufactured by **ELENOS**.

The unit has been designed to guarantee consistent performance over time, without the need for special maintenance. The need for this is minimised by regular functional checks of those components which are ventilated.

Operation of the unit is very easy and intuitive. Even so it is recommended that this manual and other relevant documentation is read carefully before any operation is attempted.

Customer Care

CONTENTS

1. GENERAL

1.1. Front ViewPage 5

 1.1.1. Front panel descriptionPage 5

1.2. Rear View.....Page 7

 1.2.1. Rear panel description.....Page 7



2. INSTALLATIONPage 9



3. USER INSTRUCTIONS

3.1. User interfacePage 10

3.2. Telemetry connection and operationPage 11

3.3. Powering upPage 13

3.4. Description of the graphics interface, setup and measurement

 3.4.1. Main menuPage 14

 3.4.2. Functions menuPage 15

 3.4.3. Audio menu - Input signal level adjustmentPage 16

 3.4.4. RF menu - Output power adjustmentPage 17

 3.4.5. Frequency menu - Frequency programmingPage 18

 3.4.6. User setup menu.....Page 19

 3.4.7. Timer displayPage 20

 3.4.8. RDS menu - RDS adjustment and programming (optional)Page 21

 3.4.9. Deviation e Statistics menuPage 25

 3.4.10. RDS encoder programmingPage 27

3.5. Checking performance.....Page 39



4. GENERAL DESCRIPTION

4.1. Introduction.....Page 41

4.2. Using the block diagramPage 41

4.3. Block diagramPage 43*

4.4. Power supply sectionPage 45

 4.4.1. ServicesPage 45

4.5. Radio frequency sectionPage 46

 4.5.1. DriverPage 46

 4.5.2. RF modulesPage 46

 4.5.3. Low-pass filterPage 47

 4.5.4. Probe

 4.5.4.1. Output power measurementPage 47

 4.5.4.2. AGC protectionPage 47

4.6. Logic (Mother board)Page 47

 4.6.1. CPU board.....Page 48

 4.6.2. ALC boardPage 48

 4.6.3. VCO/PLL board.....Page 48

 4.6.4. MPX boardPage 48

4.7. KeyboardPage 48

4.8. Optional boards.....Page 49

 4.8.1. Stereo input boardPage 49

 4.8.2. Stereo encoder boardPage 50

 4.8.3. RDS boardPage 51



5. ELECTRICAL SCHEMATICS	
5.1. Auxiliary power supply	
5.1.1. Layout.....	Page 55
5.1.2. Schematic	Page 57*
5.1.3. Parts list	Page 59
5.2. Mother board	
5.2.1. Layout.....	Page 61*
5.2.2. Schematics	
5.2.2.1. VCO	Page 63*
5.2.2.2. PLL	Page 65*
5.2.2.3. MPX	Page 67*
5.2.2.4. AGC and SWR protection.....	Page 69*
5.2.2.5. CPU	Page 71*
5.2.3. Parts list	Page 73
5.3. Keyboard	
5.3.1. Layout.....	Page 83
5.3.2. Schematic	Page 85*
5.3.3. Parts list	Page 87
5.4. Driver	
5.4.1. Layout.....	Page 89
5.4.2. Schematic	Page 90
5.4.3. Parts list	Page 91
5.5. RF final output stage	
5.5.1. Layout.....	Page 93
5.5.2. Schematic	Page 94
5.5.3. Parts list	Page 95
5.6. LP filter	
5.6.1. Layout.....	Page 97
5.6.2. Schematics	
5.6.2.1. Directional coupler	Page 98
5.6.2.2. Directional coupler amplifier.....	Page 99
5.6.2.3. Low-pass filter	Page 100
5.6.3. Parts list	Page 101
5.7. Input output combiner system	
5.7.1. Schematic	Page 103
5.8. BUS board	
5.8.1. Layout.....	Page 105
5.8.2. Schematic	Page 106
5.8.3. Parts list	Page 107
5.9. Thermal probe	
5.9.1. Layout.....	Page 109
5.9.2. Schematic	Page 109
5.9.3. Part list.....	Page 110



6. TROUBLESHOOTING	Page 111
--------------------------	----------



7. TECHNICAL SPECIFICATION	Page 113
----------------------------------	----------

1.1. Front view

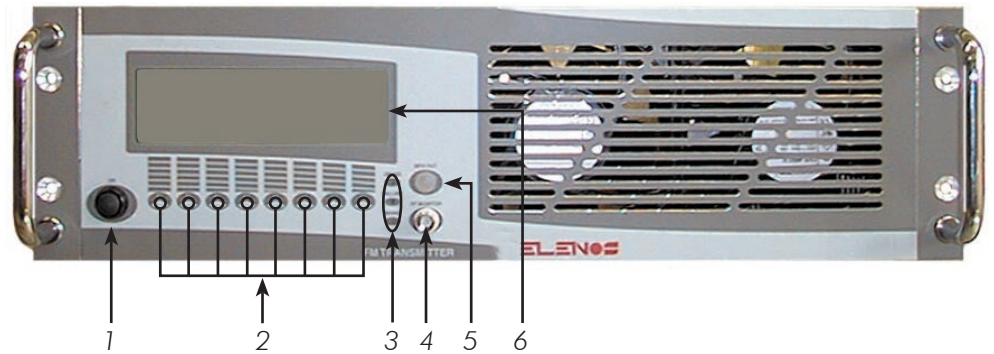

1.1.1. Front Panel description

- 1) Power on switch
- 2) Switches for programming operation
- 3) Led: "ON AIR" lit, indicates the PLL has reached the desired frequency
"FAULT" lit, indicates the output power is below the preset threshold
"MAINS" lit, indicates the unit is switched on
- 4) The "RF monitor" connector provides an RF monitor signal
- 5) The "MPX OUT" connector provides an audio signal
- 6) Display

N.B.

Do not obstruct the ventilation grills

1.2.
Rear view

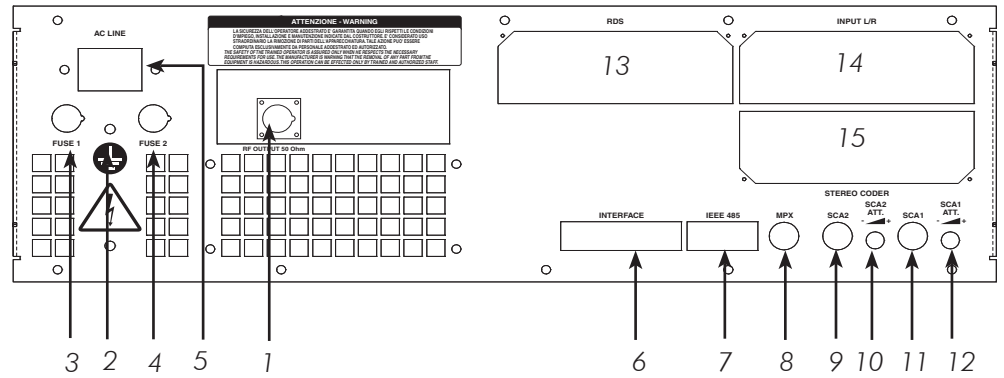

1.2.1.
Rear Panel description

- 1) "RF OUT" connector
- 2) Earthing terminal
- 3-4) Power supply fuse (10A)
- 5) Line supply socket
- 6) Analog signal interface
- 7) Telemetry interface
- 8) "MPX" input connector
- 9) "SCA2" input connector
- 10) Trimmer for calibrating the "SCA2" input
- 11) "SCA1" input connector
- 12) Trimmer for calibrating the "SCA1" input
- 13) Slot for inserting the RDS board
- 14) Slot for inserting the stereo inputs board
- 15) Slot for inserting the stereo encoder board

N.B.

Do not obstruct the ventilation grills

2. Installation



Remove the unit from its packaging and before attempting any operation, check that the unit has not been damaged during transport and that all the switches and connectors located on the front and rear panels are serviceable.

- ☞ Install the unit so that it is accessible from all sides
- ☞ Ensure that the location of the unit allows for connection to an efficient earthing point
- ☞ Ensure that the antenna system is suitable
- ☞ Check that any amplifier to be eventually connected downstream is connected to the antenna system
- ☞ Connect the appropriate inputs of the exciter according to the type of operation required:
 - ☞ the monophonic signal to the XLR connector on the mono board
 - ☞ the stereo signal (low frequency) to the left and right XLR connectors on the stereo input board
 - ☞ the stereo signal (wide-band) to the MPX connector on the MPX and SCA inputs board
 - ☞ the RDS signal to one of the two SCA connectors on the MPX and SCA inputs board
 - ☞ If the RDS board is fitted, the wide-band stereo signal goes directly to the MPX inputs on the RDS board, so the MPX+RDS output will be connected to the MPX input on the MPX and SCA inputs board.
- ☞ Connect the electricity supply cable
- ☞ Connect the RF output to the input of any amplifier to be used, or to the antenna system
- ☞ Switch on the amplifier (if present)
- ☞ In order to verify that the equipment is functioning correctly, check the values displayed by the exciter and amplifier displays and instrumentation

3.1.
User interface

The user interface is designed to accept upto 14 analog signals in the range 0 to 2V. For example, it is possible to read a remote temperature, remote voltages and currents of other equipment and direct and reflected power of other equipment.

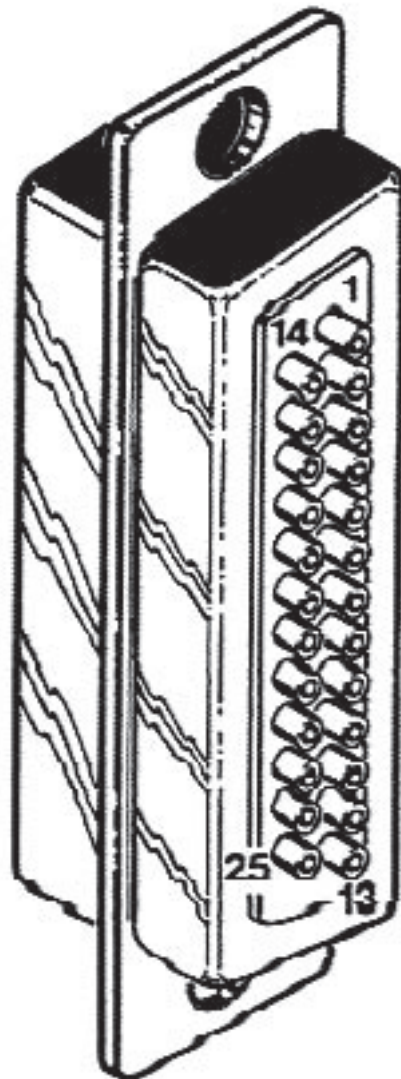

1	IN1
2	IN2
3	GND
4	GND
5	NC
6	NC
7	NC
8	IN3
9	IN4
10	IN5
11	IN6
12	IN7
13	IN8
14	GND
15	GND
16	NC
17	GND
18	IN9
19	NC
20	NC
21	IN10
22	IN11
23	IN12
24	IN13
25	IN14

Pins with an "IN" prefix are inputs
Pins with an "NC" prefix are not connected
Pins with a "GND" prefix are earths

3.2.
Telemetry
Connection
and operation



The ETG101's (ETG151's) telemetry feature allows an IBM compatible PC to be connected directly to the unit, or via a GSM modem. The main operational parameters can be displayed and modified via telemetry using the Hyper Terminal software supplied with any version of Microsoft Windows (c).

Connect the unit to a GSM modem, or directly to a PC, using the cable supplied (see diagram below).

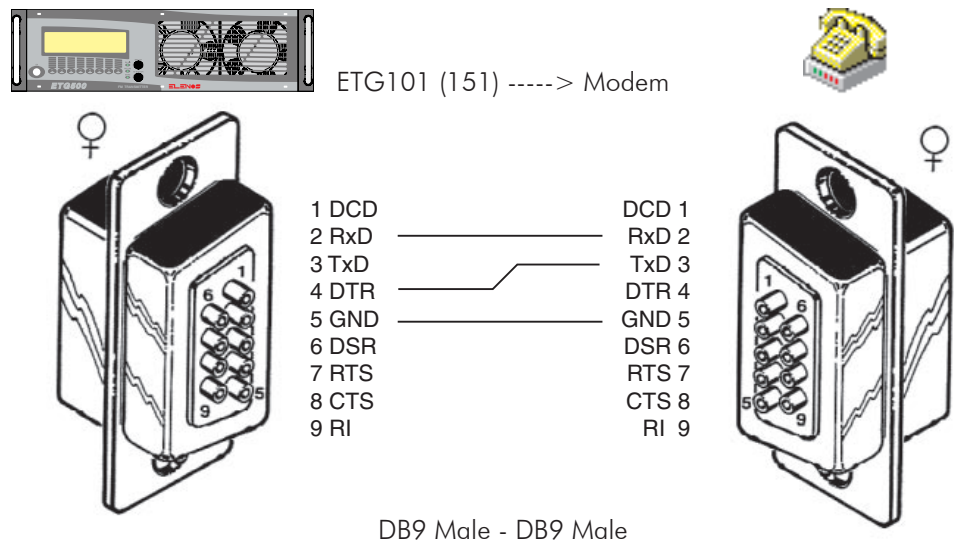
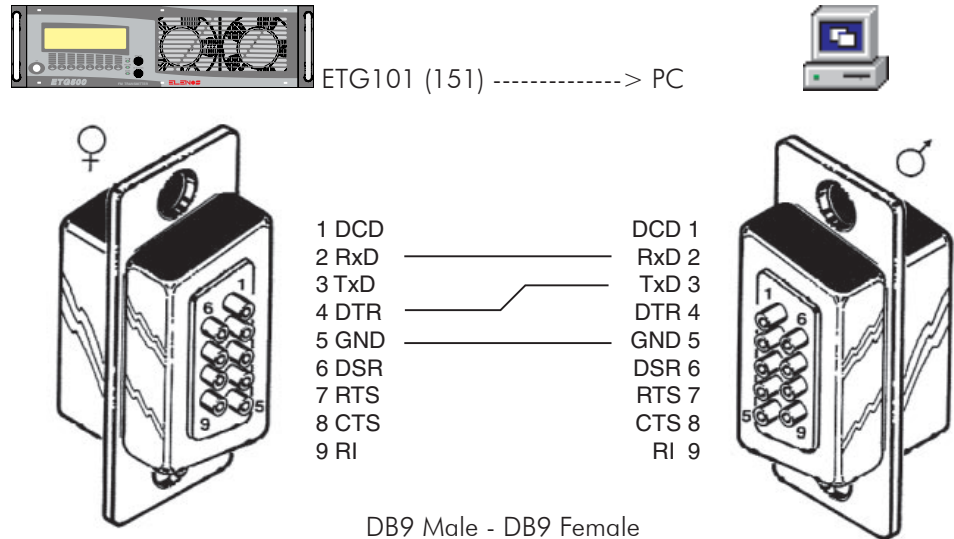

Run the Hyper Terminal software supplied with Microsoft Windows. Enable the connection (to connect via modem, refer to the configuration in the GSM modem manual).

Telemetry will now be available on the PC, but to transfer data, the code \$1111 must be entered; only then may the unit's parameters be displayed and modified.

3.2. Telemetry Connection and operation
Main Screen

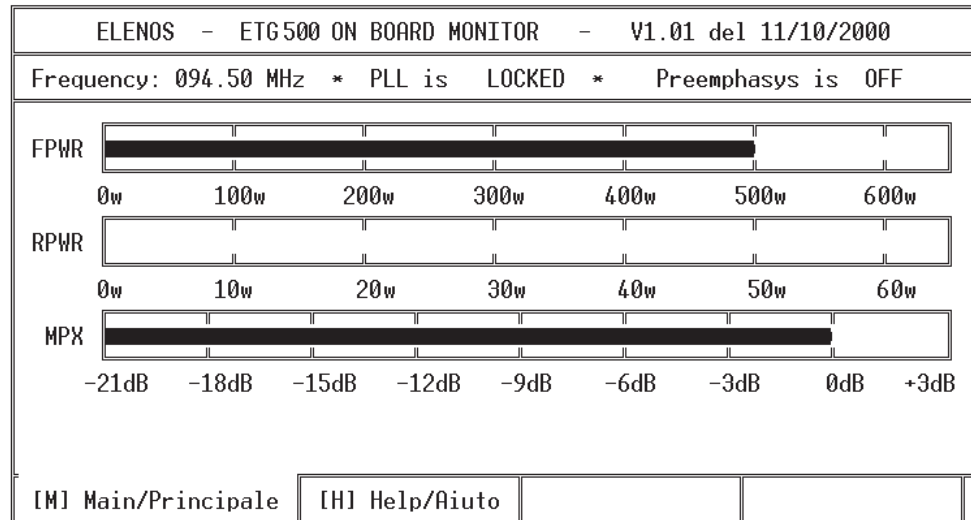

The following parameters can be viewed on the main screen: the programmed frequency, the status of the PLL, the status of pre-emphasis, the level of direct power, the level of reflected power and the audio level.

From this screen the output power can be increased or decreased by pressing the "P" key with either the "+" or "-" keys respectively. Once the desired value has been reached, it can be saved by pressing the "S" key.

To modify the frequency, press the "F" key with either the "+" or "-" keys to increase or decrease the frequency respectively. Once the desired frequency has been reached, it can be saved by pressing the "S" key.

To terminate transmission of data, type "\$C".

Pressing the "H" (help) key will open the help screen where all the above commands are identified (see diagram below).

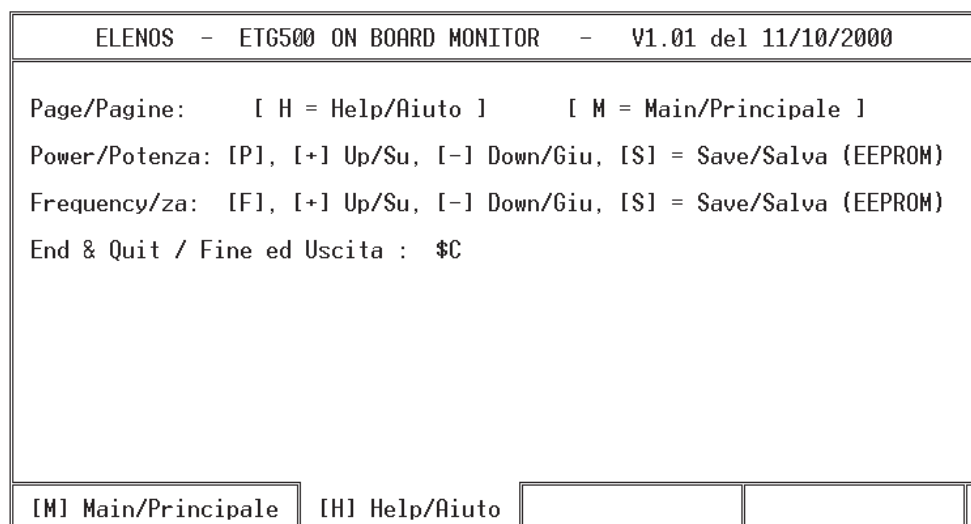

Press the "M" (Main) key to return to the main screen.

3.3.
Powering up

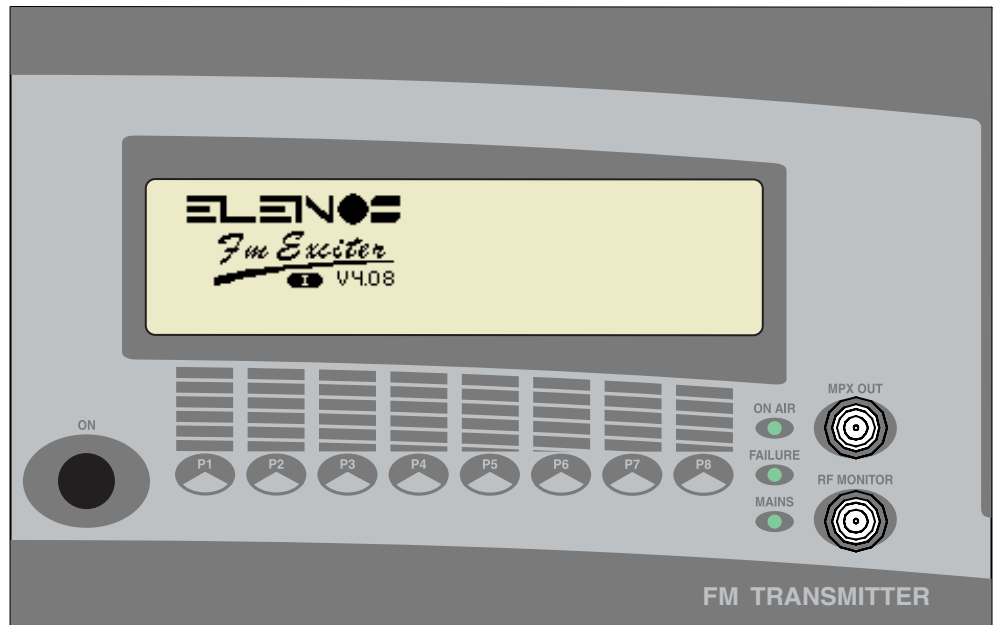

- The start up screen appears showing the state of the audio BUS.
- The microprocessor runs a system check to verify which optional boards have been fitted.
- The countdown starts (duration 8 seconds) after which the exciter will develop power.

Pressing keys during the countdown:

- ☞ Pressing any key will prevent power from being developed
- ☞ Pressing F1 +F8 will terminate the countdown

On termination of the countdown, the main menu will appear (with the ELENOS logo or that of the customer)

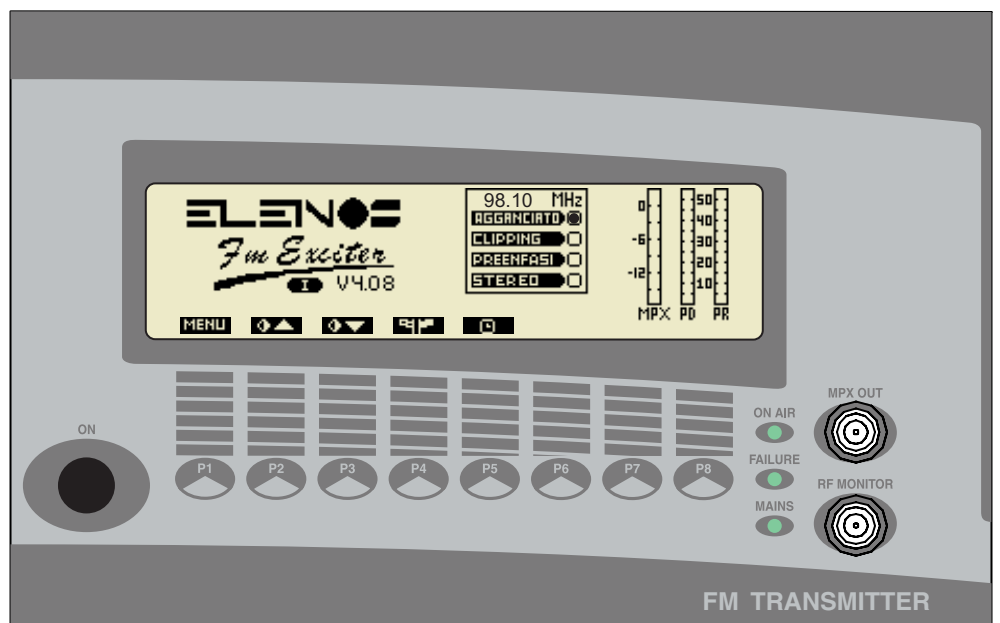

3.4.1. Main Menu

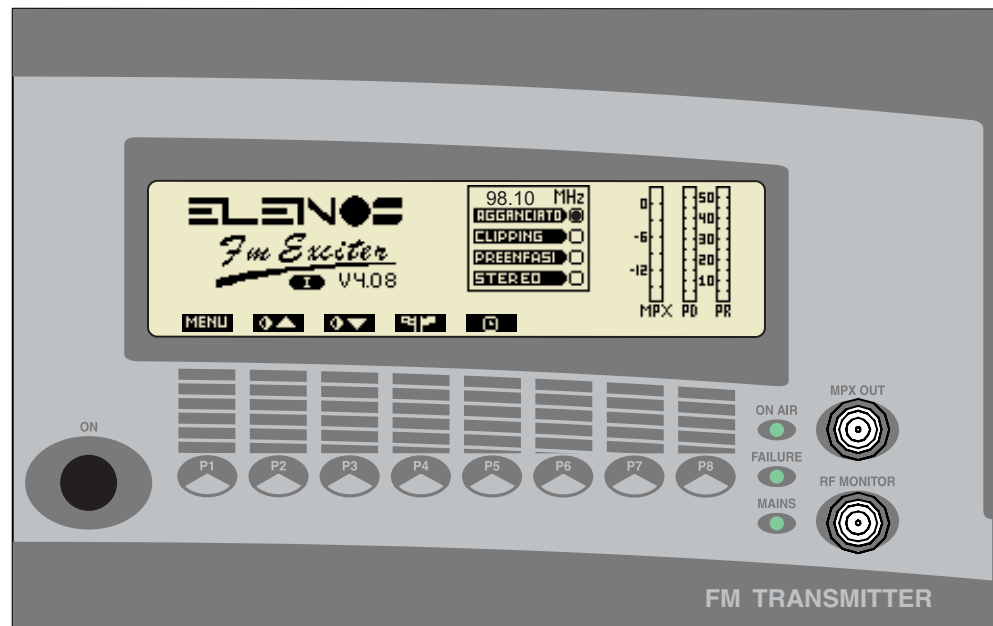

- Press key P1 to access the menu functions
- Press key P2 to increase the contrast of the display
- Press key P3 to reduce the contrast of the display
- Press key P4 repetitively to select the desired language
The language of the display will change each time the key is pressed
The language selected will be indicated by a letter under the ELENOS logo.
- Press key P5 to display the time for which the unit has been operated.

The main menu displays respectively: MPX level, direct power, reflected power, operating frequency, PLL lock, clipper operation, insertion of pre-emphasis and insertion of the stereo encoder.

The logo displayed by the unit can be personalised on the request of the user. The default logo is that of ELENOS with which is also displayed the version of software installed (e.g. V4.08) and the language selected (e.g. UK)

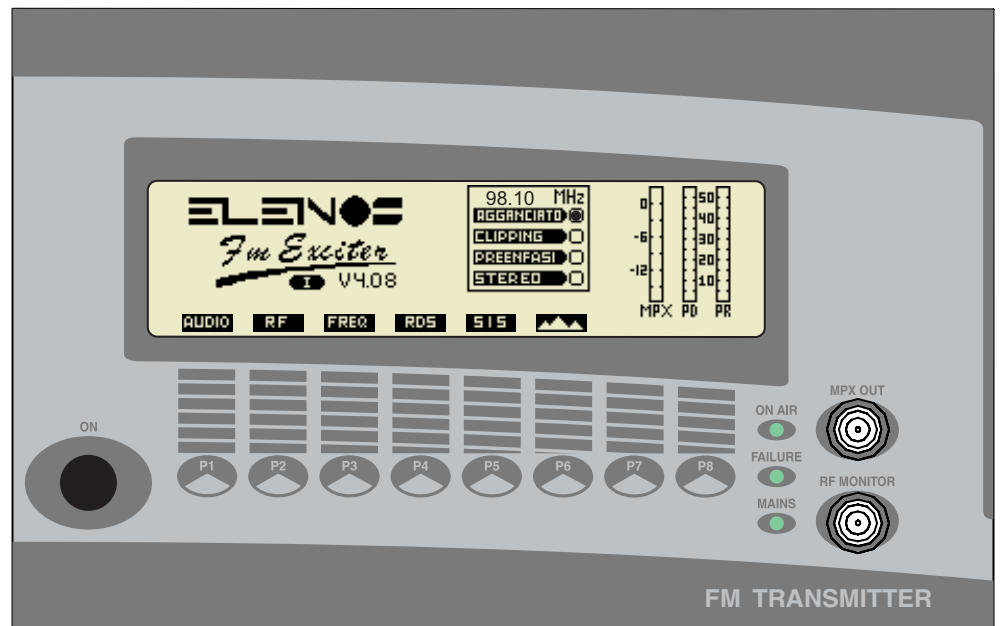
3.4.2.
Functions Menu

- ☞ Press key P1 to access the audio menu
- ☞ Press key P2 to access the RF menu
- ☞ Press key P3 to access the frequency programming menu
- ☞ Press key P4 to access the RDS menu if the optional RDS board is fitted
- ☞ Press key P5 to access the user setup menu
- ☞ Press key P6 to access the deviation and statistics menu

The following parameters are displayed in the Functions menu: MPX level, direct power, reflected power, operating frequency, PLL lock, clipper operation, insertion of pre-emphasis and activation of the stereo encoder.

Once the functions menu has been entered, if no key is pressed, the main menu will automatically appear after 10 seconds.

3.4.3. Adjustment of the input signal level Audio Menu

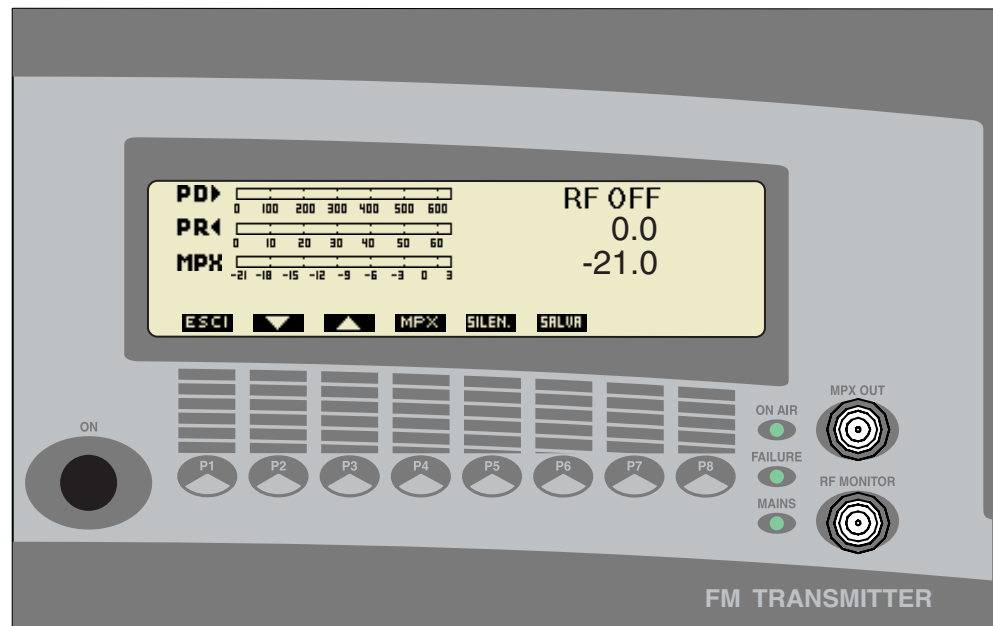

- Press key P1 to return to the functions menu
- Press key P4 to set the input signal level (default 0dBm)
- Press key P2 to reduce the input signal level
- Press key P3 to increase the input signal level
- Press key P6 to save the adjustment made
- Press key P5 to disable or re-enable the audio signal

The audio menu displays the following parameters: direct power, reflected power and MPX signal level in both “analog” and numerical form. In the diagram direct power is disabled (RF OFF), the reflected power is 0W and the MPX signal level is -21dBm.

If the stereo encoder is present, the indication of direct and reflected power is replaced by the level of the signals on the left and right channels.

3.4.4. **Adjustment of output power**
RF Menu

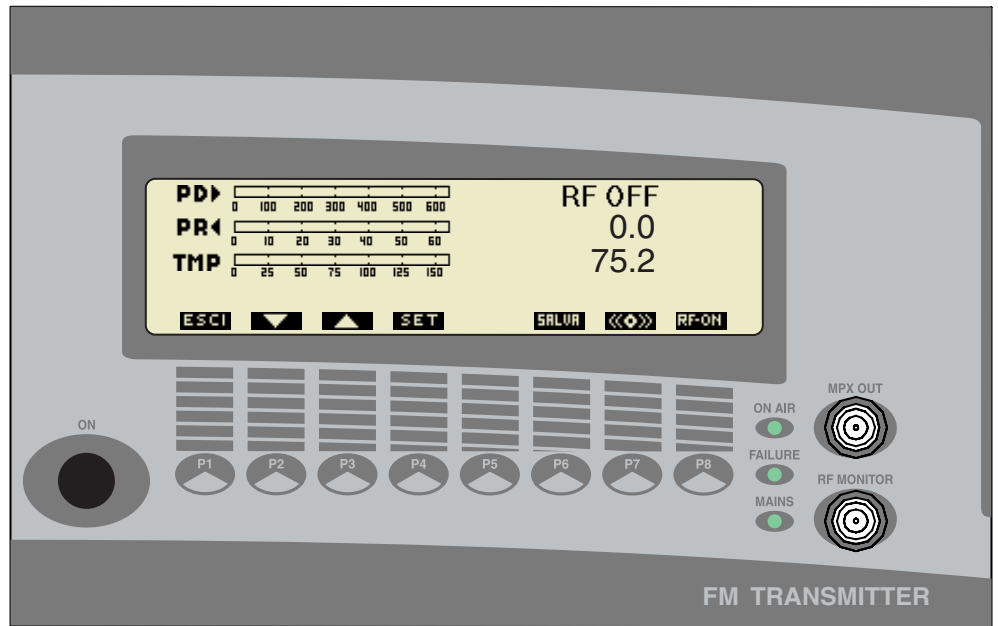

- ☞ Press key P1 to return to the functions menu
- ☞ Press key P4 to set the output power level from 0W to a maximum value of 500W
- ☞ Press key P2 to reduce the output power
- ☞ Press key P3 to increase the output power
- ☞ Press key P6 to save the adjustment made
- ☞ Press key P7 to activate or deactivate the output stage of the amplifier. For example, in the diagram, output power is disabled.

In the RF menu, the following parameters are displayed: direct power, reflected power and temperature in both “analog” and numerical form.

3.4.5. Adjustment of output frequency Frequency Menu

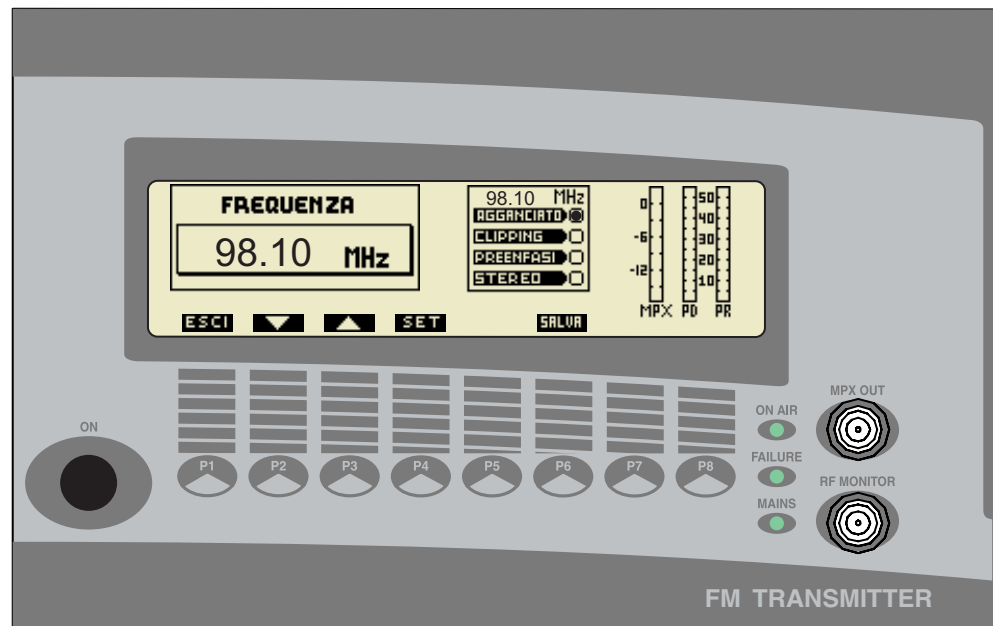

- Press key P1 to return to the functions menu
- Press key P4 to set the operating frequency
- Press key P2 to reduce the operating frequency
- Press key P3 to increase the operating frequency
- Press key P6 to save the adjustment made

The frequency menu displays the following parameters: MPX level, direct power, reflected power, operating frequency (highlighted), PLL lock, clipper operation, insertion of pre-emphasis and activation of the stereo encoder.

3.4.6.
User setup menu

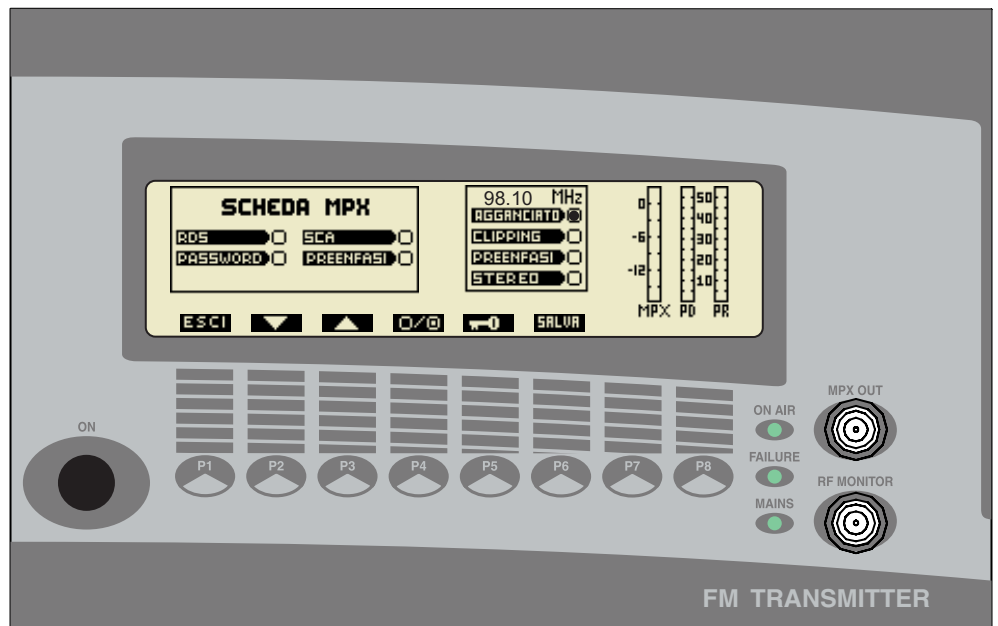

- ☞ Press key P1 to return to the functions menu
- ☞ Press key P2 to scroll the menu options from top to bottom
- ☞ Press key P3 to scroll the menu options from bottom to top
- ☞ Press key P4 to enable (circle filled) or disable (circle empty) the selected function
- ☞ Press key P6 to save the change
- ☞ Press key P5 to program a four figure password

The password restricts access to the audio, frequency, power and user setup menus by unauthorised personnel.

The following parameters are displayed in the user setup menu: MPX level, direct power, reflected power, operating frequency, PLL lock, clipper operation, insertion of pre-emphasis and activation of the stereo encoder.

3.4.7.
Timer Display

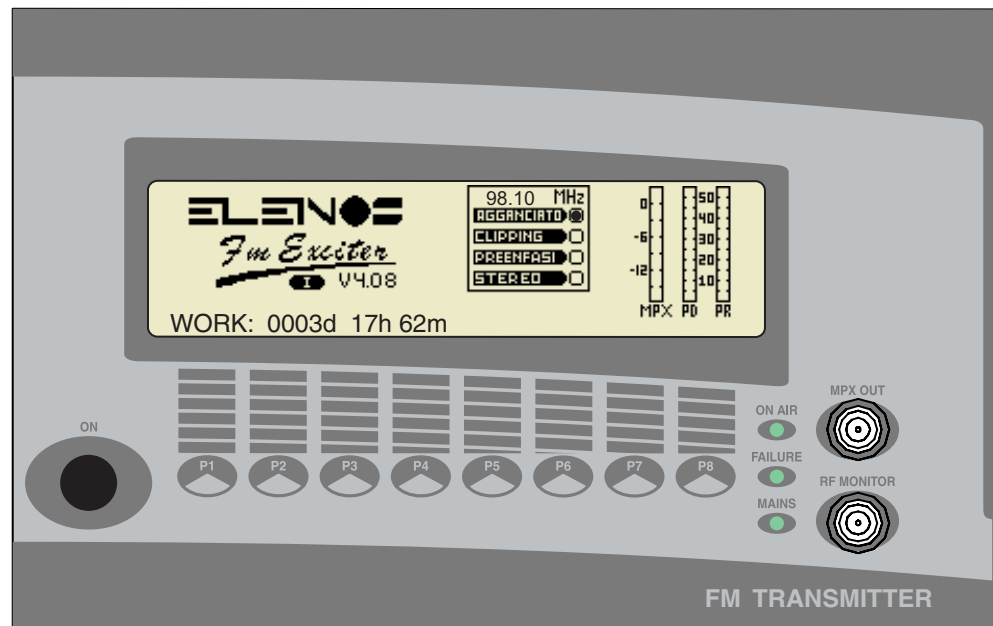

From the main menu, key P5 accesses the timer display which indicates the operating time of the unit in days (d), hours (h) and minutes (m).

3.4.8. **Adjustment of RDS settings (optional)**
RDS menu
(Optional)

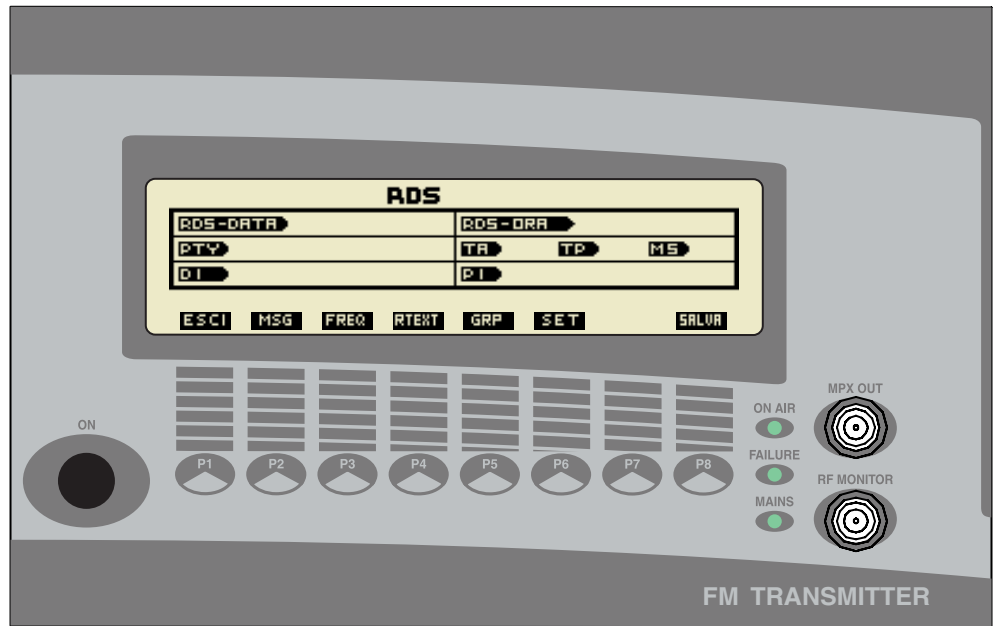

In function menu press P4 to enter RDS menu

- ☞ Press P1 to return to function menu
- ☞ Press P2 to enable RDS messaging settings
- ☞ Press P3 to enable alternative frequencies settings
- ☞ Press P4 to enable radio text settings
- ☞ Press P5 to enable groups settings
- ☞ Press P6 to set RDS Date and Time, PTY, DI, TA, TP, MS and PI
- ☞ Press P8 to save settings

3.4.8.
RDS Menu
(Optional)



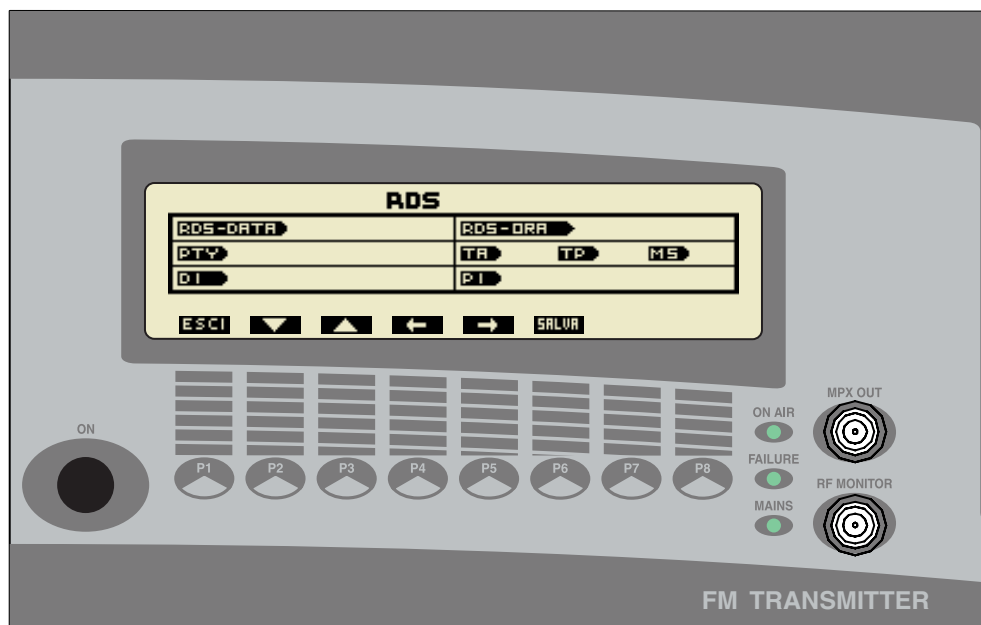

- From the RDS menu (page 21)
- Press key P6 to program RDS Date and Time, PTY, DI, TA, TP, MS and PI

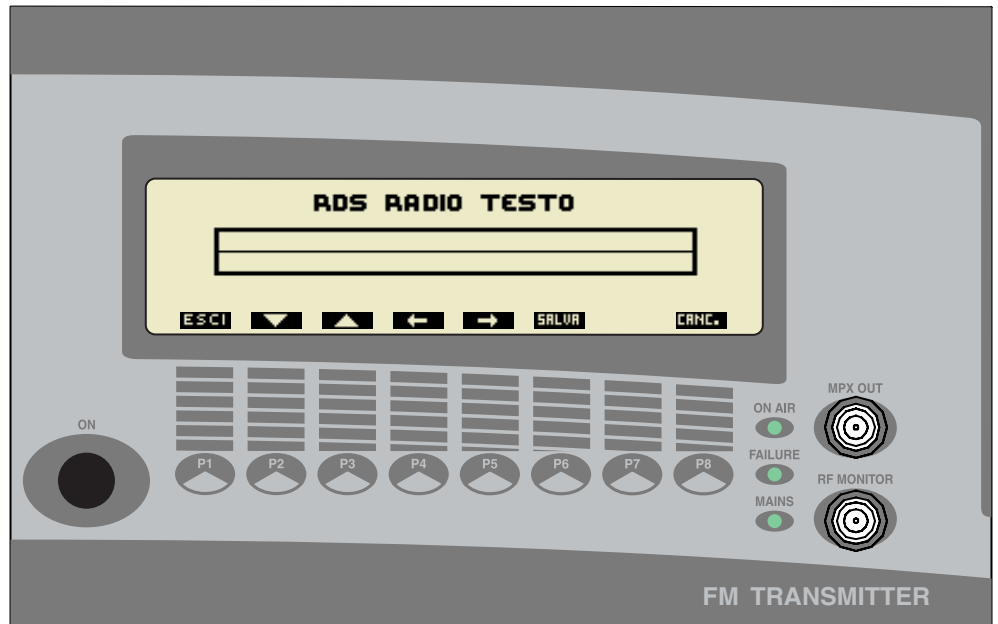

- Press key P1 to return to the main RDS menu
- Press keys P4 and P5 to select the data to modify
- Press keys P2 and P3 to select options for the selected data
- Press key P6 to save the changes made

- 3.4.8. From the RDS menu (page 21)
RDS Menu (Optional)  Press key P4 to set the RDS TEXT message



-  Press key P1 to return to the main RDS menu
-  Press keys P4 and P5 move the cursor
-  Press keys P2 and P3 to select the letter to insert
-  Press key P6 to save the changes made to the message
N.B. If unsaved, the previous message will remain unchanged
-  Press key P8 to delete the whole message

3.4.8.
RDS menu
(Optional)

- From the RDS menu (page 21)
☞ Press key P2 to display the RDS messages

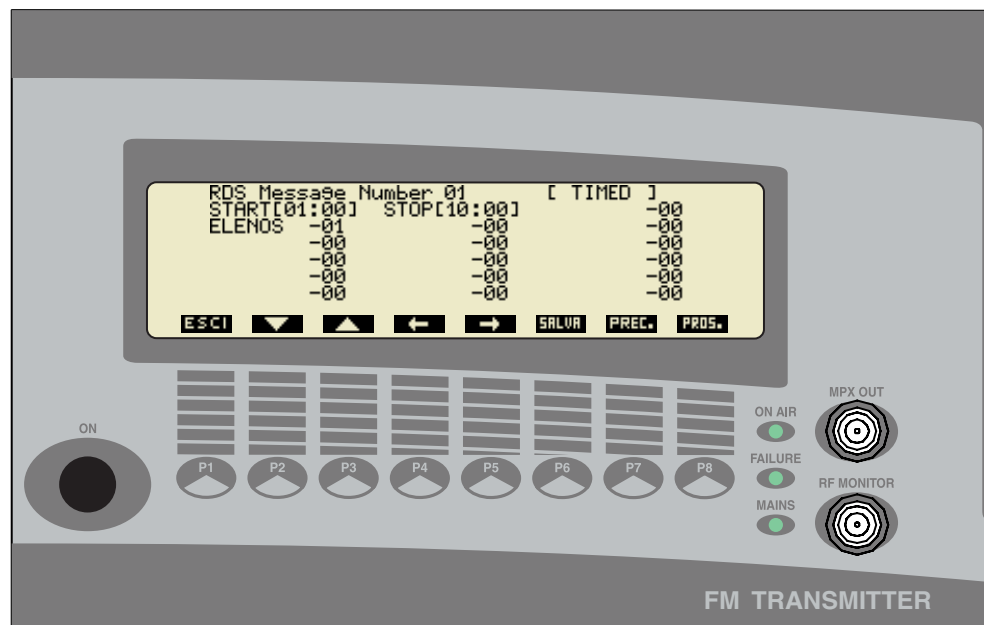

- ✓ Status display (Disable, Timed, Scroll)
- ✓ Display of START and END display time
- ✓ 16 fields comprising 8 characters each and display times in seconds

- From the RDS menu (page 21)
☞ Press key P3 to set alternative frequencies

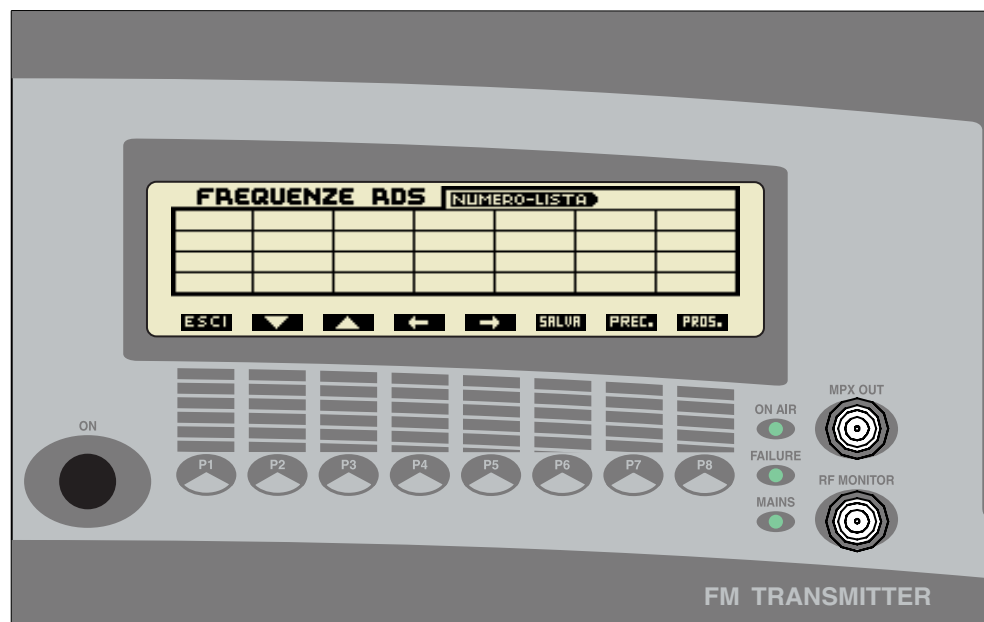

This window shows one of the sixteen lists of RDS frequencies.
The following is displayed in this window:

- ✓ Display of the list number
- ✓ Display of the type of list (A or B)
- ✓ Display of the list header (only for list type "B")
- ✓ 28 fields that can be filled with 24 frequencies of type "A" or 12 of type "B"

3.4.9.
Deviation and Statistics Menu

- From the functions menu (page 15)
- ☞ Press key P6 to display Deviation and Statistics

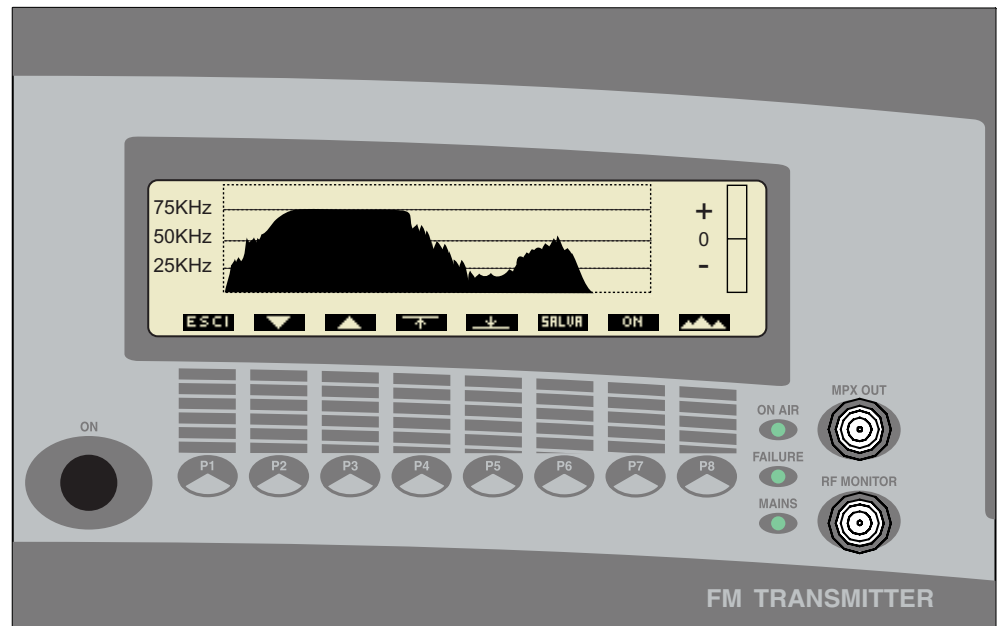

- ☞ Press key P1 to return to the main menu
- ☞ Press key P7 to enable or disable audio ALC (Automatic Level Control)
- ☞ Press key P4 * to set the upper threshold for ALC
- ☞ Press key P2 to reduce the value of the upper threshold
- ☞ Press key P3 to increase the value of the upper threshold
- ☞ Press key P6 to save the changes made
- ☞ Press key P5 * to set the lower threshold for ALC
- ☞ Press key P2 to reduce the value of the lower threshold
- ☞ Press key P3 to increase the value of the lower threshold
- ☞ Press key P6 to save the changes made

(*) Pressing keys P4 or P5 will cycle through the options to modify the threshold measured in KHz, in dB, and the response time of the Clipper in seconds.

N.B.

The status of the ALC is displayed by the right hand bar

- ☞ Press key P8 to access the statistics menu (see next page)

This window shows the absolute value of modulation (MPX) in time.
The graphics allow the modulation to be displayed over a period of several minutes of transmission.
To facilitate reading, the display is calibrated at values of 25, 50 and 75KHz.

3.4.9.
Deviation and
Statistics Menu

- From the deviation menu (page 25)
➤ Press key P8 to display Statistics

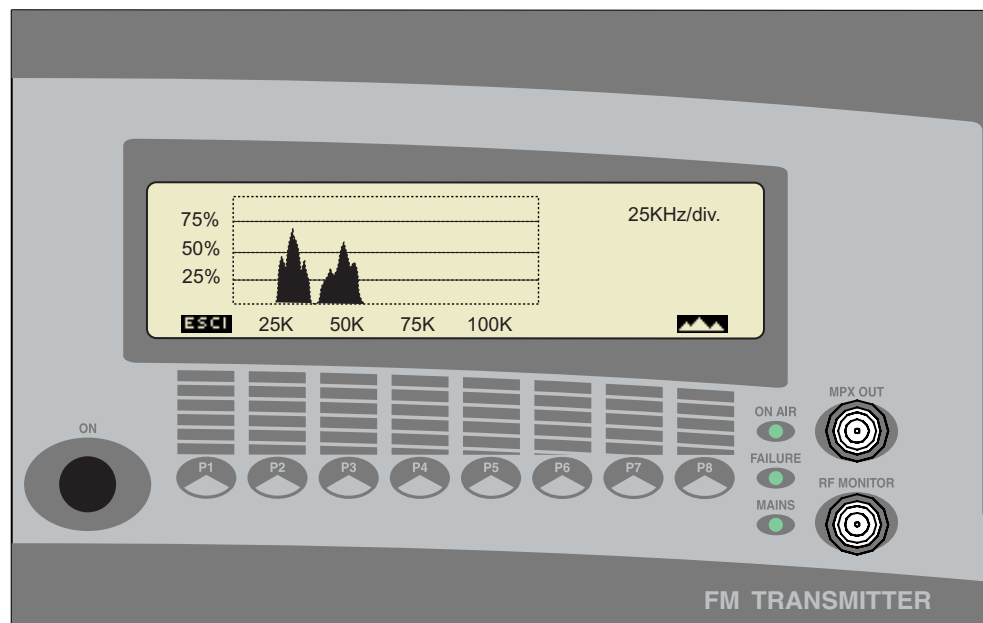

- Press key P1 to return to the main menu
➤ Press key P8 to return to the deviation menu (previous page)

This window displays the percentage modulation (MPX).
The graphics allow evaluation of how much deviation is present and the percentage exceeding 75KHz of deviation.

- Y AXIS: The grid highlights the values 0%, 25%, 75%, 100%
- X AXIS: The grid highlights deviation values 0, 25, 50, 75, 100KHz

3.4.10. RDS Encoder Programming

Each encoder is supplied with a 3.5" disk containing programming software for an IBM compatible PC.

Once installed, the software is already operational - just connect the PC to the encoder and switch it on to start programming it.

At start up a screen will appear asking whether COM1 or COM2 is used for the serial connection. A second screen will then appear, "Baud Rate Selection", which asks for the speed of the serial connection in baud. Select 2400 as the default.

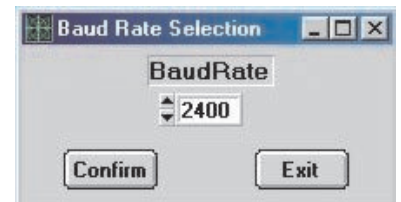

ATTENTION:

In the event that the correct serial port or baud rate has not been selected, the following message will appear:



This window will appear whenever an error is detected.

ATTENTION:

Whenever this programme is in use, ensure that you exit any ETG500 window that corresponds to RDS programming.

3.4.10.
RDS Encoder
Programming

Once the port and baud rate have been set, the PC will begin to upload encoder data to determine the data with which it has been programmed. When successfully completed, a screen will appear with three main sections: "PS Messages", "Alternative Frequencies" and "Program Identification".

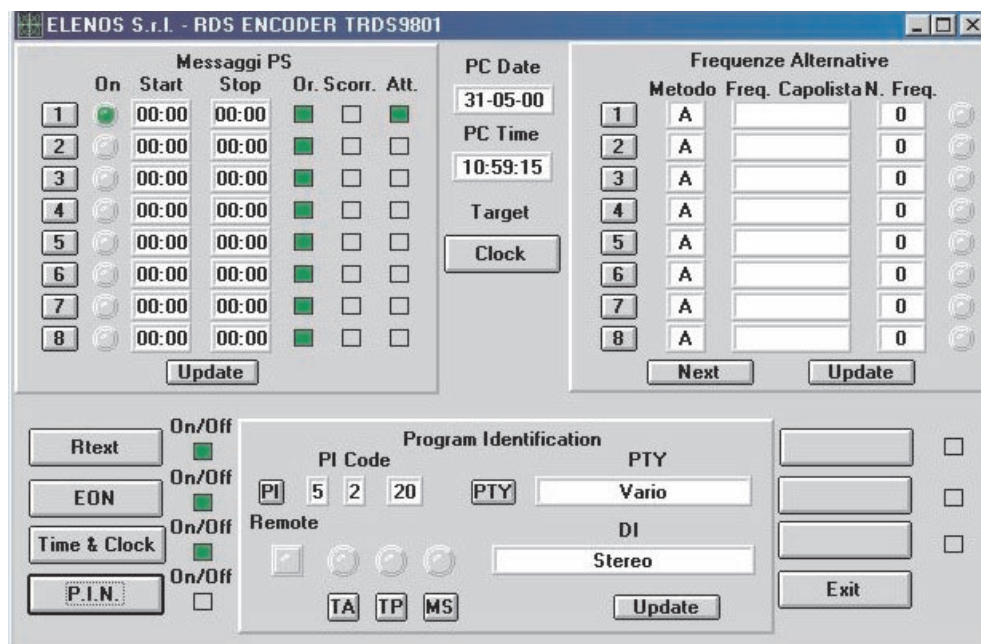

3.4.10.
RDS Encoder
Programming

PS Messages:

The "PS Messages" section shows 8 zones, each of which comprises the following fields:

- ✓ 1-8 keys to select the window for modifying the contents of the corresponding PS message.
- ✓ START text box corresponding to the time of start of transmission of the PS message. This field can only be modified if the OR key is lit.
- ✓ STOP text box corresponding to the time of the end of transmission of the PS message. This field can only be modified if the OR key is lit.
- ✓ ATT (active) key enabling the PS message to be transmitted on-air; if green, the message is on-air.
- ✓ OR (time) key enabling the on-air message to be timed; if OR and ATT are both green, the PS message will go on-air between the times specified by the START and STOP fields.
- ✓ SC (scroll) key enabling the transmission of the PS message in scrolling mode (one letter to the right every second).
- ✓ ON indicator (green) confirming that the corresponding message is on-air.

Active messages (ATT lit green) which are not timed (OR grey) will be transmitted consecutively during intervals when timed messages are inactive. To ensure that the video programming is in step with the encoder, press the "Update" key.

Procedure for programming message 1

- ☞ Press OR (time) so that it is lit green (time setting enabled)
- ☞ Click the mouse on the START window
- ☞ Delete the previous time (CANC key)
- ☞ Enter the start time (using the same format: "XX:XX")
- ☞ Click the mouse on the STOP window
- ☞ Delete the previous time (CANC key)
- ☞ Write the end time of the message
- ☞ Press key 1 (the message programming window will appear)

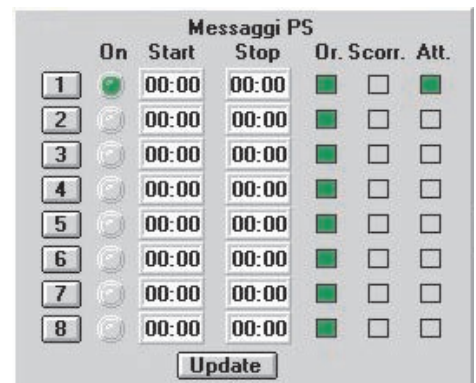

3.4.10. RDS Encoder Programming

Programming PS Messages

Having pressed one of the keys 1-8, corresponding to the number of the PS message to program, a window will appear with 16 fields for the words which make up the message, and the corresponding times for which the words will be displayed.

The times, in seconds, can be programmed from a minimum of 1 second to a maximum of 60 seconds and represent the time for which the word will be displayed before being replaced by the next word. However, if the message is programmed to scroll (the SC key is lit green in the previous window), the times displayed have no relevance.

N.B.

The fields which are left blank are not transmitted even if a display time of more than one second has been set.

Procedure for programming a message

1. Double click on the text box where a word is to be entered, and then enter the word
2. Adjust the display time of the word using the UP and DOWN arrows underneath the text box
3. Repeat steps 1 and 2 for all the other words to be programmed
4. Press the UPDATE key to save the message and exit from the window

Alternatively, press the EXIT key to exit from the window without saving the message

From the main window:

5. Press the ATT key (activate the message)
6. Press the UPDATE key to update (the green ON indicator will light to show the message is active)
7. It is now possible to insert other messages (upto 8) following the same procedure



3.4.10. **Alternative frequencies**
RDS Encoder
Programming

The Alternative frequencies section allows 16 lists of different frequencies to be programmed, each in mode A or B. 8 lists are displayed at a time and with each one, the mode (A or B) with which it was programmed, the header frequency (this field is filled only if mode B has been used) and the number of frequencies in the list. To access a list just click the corresponding key with the mouse; a display will appear showing the mode and the list of possible frequencies on the left, and the frequencies in the list on the right. Double-click on a frequency contained in the left-hand list and it will be added, if not already present, to the list on the right. With mode A, it is possible to create a list with a maximum of 25 frequencies compared with 12 in mode B.

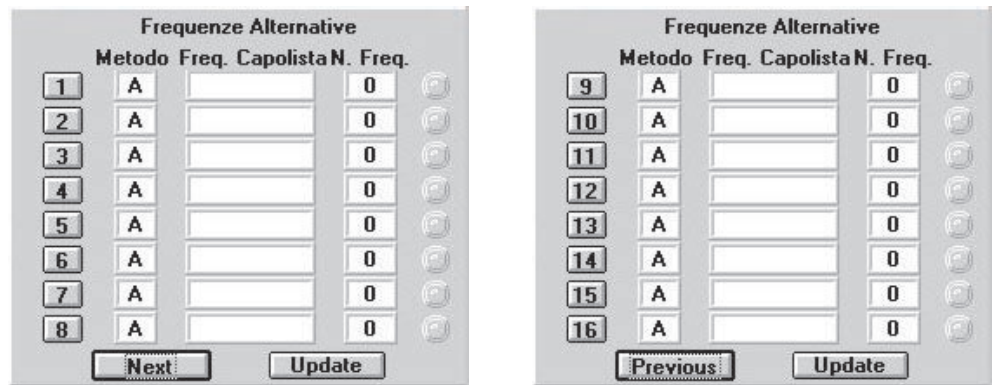

Method A/B

The EBU standard allows for the possibility of transmitting the set of frequencies to a network of transmitters in two modes, A and B.

- Method A allows transmission of one or more lists of frequencies, each upto a maximum of 25.
- Method B allows transmission of as many lists as there are transmitters in the network

Each list is headed with the frequency of the transmitter to which it corresponds and contains all the frequencies of adjacent transmitters.

Each receiver is designed to store a certain number of alternative frequencies which will be searched automatically for a new frequency when the current signal is too weak to receive. The search is as fast as the list of alternative frequencies is short. When the number of transmitters exceeds 12, it is advisable to use method B in which the receiver stores only the list corresponding to the header frequency to which it is tuned, so facilitating a faster change of frequency.

3.4.10.
RDS Encoder
Programming

Programming alternative frequencies

To correctly program alternative frequencies, follow the instructions in sequence:

1. From the main menu, click on the key corresponding to the list to program.
2. Select method A or B.
3. Scroll the list of frequencies and double-click the mouse on the desired frequency. The data will be inserted in the selected list of frequencies (right-hand list). With method B selected, the first selected frequency is the header frequency and appears in the relevant window. To delete any stored frequency, double-click on it with the mouse.
4. To save the selection, click on USCITA.
5. In the main menu a green indicator will appear to the left of the list being modified or programmed to show that data is being changed. Click the UPDATE key to store the new data in the RDS board.

At this point, further alternative frequencies may be programmed.

Esempi

Metodo A

Metodo B



Program identification

In this section parameters specific to the broadcaster are programmed; Program Identification, Program Type, Decoder Identification, Traffic Announcement, Traffic Program and Music/Speech.

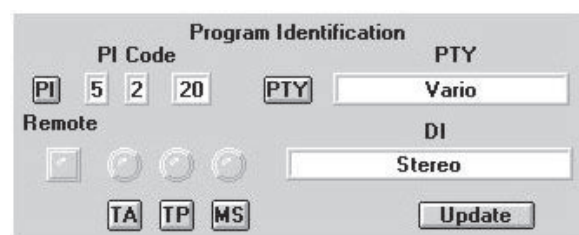

3.4.10.
RDS Encoder
Programming

Program identification PI

PI is an identification code comprising 3 fields: COUNTRY + DIFFUSIONE + CODE.

COUNTRY is a numerical value from 0 to 15 (0,F in hexadecimal) which identifies the country of the broadcaster (Italy - code 5).

DIFFUSIONE is a numerical value from 0 to 15 (0,F in hexadecimal) which identifies the area of coverage of the broadcast signal (local, regional, national, international).

CODE is a numerical value from 0 to 255 (00,FF in hexadecimal) which identifies the broadcaster; the code is assigned by an authorised organisation.

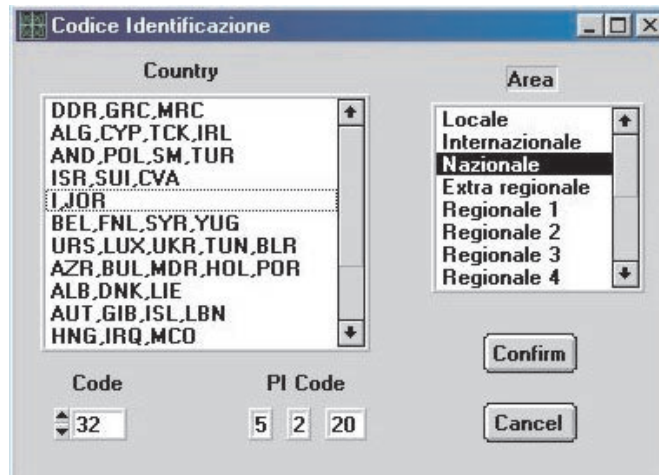

1. To program PI just click on the corresponding key with the mouse.
2. Double-clicking on the item will automatically enable the relevant codes.
3. Press the CONFIRM key to confirm the choice.
4. To exit without saving, press CANCEL

Program Type and Decoder Identification DI

PTY is a code with 32 values (from 0 to 31) which identifies the type of transmission being broadcast.

DI identifies 16 different operational modes that the broadcaster can use.

- Click the PTY key with the mouse to start programming
- To store the selection, press UPDATE.
- To exit without saving, press EXIT.

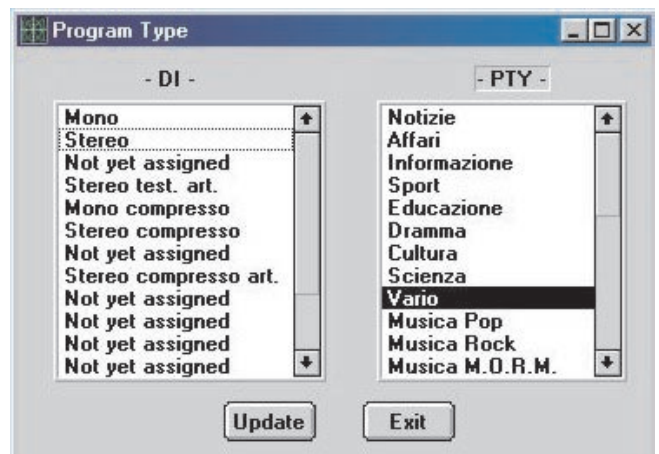

3.4.10. **TA-TP-MS**
RDS Encoder
Programming

At any time during the day, the broadcaster can interrupt the programme being transmitted with traffic news; for this reason the standard provides for a number of flags which indicate to the receiver that this information is being transmitted so that automatic tuning and/or volume adjustment can be made. These flags are named TA, TP and MS.

- ✓ The TP flag identifies the broadcaster which is making traffic announcements
- ✓ The TA defines the time intervals between traffic announcements.
- ✓ The MS flag indicates whether the transmission is of Music or Speech (Voice)

These flags can be set by clicking the mouse on the relevant keys or via a remote keyboard connected to the appropriate board connector. If the remote keyboard is connected, the "Remote" key will be lit green and setup via a PC will be inhibited.

If the colour of the TA, TP and MS keys do not agree with the encoder leds immediately above, this means that the flags set on the screen do not match those of the encoder. To update them press the Update key.

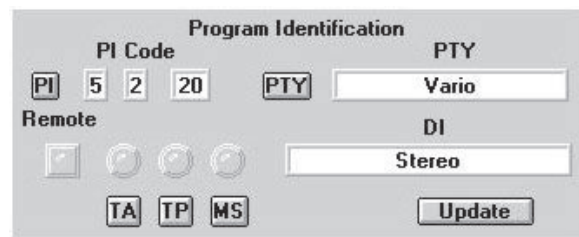

Radio Text

Radio Text is a message with a maximum length of 64 characters used to check the quality of the signal within the coverage area. The message is transmitted indefinitely

To program the message, click the mouse on the RTEXT key.
To activate the message, click the mouse on the adjacent ON/OFF key.



3.4.10. **EON Message** RDS Encoder Programming

The EON message is used when a broadcaster has an agreement with another broadcaster (that we shall call "Friend") to permit automatic tuning of receivers to Radio Friend, in areas where the signal quality of the broadcaster is poor or absent, or when Radio Friend is broadcasting information of interest to the listener.

RDS allows programming of data upto a maximum of 8 partner broadcasters. Each broadcast network is a broadcaster in its own right and must therefore have unique identification of its data and allow all common services of interest identifiable between the two broadcasters.



Programming access to all this data is enabled by clicking the EON key located on the left side of the main panel; this displays the list of 8 networks that can be programmed.

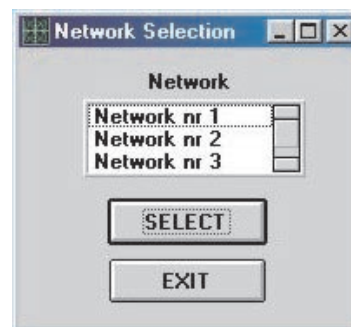

Having chosen a network, a screen is displayed which shows all the parameters to be programmed: PI-PS-TA-TP-PTY-AF-PIN

- ✓ PI is the identification code of radio Friend.
- ✓ PS is the 8 character message which is displayed on receivers tuned to the radio Friend frequencies.
- ✓ TP indicates that the Friend broadcaster is enabled to transmit traffic news.
- ✓ TA indicates that the Friend broadcaster is transmitting traffic announcements.
- ✓ PTY indicates the type of programme.
- ✓ AF indicates the list of alternative frequencies on which radio Friend can be received.

3.4.10. RDS Encoder Programming

The method of programming is similar to that of the main broadcaster (see previous pages). For each network it is possible to program a maximum of 7 frequencies with method A and 4 frequencies with method B.

To enable transmission of the programmed data for each network, just press the "Message Active" key; if it is coloured green, this means that the data is valid and may be transmitted.

ATTENTION: data relating to active networks (those for which the "Message Active" is green) are transmitted even if the ON/OFF key on the main panel is set (green).

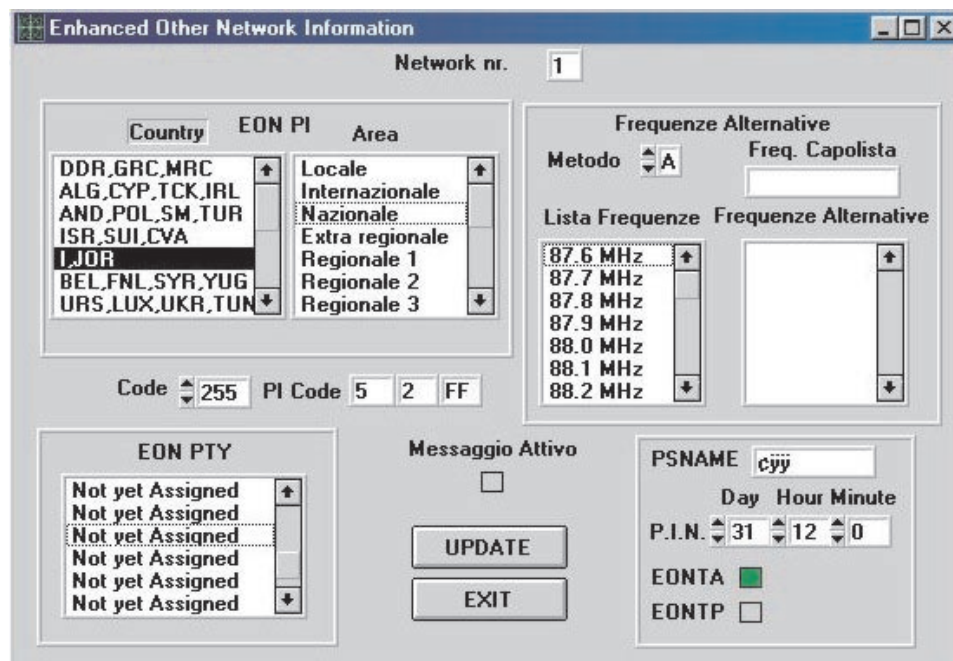

Time & Clock Data

The RDS encoder has an on-board clock-calendar which provides an autonomous timing function. The clock-calendar can be read and updated so that listener's receivers can be synchronised. When this message is transmitted, the encoder sends a data packet containing the date and time referred to the Greenwich meridian on every change of minute. The time difference is expressed in half-hour steps.

To synchronise the clock-calendar to the actual date and time:

1. Press the CLOCK key or the TIME&C key

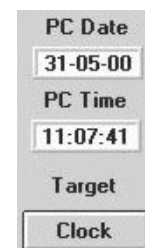

3.4.10.
*RDS Encoder
Programming*

2. Double-click on the TARGET TIME box and enter the time local to where the broadcaster is transmitting.
3. Double click on the TARGET DATE box and enter the date.
4. Select the location with respect to Greenwich (the RDS system is able to update the time according to the country in which it is transmitting).
5. Press the UPDATE key to transfer the data to the encoder.

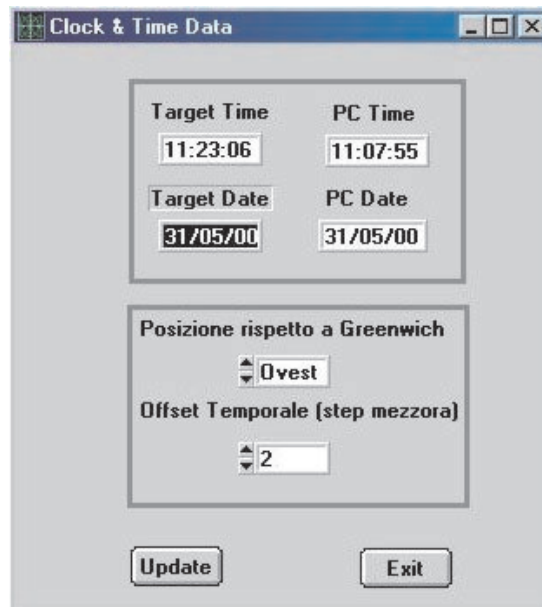

If the EXIT key is pressed, the clock-calendar will not be changed.

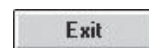

Once the programming is complete, the PC can be disconnected and used for other purposes. Clicking the mouse on the EXIT key will terminate programming of the encoder.

3.4.10.
RDS Encoder
Programming

Technical data

RDS SIGNAL	as per CENELEC EN50067
ENCODING	2 level differential
MODULATION	DSB suppressed carrier
FREQUENCY	57 KHz
BAND	+/- 2.4 KHz
INPUT MPX	0/+12 dBm into 600 Ohms
OUTPUT	MPX+RDS
MPX OUTPUT LEVEL	Inp. MPX
RDS OUTPUT LEVEL	20 - 150 mV RMS
OUTPUT IMPEDANCE	100 Ohms
PS MESSAGES	8 with 16 words of 8 characters
ALTERNATIVE	16 with maximum 250 frequencies each
FREQUENCY LISTS	
MESSAGE	With IBM compatible PC
PROGRAMMING	
CONNECTION	RS232-C Standard
COMMUNICATION	Full Duplex
SPEED	2400 baud
CONNECTORS	9 Pin Cannon Female
.....	9 Pin Cannon Male
.....	BNC
MESSAGE MANAGEMENT	Microcontroller
DATA BACKUP	10 years
OPERATING TEMPERATURE...	0 - 55 °C
POWER SUPPLY	+12Vdc 100mA, +5Vdc 800mA

3.5. Checking performance

This procedure for checking performance should be carried out if there is any doubt over the integrity of the unit or possible damage sustained during transport. It should be performed by expert personnel capable of operating radiofrequency measurement equipment.

The unit is calibrated using an FMAB modulation analyser (R&S) and so the performance checking equipment must be high precision, analogue instrumentation.

Power developed Connect a high quality wattmeter (e.g. Bird mod. 43) to the unit, via a double, male N-type connector. The wattmeter output is connected to a high quality dummy load (SWR less than 1.05) capable of dissipating at least 500W continuously via a 50 Ohm coaxial cable of appropriate cross section (e.g. RG213). Adjust the maximum range of the wattmeter to correspond to the power generated (e.g. for a Bird mod. 43 wattmeter, use a 500W probe adjusted to measure direct power). Power up the unit and check that the power shown on the display corresponds to the power displayed by the wattmeter. There is a tolerance of upto 25W difference between the two.
It is of the utmost importance to use a wattmeter that is performing to its high precision specification.
The measurement will be invalid if the wattmeter is connected to the unit via a coaxial cable without the double connector as specified.

Programmed frequency Connect the unit to a dummy load with a -30dB output capable of dissipating at least 500W of continuous power, via a 50 Ohm coaxial cable of appropriate section (e.g. RG213). Connect the output of the dummy load, attenuated by another 20dB, to a frequency meter which is known to be performing to its high-precision specification. Power up the unit and check that the frequency shown on the display corresponds to the frequency displayed by the frequency meter. There is a tolerance of upto 100Hz difference between the two readings.

Deviation Connect the unit to a dummy load with a -30dB output capable of dissipating at least 500W of continuous power, with a coaxial cable of appropriate section (e.g. RG213). Connect the output of the dummy load, attenuated by another 20dB to a modulation analyser which is known to be performing to its high-precision specification. Connect the MPX input to a 1KHz sinusoidal signal from a low-frequency signal generator, with the amplitude adjusted for a level of 0dBm. Power up the unit and check that the deviation displayed by the unit and by the modulation analyser fall within the range 75KHz -0.2dB and 75 KHz.

4.1.
Introduction



This technical manual contains information regarding the operation, use and maintenance of the ETG101 (151) exciter.

The ETG101 (151) operates in the frequency band from 87.5MHz to 108MHz in steps of 10KHz and is capable of developing a maximum, continuous power of 100W (150 W).

All the operating controls of the unit are directly accessible from the front panel whilst all the connectors are available on the rear panel.

The connectors for measurement of signals are however located on the front panel.

The exciter can be used for monophonic, stereo and composite multiplex transmissions.

4.2.
Using the
block diagram

The block diagram describing the ETG101 (151) exciter is on the following page.

The principle of communication between the various boards is clear from their interconnection; each connection is identified by a progressive number within a circle. In the pages following the block diagram where individual boards are described, the cable loom numbers are identified in order to simplify maintenance and eventual repair.

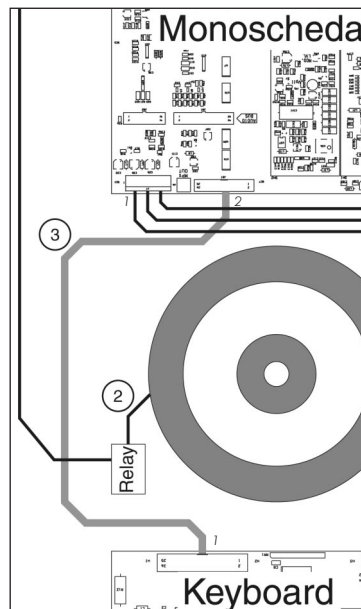

In this case, for example, the board is connected to the keyboard via flat 3, and the transformer is connected to the relay via cable 2 etc.

In the board descriptions following the block diagram, the following information appears:

Connections:

- 1 (JD1) via cable flat 3 to 1 (J1) of the monoboard

The first number is a reference whilst the number in brackets represents the name of the connector of the board in question.

For more detail, see the layouts of the schematics.

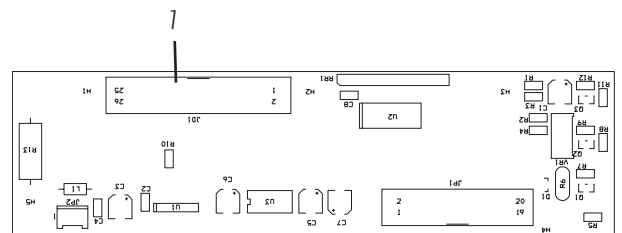

Pag 1 file A3

4.4.
Power supply section

The ETG101 (151) uses a switch-mode converter.
The ETG101 (151) exciter features a line filter fitted to the alternating supply to provide maximum suppression of conducted interference.
The use of discrete component technology enables easy replacement in the event of failure.

4.4.1.
Service power supply

The service (or auxiliary) power supply furnishes 5 separate supplies which supply the various boards which go to make up the unit.
The table below summarises the supply voltages for each section of the unit and the corresponding protection.

The service (or auxiliary) power supply is a linear type in order to reduce to a minimum any disturbances that could interfere with the boards.

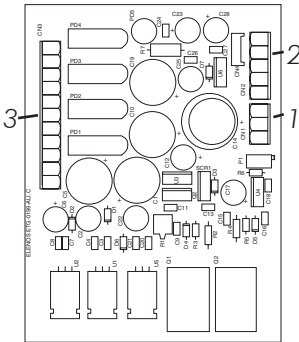

Supply Voltage	Boards supplied	Protection
+ 12V	Mother board (CPU, PLL, BUS)	Current protection
-12V	Mother board (CPU, PLL, BUS)	Current protection
+5V	Mother board (CPU, PLL, BUS)	Current and voltage protection
+ 12V _{RF}	RF driver stage	Current protection
+ 18V _{RF}	RF driver stage	Current protection

Connections:

- 1 (CN1) via cable 19 to 2 to the "DRIVER" board
- 2 (CN2) via cable 4 to 1 (J1) of the mother board
- 3 (CN3) via cable 7 to the transformer

4.5. Radiofrequency section

This comprises a low power output stage (driver) connected to the final power stage.

The power output from the module supplies the input of the low-pass filter. The measurement probe which is located on the final part of the low-pass filter, reads the values of direct and reflected power for the CPU.

4.5.1. Driver

The driver comprises an input stage of about 10mW and supplies a maximum output power of 15W.

It is built using a mix of technologies and subdivided into three main amplifying stages.

The first stage is a "MMIC" type "ERA5".

The second stage is a MOS BLF404.

The third stage is a MOS BLF244.

The output of the driver is connected to the input of the RF module.

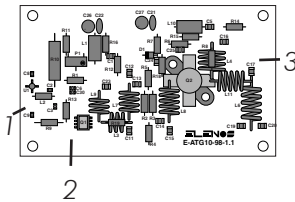

Connections:

- 1 via coaxial cable 10 to 3 (J8 RF OUT) of the mother board
- 2 via cable 19 to 1 (CN1) of the services power supply (auxiliary)
- 3 via coaxial cable 14 to 1 of the "RF module"

4.5.2. RF Modules

The module comprises a MOSFET (BLF278) and is capable of delivering a maximum power of 100 (150) W.

The gates are controlled by the CPU so that power output can be inhibited when the user changes frequency.

The output of the module enters the low-pass filter.

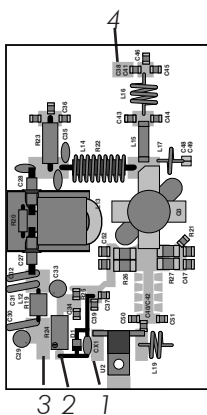

Connections:

- 1 via coaxial cables 14 to 3 of the driver
- 2 via cable 6 to 1 (J1) of the mother board
- 3 via cable 18 to capacitors board
- 4 via coaxial cable 17 to 2 of the low-pass filter (LPF INPUT)

4.5.3.
Low-pass filter
RF Out

This is a ninth order "CHEBYCHEV" filter, with teflon support. It guarantees the suppression of harmonic components with the limits set by International standards.

Connections:

- 1 (JP1) via flat cable 11 to 5 (CN1) of the mother board
- 2 via coaxial cable 17 to 4 of the RF Module

"RF Out" indicates the RF power output connector which is located on the rear panel

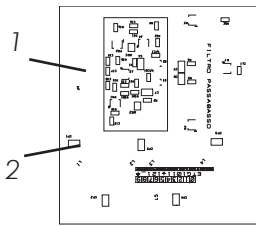

4.5.4.1.
Directional coupler
Output power measurement

The directional coupler is located on the final output stage of the low-pass filter. It is designed using SMD technology and is shielded to prevent RF interference. It generates a voltage proportional to the direct and reflected power.

Connections:

- 1 (JP1) via flat cable 11 to 5 (CN1) of the mother board

N.B.

The directional coupler is mounted on the same circuit board.

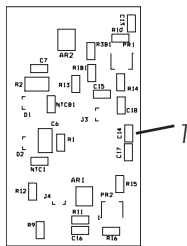

4.5.4.2.
Directional coupler
AGC protection

A control circuit regulates the output power and maintains it to within +0.1dB across the whole operating band, progressively reducing it down to 50W in the event of excessive SWR. This enables the exciter to continue to work with infinite SWR at any phase angle.

4.6.
Logic
(Mother board)

This board is constructed using only SMD technology and comprises the following stages:

- CPU
- AGC
- VCO/PLL
- MPX

Connections:

- 1 (J1) via cable 4 to 2 (CN2) of the services (auxiliary) power supply
- 1 (J1) via cable 6 to 2 of the RF Module
- 2 (JD1) via cable flat 3 to 1 (JD1) of the Keyboard
- 3 (SC1) via coaxial cable 10 to 1 of the Driver
- 4 (CN2) via cable 12 to the temperature sensor
- 5 (CN1) via cable flat 11 to 1 of the directional coupler

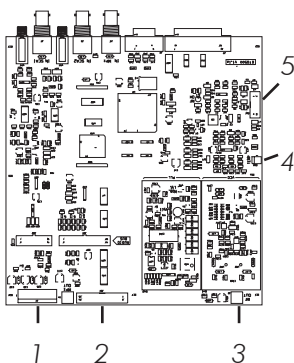

4.6.1. CPU
The CPU controls the display, the keyboard, ALC and the VCO/PLL. It comprises an 80C552 microprocessor which operates at a clock rate of 16MHz.
It features a 256 Kbit RAM and a 2Mbit ROM.
It receives input signals from the directional coupler and supplies processed signals to the ALC.
It also controls all the audio functions.

4.6.2. ALC
This receives signals from the CPU and supplies 2 output voltages:
1) Controls the MOS gates
2) Controls the output voltage of the power supply.
It features SWR protection which limits the output power in the event of an SWR in excess of the programmed threshold.

4.6.3. VCO/PLL
The PLL board generates the frequency-modulated RF signal using phase-lock synthesis.
The oscillator, controlled by the VCO voltage and mounted next to the PLL board, uses very low-noise components and also separation stages to obtain very low phase noise.
The reference frequency is generated by a temperature-compensated oscillator with a maximum drift of 1ppm.

4.6.4. MPX
Accepts the wide-band MPX input signal, i.e. it supplies the transmitter with a stereo signal derived from an external stereo encoder. It features 2 SCA inputs, one of which can be used as an RDS data input.
The two unbalanced inputs for SCA signals accept input frequencies upto 200 KHz. The MPX also supplies the microcontroller with an appropriately processed MPX signal so that the level can be displayed as a bar graph and in dBV values. The inputs are protected against over-voltage.
The inputs are unbalanced on BNC connectors (impedance 10KOhm).

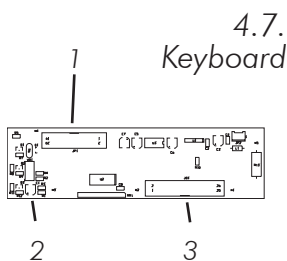

4.7. Keyboard
This is interfaced to the CPU and supplies signals to the display as well as power for illumination.
A trimmer allows adjustment of the contrast.
8 soft keys perform functions shown on the display.

- Connections:
- 1 (JP1) via flat cable 3 to 2 (JD1) of the mother board
 - 2 via cable 8 to the display
 - 3 (JD1) via flat cable 9 to the display

4.8. *Optional boards* The optional boards offer extra facilities required by customers and are simply fitted by inserting them into the relevant slots, described on page 7 of this manual, with the unit switched off.

4.8.1. *Stereo Input Board*

This board comprises two modules:

- Inputs
- Clipper

Inserted into the slot indicated on page 7, it has the function of processing the audio signal for stereophonic transmission. The board also supplies the processed stereo signal to the microcontroller which displays stereo levels using a bar graph and values expressed in dBu. The input connectors are balanced, XLR type (see the connection diagram below).

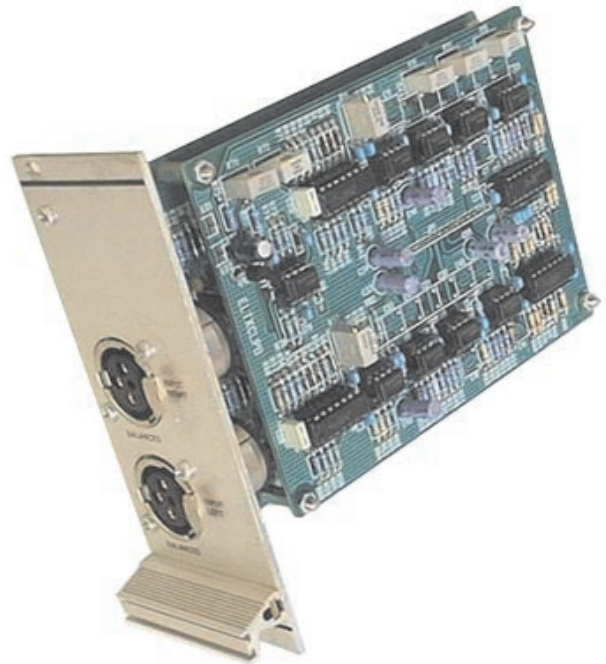

Adjustments:

- ☒ selection (jumper) of the value of pre-emphasis (50/75 usec)
- ☒ ON/OFF (jumper) of pre-emphasis
- ☒ ON/OFF (software) of pre-emphasis, of the clipper and of the filter
- ☒ adjustment (software) of the level in steps of 0.5dB on each channel
- ☒ selection (jumper) of the input impedance value (600Ohm/10KOhm)

Linea bilanciata

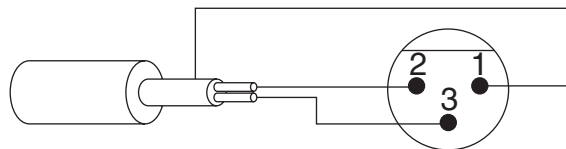

Piedino 1: massa
Piedino 2: positivo
Piedino 3: invertente

Linea sbilanciata

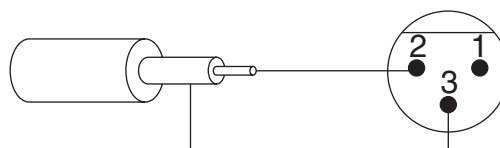

4.8.2. Stereo Encoder Board

This board digitally generates the 19 KHz pilot carrier and the suppressed carrier. It fits in the slot indicated on page 7. It features a BNC connector for supplying the signal to other transmitters.



Adjustments:

- ☞ adjustment (trimmer) of the pilot tone (8-12%)
- ☞ adjustment (trimmer) of the MPX signal clipper threshold before being added to the pilot carrier
- ☞ ON/OFF (jumper) of the clipper
- ☞ adjustment (trimmer) of the MPX level on the output of the board
- ☞ adjustment (trimmer) of the phase of the pilot tone with respect to the suppressed carrier
- ☞ adjustment (2 trimmers) of the equaliser of the sum of the signals (L+R) to obtain maximum separation
- ☞ adjustment (trimmer) of the suppressed carrier level (greater than 90 dB)
- ☞ ON/OFF (software) of the clipper
- ☞ ON/OFF (software) of the pilot carrier
- ☞ selection (software) stereo/mono

Technical data

PRE-EMPHASIS	50/75 us +/-0.1dB
FREQUENCY RESPONSE	+/-0.15dB (30Hz - 15KHz)
STEREO SEPARATION	typically 65dB @ 1KHz
PILOT TONE	Frequency: 19KHz +/- 1Hz deviation 7.5KHz adjustable
AUDIO INPUT MODULE L/R	Input impedance: 10KOhm - 600Ohm (selectable) balanced input Frequency response: 20Hz - 15KHz Adjustment: -12 - +12dB in steps of 0.1dB Connector: XLR female
ATTENUATION AT 19KHz	45dB

4.8.3. RDS Board

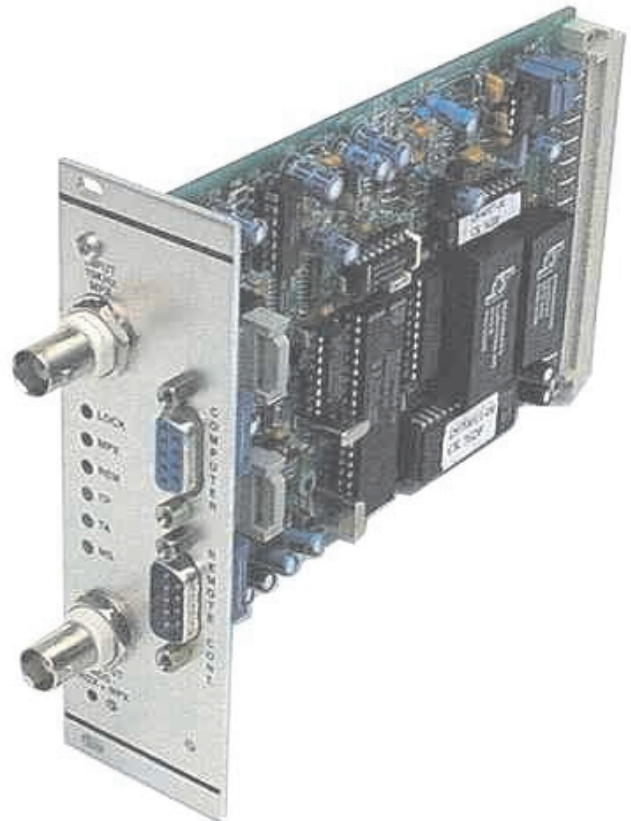

Introduction

For several years now, within the field of radio broadcasting, the importance of transmitting data packets of various types, over and above the radio signal, has been recognised as crucial to improving the quality and reliability of the services offered, let alone implementing new ones.

This need was acknowledged at international level and a study group was given a mandate to identify the various needs and define a transmission standard which is suitable for the sector.

The group created the RADIO DATA SYSTEM (RDS) which is now the most diffuse system of data transmission in the radiophonic sector.

The optional RDS board fits in the slot indicated on page 7 of this technical manual.

The ETG101's (ETG151's) optional RDS board allows a data channel to be transmitted alongside the radiophonic signal (mono or stereo), in conformity with the "Specification of the radio data system (RDS)" document, published by the European Committee for Electrotechnical Standardization (CENELEC) Ref. NO. EN50067:1990.

RDS system

The RADIO-DATA-SYSTEM (RDS) has been specified for the transmission of information within mono/stereophonic programmes in the VHF/MF (87.5-108MHz) band, thus satisfying the requirements for transmission of additional data in radiophonic programmes.

- > Compatibility with actual mono/stereophonic programmes
- > Absence of interference between adjacent channels
- > Compatibility with other existing systems of identification

4.8.3. RDS board

The system, selected by an international working group of specialists, allows data transmission at a speed of 1187.5 bit/sec with phase modulation at two levels, 57KHz carrier and band +/- 2KHz. The transmitted binary signal undergoes differential encoding.

The transmission protocol comprises packets of 104 bit (87.6ms) length, named GROUPS, each comprising 4 BLOCKS of 26 bits each. Each BLOCK is made up of 16 bits of information and 10 protection bits, designed specifically to allow words to be corrected upto a maximum of 5 bit in error. 16 distinct GROUPS are provided, some of which have not yet been defined. Each group starts with an identification code (PI) which has the double scope of synchronising the receiver and identifying the broadcaster that is transmitting the signal. The PI comprises a 4 bit code to identify the country (Italy is code 5), a 4 bit code to define the coverage of the transmitted signal (International, National, Sub-National, Regional or Local) and an 8 bit code for the number of reference of the program.

The Zero GROUP is used for sending the PS message (shown on the display of RDS compatible receivers) and for tuning frequencies. Each Zero group contains 2 characters of the message, two tuning frequencies, a code which defines the type of transmission (mono, stereo, compressed, etc.), a bit to define whether music or speech is being transmitted and a code for signalling the transmission of traffic news.

Two formats are provided for the transmission of alternative frequencies:

- A) Each station transmits a unique list of frequencies, preceded by the number of frequencies that it contains (max 24);
- B) Each station transmits a unique list of frequencies for each transmitter that it possesses. The list begins with the header frequency, followed by the frequencies (max 12) used by adjacent transmitters in the coverage area. This method is more efficient when the list of frequencies is long because it presents the self-tuning system with fewer frequencies to choose from and thus speed up the process of searching for new frequencies. If the number of frequencies is low, mode A is advised as it requires less data to be transmitted.

RDS system

The RDS encoder comprises a single Euro card offering the following features:

- ✓ Connector 41612 which accepts the power supply voltages +5V and +12V
- ✓ BNC for the input of the mono or stereo signal
- ✓ BNC for the output of the MPX signal and/or MPX+RDS
- ✓ Cannon connector 9 PIN for serial connection to a PC
- ✓ Cannon connector 9 PIN for connection of a remote keyboard
- ✓ A panel-mounted trimmer for adjusting the RDS signal level
- ✓ Led indicator, for lock and carrier generation RDS (LOCK)
- ✓ Led indicator, for synchronisation with stereo carrier (STEREO)
- ✓ Led indicator for remote control active (REM)
- ✓ Led indicator for TP set (TP)
- ✓ Led indicator for TA set (TA)
- ✓ Led indicator for MS set (MS)



4.8.3.
RDS board

The board is equipped with DB25-type female to DB9-type male cable, which can be replaced by a DB9 female to DB9 male cable (see diagram below), plus a 3.5" floppy with software for correctly programming the RDS.

N.B.
The software supplied is Microsoft Windows (c) compatible.

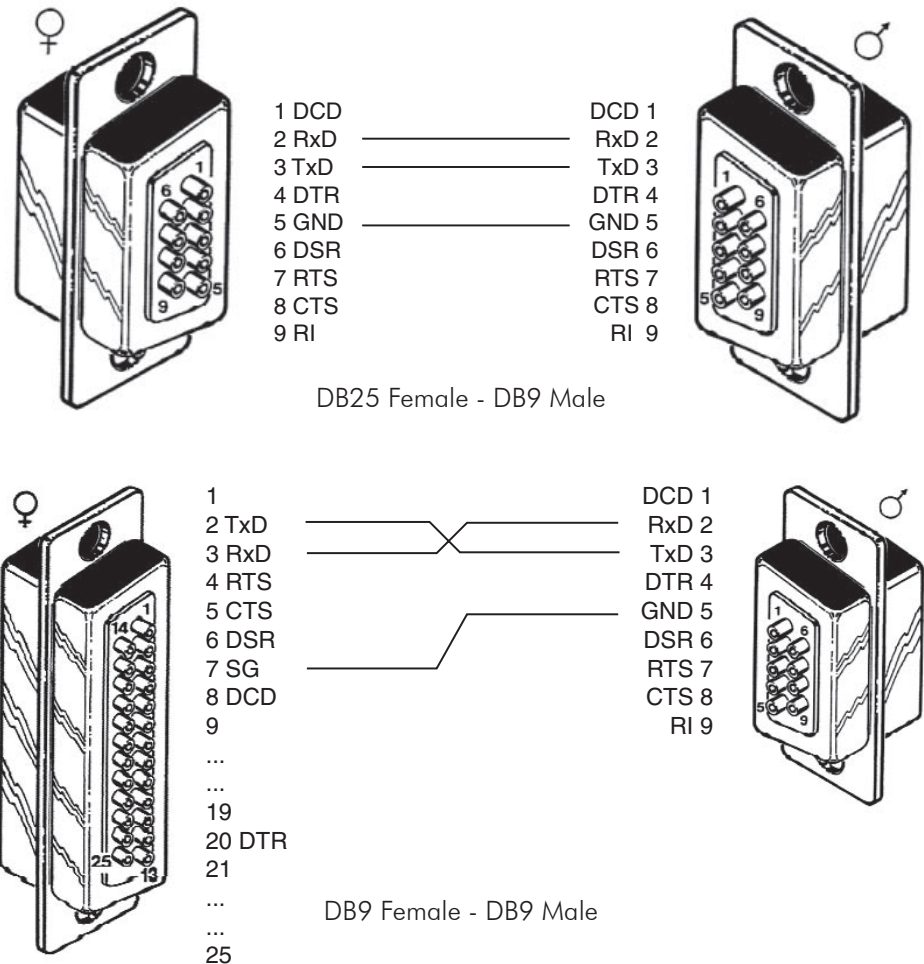

The board features a microcontroller which controls the RDS message generation.

The services supported by the encoder are programmed via a PC connected to the serial interface, running an easy-to-use program. Once programmed, the RDS messages are saved, even in the absence of primary power.

The board is equipped with a timer-calendar which updates the date and time even when no external power is present.

The RDS carrier is generated internally by a quartz oscillator, but when a 19KHz carrier is applied to the MPX1 IN input, whose amplitude, stability and frequency conform with the specification, the encoder locks to the external frequency and generates the 57 KHz synchronised to it (STEREO led lit). Thanks to the microcontroller, the encoder can modify the transmitted message in real time which makes the system extremely flexible and adaptable to the various customer requirements.

The software supplied allows programming of a set of 8 distinct PS Messages each comprising 16 words of 8 characters and a maximum of 16 lists of alternative frequencies. These limits are not binding but have been advised by a sample of users.

4.8.3.
RDS board

The set of messages can be put on-air automatically at any hour of the day. Programming of the messages is very quick and easy; an entire message can be programmed in one minute. No special knowledge is necessary on the part of the user.

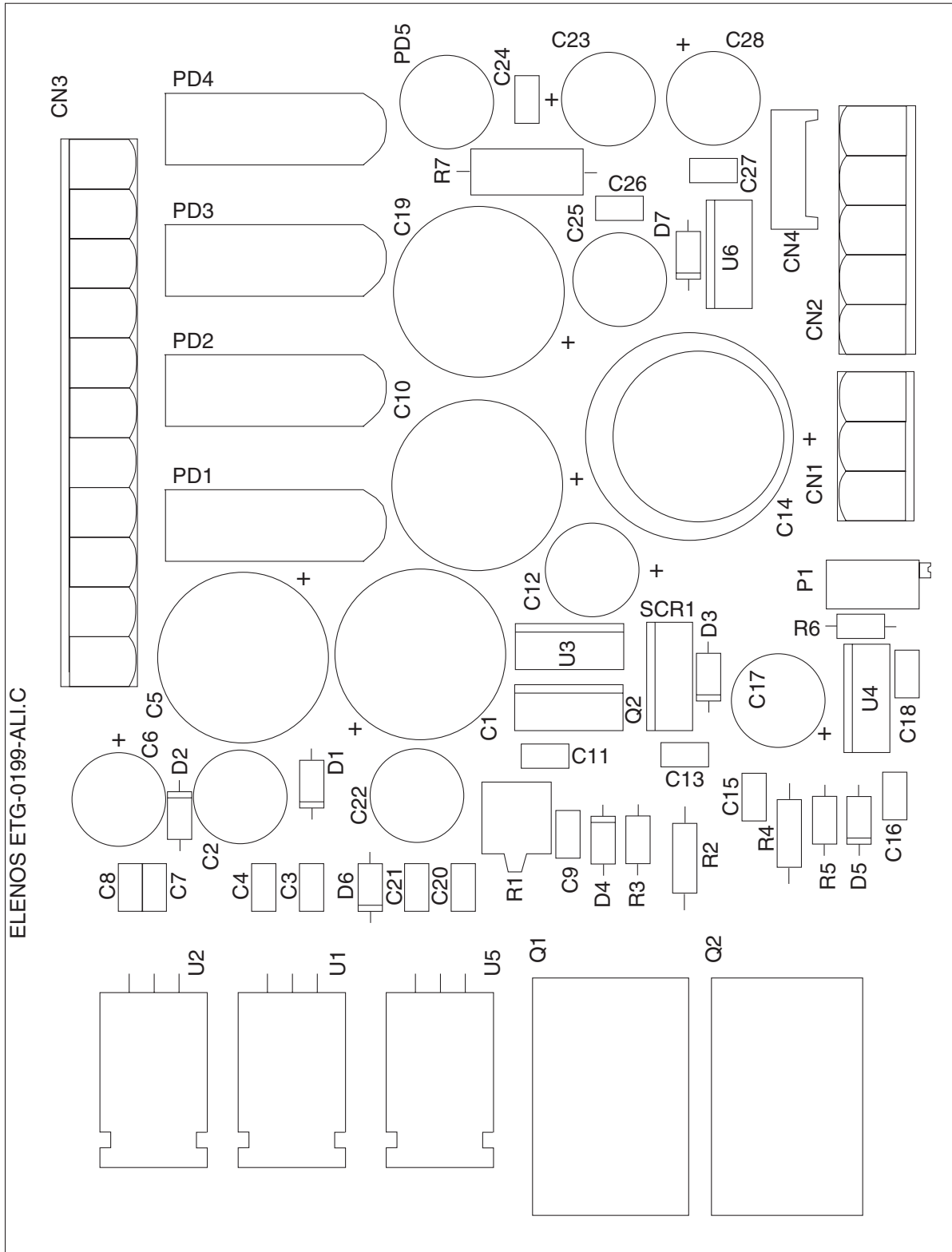

ELENOS ETG-0199-ALI.C

		
Via G.Amendola 9 44028 Poggio Renatico (FE) Italy Tel +39 0532 829965 Fax +39 0532 829177 Website WWW.ELENOS.COM		
Title: AUX POWER SUPPLY		
Board Code: ETG-0199-ALI.C	Model: ETG101-151	Rev 1
Proj. Engr. : A.Tomassini	Approved : A.Giovannelli	
Date: Wednesday, November 15, 2000	Sheet 1 of 1	

Pag 3 file A3

Parts list

Ref.	Description
CN1	WIELAND 3 M V
CN2	WIELAND 5 M V
CN3	HEADER 11
CN4	AMP MODUII 4 M V
C1	CEV 4700uF 35V
C5	CEV 4700uF 35V
C10	CEV 4700uF 35V
C19	CEV 4700uF 35V
C2	100nF 50V CER.
C2	CEV 100uF 63V
C6	CEV 100uF 63V
C12	CEV 100uF 63V
C17	CEV 100uF 63V
C22	CEV 100uF 63V
C3	CMY 0.1uF 63V
C4	CMY 0.1uF 63V
C7	CMY 0.1uF 63V
C8	CMY 0.1uF 63V
C9	CMY 0.1uF 63V
C11	CMY 0.1uF 63V
C13	CMY 0.1uF 63V
C15	CMY 0.1uF 63V
C16	CMY 0.1uF 63V
C18	CMY 0.1uF 63V
C20	CMY 0.1uF 63V
C21	CMY 0.1uF 63V
C14	CEV 2200uF 63V
D1	DIODE 1N4007
D2	DIODE 1N4007
D4	DIODE 1N4007
D5	DIODE 1N4007
D6	DIODE 1N4007
D3	BZX85C5V6
HOL1	CONNECTOR SCREW
HOL2	CONNECTOR SCREW
HOL3	CONNECTOR SCREW
HOL4	CONNECTOR SCREW
PD1	BRIDGE KBU8K
PD2	BRIDGE KBU8K
PD3	BRIDGE KBU8K
PD4	BRIDGE KBU8K
P1	RES. 67X 10K
Q1	BC337
Q1	TIP34C
Q3	TIP34C
Q2	BD140
R1	RES. 0.22R 5W 5%
R1	22K 0.25W 5%
R4	RES. 18R 0.5W 5%
R2	RES. 18R 0.5W 5%
R3	RES. 22R 0.25W 5%
R5	RES. 1K 0.25W 5%
R6	RES. 12K 0.25W 5%
SCR1	TIC216M
U1	LM7812CT

Parts list

Ref.	Description
U2	LM7912CT
U3	LM7805CT
U4	LM317
U5	UA7812

Serigrafia monoscheda *Pag 5 file A3*

Pag 6 file A3
Schema VCO

Pag 7 file A3
schema PLL

Pag 8 file A3
Schema MPX

Pag 9 file A3
Schema AGC

Pag 10 file A3
Schema CPU

Parts list

Ref.	Description
CN1	HEADER 10 Connett. per flat cable 2X5
CN2	AMP MODU II Connett. AMP MODU 2pin p 2,54
CX1	47uF Cond. elettrolitico Case D
C25	47uF Cond. elettrolitico Case D
C30	47uF Cond. elettrolitico Case D
C33	47uF Cond. elettrolitico Case D
CX10	22uF 25V (montato volante)
C1	1nF Cond. ceramico SMT 0805
C10	1nF Cond. ceramico SMT 0805
C11	1nF Cond. ceramico SMT 0805
C14	1nF Cond. ceramico SMT 0805
C18	1nF Cond. ceramico SMT 0805
C21	1nF Cond. ceramico SMT 0805
C22	1nF Cond. ceramico SMT 0805
C41	1nF Cond. ceramico SMT 0805
C139	1nF Cond. ceramico SMT 0805
C147	1nF Cond. ceramico SMT 0805
C149	1nF Cond. ceramico SMT 0805
C2	47uF Cond. tantalio Case 3528
C3	4.7nF Cond. ceramico SMT 0805
C5	4.7nF Cond. ceramico SMT 0805
C6	4.7nF Cond. ceramico SMT 0805
C9	4.7nF Cond. ceramico SMT 0805
C12	4.7nF Cond. ceramico SMT 0805
C13	4.7nF Cond. ceramico SMT 0805
C19	4.7nF Cond. ceramico SMT 0805
C23	4.7nF Cond. ceramico SMT 0805
C24	4.7nF Cond. ceramico SMT 0805
C26	4.7nF Cond. ceramico SMT 0805
C27	4.7nF Cond. ceramico SMT 0805
C28	4.7nF Cond. ceramico SMT 0805
C29	4.7nF Cond. ceramico SMT 0805
C31	4.7nF Cond. ceramico SMT 0805
C32	4.7nF Cond. ceramico SMT 0805
C34	4.7nF Cond. ceramico SMT 0805
C35	4.7nF Cond. ceramico SMT 0805
C40	4.7nF Cond. ceramico SMT 0805
C157	4.7nF Cond. ceramico SMT 0805
C158	4.7nF Cond. ceramico SMT 0805
C152	220nF Cond. ceramico SMT 0805
C4	220nF Cond. ceramico SMT 0805
C7	100nF Cond. ceramico SMT 0805
C15	100nF Cond. ceramico SMT 0805
C17	100nF Cond. ceramico SMT 0805
C20	100nF Cond. ceramico SMT 0805
C42	100nF Cond. ceramico SMT 0805
C43	100nF Cond. ceramico SMT 0805
C44	100nF Cond. ceramico SMT 0805
C45	100nF Cond. ceramico SMT 0805
C47	100nF Cond. ceramico SMT 0805
C49	100nF Cond. ceramico SMT 0805
C50	100nF Cond. ceramico SMT 0805
C51	100nF Cond. ceramico SMT 0805
C52	100nF Cond. ceramico SMT 0805
C54	100nF Cond. ceramico SMT 0805

Parts list

Ref.	Description
C56	100nF Cond. ceramico SMT 0805
C59	100nF Cond. ceramico SMT 0805
C60	100nF Cond. ceramico SMT 0805
C61	100nF Cond. ceramico SMT 0805
C62	100nF Cond. ceramico SMT 0805
C64	100nF Cond. ceramico SMT 0805
C68	100nF Cond. ceramico SMT 0805
C69	100nF Cond. ceramico SMT 0805
C73	100nF Cond. ceramico SMT 0805
C74	100nF Cond. ceramico SMT 0805
C75	100nF Cond. ceramico SMT 0805
C76	100nF Cond. ceramico SMT 0805
C77	100nF Cond. ceramico SMT 0805
C78	100nF Cond. ceramico SMT 0805
C79	100nF Cond. ceramico SMT 0805
C80	100nF Cond. ceramico SMT 0805
C83	100nF Cond. ceramico SMT 0805
C84	100nF Cond. ceramico SMT 0805
C85	100nF Cond. ceramico SMT 0805
C91	100nF Cond. ceramico SMT 0805
C92	100nF Cond. ceramico SMT 0805
C95	100nF Cond. ceramico SMT 0805
C96	100nF Cond. ceramico SMT 0805
C97	100nF Cond. ceramico SMT 0805
C98	100nF Cond. ceramico SMT 0805
C99	100nF Cond. ceramico SMT 0805
C104	100nF Cond. ceramico SMT 0805
C105	100nF Cond. ceramico SMT 0805
C106	100nF Cond. ceramico SMT 0805
C108	100nF Cond. ceramico SMT 0805
C109	100nF Cond. ceramico SMT 0805
C113	100nF Cond. ceramico SMT 0805
C116	100nF Cond. ceramico SMT 0805
C121	100nF Cond. ceramico SMT 0805
C122	100nF Cond. ceramico SMT 0805
C124	100nF Cond. ceramico SMT 0805
C125	100nF Cond. ceramico SMT 0805
C127	100nF Cond. ceramico SMT 0805
C128	100nF Cond. ceramico SMT 0805
C135	100nF Cond. ceramico SMT 0805
C138	100nF Cond. ceramico SMT 0805
C140	100nF Cond. ceramico SMT 0805
C151	100nF Cond. ceramico SMT 0805
C153	100nF Cond. ceramico SMT 0805
C155	100nF Cond. ceramico SMT 0805
C185	100nF Cond. ceramico SMT 0805
C8	1uF Cond. poliestere SMT (NON MONTARE)
C16	22nF Cond. ceramico SMT 0805
C36	10uF Cond. elettrolitico SMT Case C
C38	10uF Cond. elettrolitico SMT Case C
C144	10uF Cond. elettrolitico SMT Case C
C150	10uF Cond. elettrolitico SMT Case C
C39	10uF Cond. elettrolitico Case C
C37	10uF Cond. elettrolitico Case C
C46	4n7 Cond. ceramico SMT 0805

Parts list

Ref.	Description
C48	4n7 Cond. ceramico SMT 0805
C58	4n7 Cond. ceramico SMT 0805
C63	4n7 Cond. ceramico SMT 0805
C67	4n7 Cond. ceramico SMT 0805
C72	4n7 Cond. ceramico SMT 0805
C53	22pF Cond. ceramico SMT 0805
C57	22pF Cond. ceramico SMT 0805
C55	10uF Cond elettrolitico SMT Case C
C86	10uF Cond elettrolitico SMT Case C
C87	10uF Cond elettrolitico SMT Case C
C88	10uF Cond elettrolitico SMT Case C
C89	10uF Cond elettrolitico SMT Case C
C65	68pF Cond. ceramico SMT 0805
C66	68pF Cond. ceramico SMT 0805
C70	68pF Cond. ceramico SMT 0805
C71	68pF Cond. ceramico SMT 0805
C81	470nF Cond elettrolitico SMT Case B
C82	10uF/25V Cond elettrolitico SMT Case C
C90	10uF/25V Cond elettrolitico SMT Case C
C93	4.7uF Cond. elettrolitico SMT Case B
C94	100pF Cond. ceramico SMT 0805
C100	100pF Cond. ceramico SMT 0805
C107	100pF Cond. ceramico SMT 0805
C101	10pF Cond. ceramico SMT 0805
C102	10pF Cond. ceramico SMT 0805
C114	10pF Cond. ceramico SMT 0805
C112	2.2nF Cond. poliestere SMT
C103	2.2nF Cond. poliestere SMT
C110	10nF Cond. poliestere SMT
C111	47uF Cond. tantalio SMT Case 3528
C115	220nF Cond. poliestere SMT
C119	4,7uF Cond. tantalio SMT Case 3528
C126	4,7uF Cond. tantalio SMT Case 3528
C120	10uF Cond. tantalio SMT Case 3528
C123	10uF NP Cond. elettrolitico SMT Case C
C129	100uF Cond. tantalio SMT Case 7343
C130	100uF Cond. tantalio SMT Case 7343
C132	100uF Cond. tantalio SMT Case 7343
C133	100uF Cond. tantalio SMT Case 7343
C134	100uF Cond. tantalio SMT Case 7343
C131	47uF Cond. tantalio SMT Case 7343
C136	22uF Cond. elettrolitico SMT Case C
C137	10nF Cond. ceramico SMT 0805
C141	1500uF Cond elettolitico Vert. 6,3V
C142	68uF Cond. tantalio SMT Case 7343
C143	47nF Cond. ceramico SMT 0805 (NON MONTARE)
C145	220pF Cond. ceramico SMT 0805
C146	100nF Cond. ceramico SMT 0805 (NON MONTARE)
C148	470uF Cond. elettrolitico passo 5,08
C154	27pF Cond. ceramico SMT 0805
C156	47uF Cond. elettrolitico SMT Case D
C159	4.7pF Cond. ceramico SMT 0805
C160	33uF Cond. elettrolitico SMT Case C
C161	4.7nF Cond. ceramico SMT ATC 0805 X7R472KL2AT
C162	4.7nF Cond. ceramico SMT ATC 0805 X7R472KL2AT

Parts list

Ref.	Description	
C163	4.7nF	Cond. ceramico SMT ATC 0805 X7R472KL2AT
C164	4.7nF	Cond. ceramico SMT ATC 0805 X7R472KL2AT
C165	4.7nF	Cond. ceramico SMT ATC 0805 X7R472KL2AT
C167	4.7nF	Cond. ceramico SMT ATC 0805 X7R472KL2AT
C168	4.7nF	Cond. ceramico SMT ATC 0805 X7R472KL2AT
C173	4.7nF	Cond. ceramico SMT ATC 0805 X7R472KL2AT
C175	4.7nF	Cond. ceramico SMT ATC 0805 X7R472KL2AT
C176	4.7nF	Cond. ceramico SMT ATC 0805 X7R472KL2AT
C183	4.7nF	Cond. ceramico SMT ATC 0805 X7R472KL2AT
C184	4.7nF	Cond. ceramico SMT ATC 0805 X7R472KL2AT
C166	4.7uF	Cond. tantalio SMT Case 3528 16V
C169	1uF	Cond. tantalio SMT Case 3528 16V (non montare)
C182	33uF	Cond. elettrolitico SMT Case D 25V
C170	33uF	Cond. elettrolitico SMT Case D 25V
C171	1nF	Cond. ceramico tipo tradizionale
C172	1nF	Cond. ceramico SMT ATC 0805 X7R472KL2AT
C174	1nF	Cond. ceramico SMT ATC 0805 X7R472KL2AT
C180	1nF	Cond. ceramico SMT ATC 0805 X7R472KL2AT
C181	1nF	Cond. ceramico SMT ATC 0805 X7R472KL2AT
C177	470pF	Cond. ceramico SMT ATC 0805 X7R472KL2AT
C178	15pF	Cond. ceramico SMT ATC 0805 X7R472KL2AT
C179	220pF	Cond. ceramico SMT ATC 0805 X7R472KL2AT
DL1	LED	Led 3mm
DX10	1N82A	Diodo SMT MiniMelf (montato volante)
D5	4.7V	Diodo SMT MiniMelf
DZ1	4.7V	Diodo SMT MiniMelf
DZ20	10V 1/4W	Diodo Zener (montato volante)
D1	LM336-2.5V	Riferim. di tensione SMT SOIC8
D2	1N4148	Diodo SMT MiniMelf
D3	1N4148	Diodo SMT MiniMelf
D4	1N4148	Diodo SMT MiniMelf
D6	1N4148	Diodo SMT MiniMelf
D7	1N4148	Diodo SMT MiniMelf
D8	1N4148	Diodo SMT MiniMelf
D9	LM336/SO	Riferim. di tensione SMT SOIC8
D10	1N4148	Diodo SMT Case MiniMelf
D11	1N4148	Diodo SMT Case MiniMelf
D12	1N4148	Diodo SMT Case MiniMelf
D13	1N4148	Diodo SMT Case MiniMelf
D14	1N4148	Diodo SMT Case MiniMelf
D15	1N4148	Diodo SMT Case MiniMelf
D16	1N4148	Diodo SMT Case MiniMelf
D17	1N4148	Diodo SMT Case MiniMelf
D23	1N4148	Diodo SMT Case MiniMelf
D24	1N4148	Diodo SMT Case MiniMelf
D25	1N4148	Diodo SMT Case MiniMelf
D26	1N4148	Diodo SMT Case MiniMelf
D27	1N4148	Diodo SMT Case MiniMelf
D29	1N4148	Diodo SMT Case MiniMelf
D18	1N4002	Diodo SMT Case Melf
D19	1N4002	Diodo SMT Case Melf
D20	1N4148	Diodo SMT Case MiniMelf (montato volante)
D22	1N4148	Diodo SMT Case MiniMelf (NON MONTARE)
D21	1N4148	Diodo SMT Case MiniMelf (NON MONTARE)
D30	BAT42	Diodo Schottky assiale passo 10mm

Parts list

Ref.	Description	
D28	BAT42	Diodo Schottky assiale passo 10mm
D31	3V	Diodo Zener MiniMelf (NON MONTARE)
D32	US1A o 1N4148	Diodo SMD Case DO214
D33	BB515	Diodo Varicap SMT SOD323
D34	BB515	Diodo Varicap SMT SOD323
D35	BB515	Diodo Varicap SMT SOD323
D36	BB515	Diodo Varicap SMT SOD323
D37	BB515	Diodo Varicap SMT SOD323
D38	BB515	Diodo Varicap SMT SOD323
D39	BB515	Diodo Varicap SMT SOD323
D40	BB515	Diodo Varicap SMT SOD323
D41	BB515	Diodo Varicap SMT SOD323
D42	BB515	Diodo Varicap SMT SOD323
D43	BB515	Diodo Varicap SMT SOD323
D44	BB515	Diodo Varicap SMT SOD323
ISO1	NEC 2501	Fotoaccoppiatore NEC Dip8
JB1	CON26	Connettore DIN 41651 femm. vert. 2X13 pin
JB2	CON16	Connett. DIN 41651 femm. vert. 2X10 pin
JD1	CON26	Connettore per flat cable 2X13 pin (con ganci)
JP1	Jumper 3 poli	Jumper 3 pin con ponticello
JP4	Jumper 3 poli	Jumper 3 pin con ponticello
JP3	JUMPER	Jumper
JP2	JUMPER	Jumper
J1	CON8	Connettore passo 3,96mm
J2	DSUB9R	Connett. a vaschetta 9 poli femm. 90°
J3	BNC	BNC da pannello isolato
J4	BNC	BNC da pannello isolato
J5	BNC	BNC da pannello isolato
J6	SMB CS M VERT	Connett. SMB vert.
J8	SMB CS M VERT	Connett. SMB vert.
J9	DSUB25R	Connett. a vaschetta 25 poli femm. 90°
L1	2.2uH	Induttanza SMT 1212
L2	2.2uH	Induttanza SMT 1212
L3	2.2uH	Induttanza SMT 1212
L4	2.2uH	Induttanza SMT 1212
L5	2.2uH	Induttanza passo 10mm
L6	2.2uH	Induttanza passo 10mm
L7	2.2uH	Induttanza passo 10mm
L9	10uH-1A	Induttanza assiale passo 10mm
L8	10uH-1A	Induttanza assiale passo 10mm
L10	1mH	Induttanza assiale passo 10mm
L11	1mH	Induttanza assiale passo 10mm
L12	1mH	Induttanza assiale passo 10mm
L13	2.2uH	Induttanza assiale passo 10mm
L14	2.2uH	Induttanza assiale passo 10mm
L15	2.2uH	Induttanza assiale passo 10mm
L16	2.2uH	Induttanza assiale passo 10mm
L22	2.2uH	Induttanza assiale passo 10mm
L18	2.2uH	Induttanza assiale passo 7,5mm
L17	2.2uH	Induttanza assiale passo 7,5mm
L19	2.2uH	Induttanza assiale passo 7,5mm
L20	2.2uH	Induttanza assiale passo 7,5mm
L21	2.2uH	Induttanza assiale passo 7,5mm
QX1	BC817	Transistor SMT SOT23
Q1	BC817	Transistor SMT SOT23

Parts list

Ref.	Description
Q3	BC817 Transistor SMT SOT23
Q4	BC817 Transistor SMT SOT23
Q6	BC817 Transistor SMT SOT23
Q2	FMMT619 Transistor SMT SOT23
Q7	SMBT2222A Transistor SMT SOT23
Q5	SMBT2222A Transistor SMT SOT23
Q8	BC850 Transistor SMT SOT23
Q9	BF998 Fet SMT SOT143
Q10	BF998 Fet SMT SOT143
RR2	10K Rete resistiva 9+1
RR1	10K Rete resistiva 9+1
RR3	47K Rete resistiva 8 R singole SMT SOIC16
RR4	47K Rete resistiva 8 R singole SMT SOIC16
RW1	0 ohm Ponticello di corto circuito
RX1	4K7 Resistenza SMT 0805 5%
RX2	4K7 Resistenza SMT 0805 5%
RX3	4K7 Resistenza SMT 0805 5%
RX7	4K7 Resistenza SMT 0805 5%
R18	4K7 Resistenza SMT 0805 5%
R27	4K7 Resistenza SMT 0805 5%
R136	4K7 Resistenza SMT 0805 5%
R140	4K7 Resistenza SMT 0805 5%
R150	4K7 Resistenza SMT 0805 5%
R161	4K7 Resistenza SMT 0805 5%
R2	10K Resistenza SMT 0805 5%
RX4	10K Resistenza SMT 0805 5%
R4	10K Resistenza SMT 0805 5%
RX5	10K Resistenza SMT 0805 5%
RX8	10K Resistenza SMT 0805 5%
R13	10K Resistenza SMT 0805 5%
R15	10K Resistenza SMT 0805 5%
R20	10K Resistenza SMT 0805 5%
R21	10K Resistenza SMT 0805 5%
R24	10K Resistenza SMT 0805 5%
R25	10K Resistenza SMT 0805 5%
R28	10K Resistenza SMT 0805 5%
R37	10K Resistenza SMT 0805 5%
R39	10K Resistenza SMT 0805 5%
R40	10K Resistenza SMT 0805 5%
R43	10K Resistenza SMT 0805 5%
R44	10K Resistenza SMT 0805 5%
R46	10K Resistenza SMT 0805 5%
R47	10K Resistenza SMT 0805 5%
R49	10K Resistenza SMT 0805 5%
R50	10K Resistenza SMT 0805 5%
R51	10K Resistenza SMT 0805 5%
R52	10K Resistenza SMT 0805 5%
R53	10K Resistenza SMT 0805 5%
R54	10K Resistenza SMT 0805 5%
R56	10K Resistenza SMT 0805 5%
R57	10K Resistenza SMT 0805 5%
R59	10K Resistenza SMT 0805 5%
R61	10K Resistenza SMT 0805 5%
R63	10K Resistenza SMT 0805 5%
R67	10K Resistenza SMT 0805 5%

Parts list

Ref.	Description	
R68	10K	Resistenza SMT 0805 5%
R72	10K	Resistenza SMT 0805 5%
R84	10K	Resistenza SMT 0805 5%
R104	10K	Resistenza SMT 0805 5%
R105	10K	Resistenza SMT 0805 5%
R108	10K	Resistenza SMT 0805 5%
R110	10K	Resistenza SMT 0805 5%
R131	10K	Resistenza SMT 0805 5%
R137	10K	Resistenza SMT 0805 5%
R146	10K	Resistenza SMT 0805 5%
R162	10K	Resistenza SMT 0805 5%
R174	10K	Resistenza SMT 0805 5%
RX6	0	Resistenza SMT 0805 5%
RX10	10	Resistenza 5% (montato volante)
RX20	0 ohm	Ponticello di rame (montato volante)
R1	470	Resistenza SMT 0805 5%
R9	470	Resistenza SMT 0805 5%
R35	470	Resistenza SMT 0805 5%
R55	470	Resistenza SMT 0805 5%
R58	470	Resistenza SMT 0805 5%
R64	470	Resistenza SMT 0805 5%
R133	470	Resistenza SMT 0805 5%
R143	470	Resistenza SMT 0805 5%
R148	470	Resistenza SMT 0805 5%
R155	470	Resistenza SMT 0805 5%
R156	470	Resistenza SMT 0805 5%
R157	470	Resistenza SMT 0805 5%
R172	470	Resistenza SMT 0805 5%
R182	470	Resistenza SMT 0805 5%
R183	470	Resistenza SMT 0805 5%
R3	22	Resistenza SMT 0805 5%
R10	22	Resistenza SMT 0805 5%
R14	22	Resistenza SMT 0805 5%
R22	22	Resistenza SMT 0805 5%
R29	22	Resistenza SMT 0805 5%
R32	22	Resistenza SMT 0805 5%
R41	22	Resistenza SMT 0805 5%
R109	22	Resistenza SMT 0805 5%
R5	470K	Resistenza SMT 0805 5%
R17	470K	Resistenza SMT 0805 5%
R152	5K6	Resistenza SMT 0805 5%
R6	5K6	Resistenza SMT 0805 5%
R7	10	Resistenza SMT 0805 5%
R12	10	Resistenza SMT 0805 5%
R121	10	Resistenza SMT 0805 5%
R129	10	Resistenza SMT 0805 5%
R177	10	Resistenza SMT 0805 5%
R8	220K	Resistenza SMT 0805 5%
R11	220K	Resistenza SMT 0805 5%
R23	220K	Resistenza SMT 0805 5%
R16	8K2	Resistenza SMT 0805 5%
R19	1M	Resistenza SMT 0805 5%
R36	1M	Resistenza SMT 0805 5%
R124	1M	Resistenza SMT 0805 5%
R141	1M	Resistenza SMT 0805 5%

Parts list

Ref.	Description
R26	1K Resistenza SMT 0805 5%
R30	1K Resistenza SMT 0805 5%
R33	1K Resistenza SMT 0805 5%
R34	1K Resistenza SMT 0805 5%
R42	1K Resistenza SMT 0805 5%
R60	1K Resistenza SMT 0805 5%
R70	1K Resistenza SMT 0805 5%
R76	1K Resistenza SMT 0805 5%
R147	1K Resistenza SMT 0805 5%
R158	1K Resistenza SMT 0805 5%
R160	1K Resistenza SMT 0805 5%
R31	2K2 Resistenza SMT 0805 5%
R38	2K2 Resistenza SMT 0805 5%
R86	2K2 Resistenza SMT 0805 5%
R100	2K2 Resistenza SMT 0805 5%
R164	2K2 Resistenza SMT 0805 5%
R48	18K Resistenza SMT 0805 5%
R45	18K Resistenza SMT 0805 5%
R62	100 Resistenza SMT 0805 5%
R138	100 Resistenza SMT 0805 5%
R163	100 Resistenza SMT 0805 5%
R66	100K Resistenza SMT 0805 5%
R65	100K Resistenza SMT 0805 5%
R69	4K99 1% Resistenza SMT 0805 1%
R71	4K99 1% Resistenza SMT 0805 1%
R74	4K99 1% Resistenza SMT 0805 1%
R75	4K99 1% Resistenza SMT 0805 1%
R79	4K99 1% Resistenza SMT 0805 1%
R81	4K99 1% Resistenza SMT 0805 1%
R83	4K99 1% Resistenza SMT 0805 1%
R89	4K99 1% Resistenza SMT 0805 1%
R91	4K99 1% Resistenza SMT 0805 1%
R92	4K99 1% Resistenza SMT 0805 1%
R93	4K99 1% Resistenza SMT 0805 1%
R96	4K99 1% Resistenza SMT 0805 1%
R102	4K99 1% Resistenza SMT 0805 1%
R106	4K99 1% Resistenza SMT 0805 1%
R107	4K99 1% Resistenza SMT 0805 1%
R117	4K99 1% Resistenza SMT 0805 1%
R118	4K99 1% Resistenza SMT 0805 1%
R120	4K99 1% Resistenza SMT 0805 1%
R122	4K99 1% Resistenza SMT 0805 1%
R123	4K99 1% Resistenza SMT 0805 1%
R127	4K99 1% Resistenza SMT 0805 1%
R73	100 1% Resistenza SMT 0805 1%
R77	100 1% Resistenza SMT 0805 1%
R103	100 1% Resistenza SMT 0805 1%
R115	100 1% Resistenza SMT 0805 1%
R119	100 1% Resistenza SMT 0805 1%
R126	100 1% Resistenza SMT 0805 1%
R78	1K 1% Resistenza SMT 0805 1%
R80	1K 1% Resistenza SMT 0805 1%
R82	1K 1% Resistenza SMT 0805 1%
R95	1K 1% Resistenza SMT 0805 1%
R98	1K 1% Resistenza SMT 0805 1%

Parts list

Ref.	Description	
R99	1K 1%	Resistenza SMT 0805 1%
R112	1K 1%	Resistenza SMT 0805 1%
R85	47K	Resistenza SMT 0805 5%
R113	47K	Resistenza SMT 0805 5%
R149	47K	Resistenza SMT 0805 5%
R101	220	Resistenza SMT 0805 5%
R87	220	Resistenza SMT 0805 5%
R88	4K42 1%	Resistenza SMT 0805 1%
R90	47	Resistenza SMT 0805 5%
R97	47	Resistenza SMT 0805 5%
R128	47	Resistenza SMT 0805 5%
R94	100R	Resistenza SMT 0805 5%
R111	100R	Resistenza SMT 0805 5%
R116	100R	Resistenza SMT 0805 5%
R114	6M8	Resistenza SMT 0805 5%
R125	22K	Resistenza SMT 0805 5%
R130	2K7	Resistenza SMT 0805 5%
R135	2K7	Resistenza SMT 0805 5%
R151	2K7	Resistenza SMT 0805 5%
R180	120	Resistenza SMT 0805 5%
R132	120	Resistenza SMT 0805 5%
R134	27	Resistenza SMT 0805 5%
R139	56	Resistenza SMT 0805 5%
R170	56	Resistenza SMT 0805 5%
R176	56	Resistenza SMT 0805 5%
R179	56	Resistenza SMT 0805 5%
R184	56	Resistenza SMT 0805 5%
R142	27K	Resistenza SMT 0805 5%
R165	27K	Resistenza SMT 0805 5%
R144	390	Resistenza SMT 0805 5%
R145	1K5	Resistenza SMT 0805 5%
R153	6K	Resistenza SMT 0805 5%
R154	12K	Resistenza SMT 0805 5%
R166	12K	Resistenza SMT 0805 5%
R167	12K	Resistenza SMT 0805 5%
R159	15K	Resistenza SMT 0805 5%
R178	270	Resistenza assiale 1/4W 10%
R168	270	Resistenza assiale 1/4W 10%
R169	620	Resistenza SMT 0805 5%
R171	820	Resistenza SMT 0805 5%
R173	330K	Resistenza SMT 0805 5%
R175	15	Resistenza SMT 0805 5%
R181	20K	Resistenza SMT 0805 5%
SC1	SCREW	Vite fissaggio N3X5mm
SC2	SCREW	Vite fissaggio N3X5mm
SC3	SCREW	Vite fissaggio N3X5mm
SC4	SCREW	Vite fissaggio N3X5mm
SC5	SCREW	Vite fissaggio N3X5mm
SC6	SCREW	Vite fissaggio N3X5mm
SC7	SCREW	Vite fissaggio N3X5mm
SH1	VCO SHELD	Scatolino VCO e PLL
SH2	PLL SHELD	Scatolino VCO e PLL
TL1	75 ohm	Cavo coassiale Belden
TP1	INP	Test point
TP2	OUT	Test point

Parts list

Ref.	Description
TP3	SCA Test point
TP4	LEV CC Test point
TP5	Vpll TEST POINT Test point
U2	LM324 IC SMT SOIC14
U1	LM324 IC SMT SOIC14
U3	LMC7101/SOT23 Op-Amp SMT SOT23-5
U8	LMC7101/SOT23 Op-Amp SMT SOT23-5
U14	LMC7101/SOT23 Op-Amp SMT SOT23-5
U21	LMC7101/SOT23 Op-Amp SMT SOT23-5
U4	PCF80C552 IC PLCC28 Con zoccolo
U5	74HC138 IC SMT SOIC16
U6	74HC00 IC SMT SOIC14
U10	74HC574 IC SMT SOIC20 Wide
U7	74HC574 IC SMT SOIC20 Wide
U9	7421 IC SMT SOIC14
U11	TL7705 IC SMT SOIC8
U12	74HC08
U13	74HC157AS IC SMT SOIC16
U15	74HC573 IC SMT SOIC20 Wide
U16	74HC245 IC SMT SOIC20 Wide
U20	74HC245 IC SMT SOIC20 Wide
U19	MAX485 IC SMT SOIC8
U17	MAX485 IC SMT SOIC8
U18	AT27C020/LCC IC PLCC32 Con zoccolo
U22	62256 IC SMT SOIC28 Wide
U23	ST24C02 IC SMT SOIC8
U24	MC74HC595 IC SMT SOIC16
U25	CS3310 IC SMT SOIC16
U27	MC33078 IC SMT SOIC8
U26	MC33078 IC SMT SOIC8
U28	SSM2404 IC SMT SOIC20 Wide
U29	LF347 IC SMT SOIC14
U31	LF347 IC SMT SOIC14
U30	LF353
U32	LM79L05AC IC SMT SOIC8
U34	LF353 IC SMT SOIC8
U35	LM358 IC SMT SOIC8
U39	LM358 IC SMT SOIC8
U36	10MHz TCXO SMT MEC
U37	H11F1 Fotoaccoppiatore Dip6
U38	LMX1501AM IC SMT SOIC16
U40	AD797 o NE5534 IC SMT SOIC8
U41	AD587 IC SMT SOIC8 (non montare)
U42	ERA 3 MMIC
U43	ERA 3 MMIC
U44	74HC4067 IC SMT SOIC24 Wide
VR1	100K Trimmer multigiri vert. oin in linea
VR2	1K Trimmer multig. vert. pin in linea
VR4	10K Trimmer multig. lungo orizz.
VR3	10K Trimmer multig. lungo orizz.
VR5	50K Trimmer multig. vert. pin in linea
VR6	10K Trimmer multig. vert pin in linea
Y1	16MHz Quarzo HC49

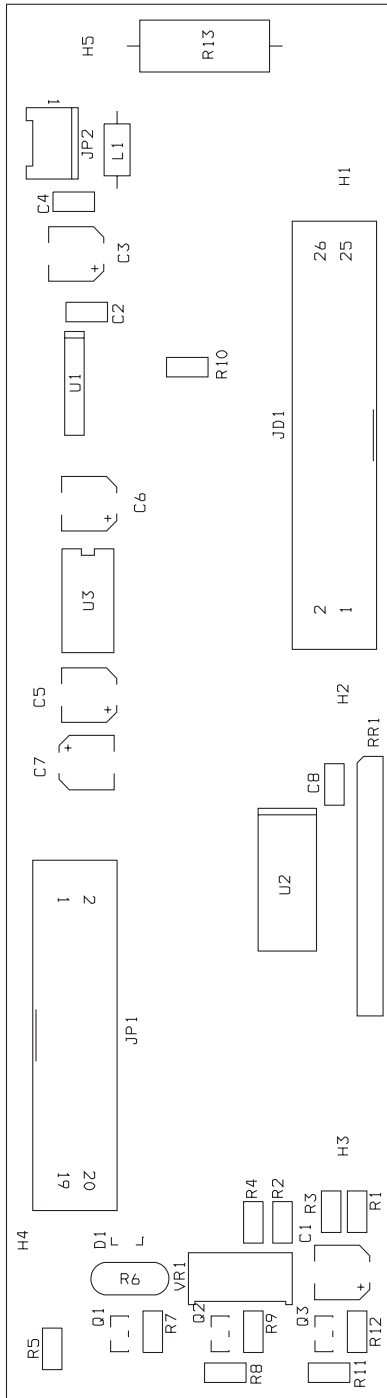

 Via G.Amendola 9 44028 Poggio Renatico (FE) Italy Tel +39 0532 829965 Fax +39 0532 829177 Website WWW.ELENOS.COM		
		Title: KEYBOARD
Board Code: KEYB.ETG500V1.0A	Model: ETG101-151	Rev 1
Proj. Engr. : A.Tomassini	Approved : A.Giovannelli	
Date: Wednesday, November 15, 2000	Sheet	1 of 1

Pag 11 file A3
Schema Keyboard

Parts list

Ref.	Description
C3	10uF/25V
C1	10uF/25V
C2	100nF
C4	100nF
C8	100nF
C5	10u
C6	10u
C7	10u
D1	BAT64
H1	CON1
H2	CON1
H3	CON1
H4	CON1
H5	CON1
JD1	CON26
JP1	DISPLAY
JP2	CONN 2
LD1	LED
LD2	LED
LD3	LED
L1	2,2uH
SW1	SWITCH
P1	SWITCH
P2	SWITCH
P3	SWITCH
P4	SWITCH
P5	SWITCH
P6	SWITCH
P7	SWITCH
P8	SWITCH
Q1	BC817
Q2	BC817
Q3	BC817
RR1	10K
R7	10K
R9	10K
R10	10K
R12	10K
R1	4K7
R2	N.M.
R3	2K2
R4	1K
VR1	1K
R5	330
R8	330
R11	330
R6	VARISTOR
R13	3,3 2W
U1	14042
U2	74HC245
U3	LTC1054CN8

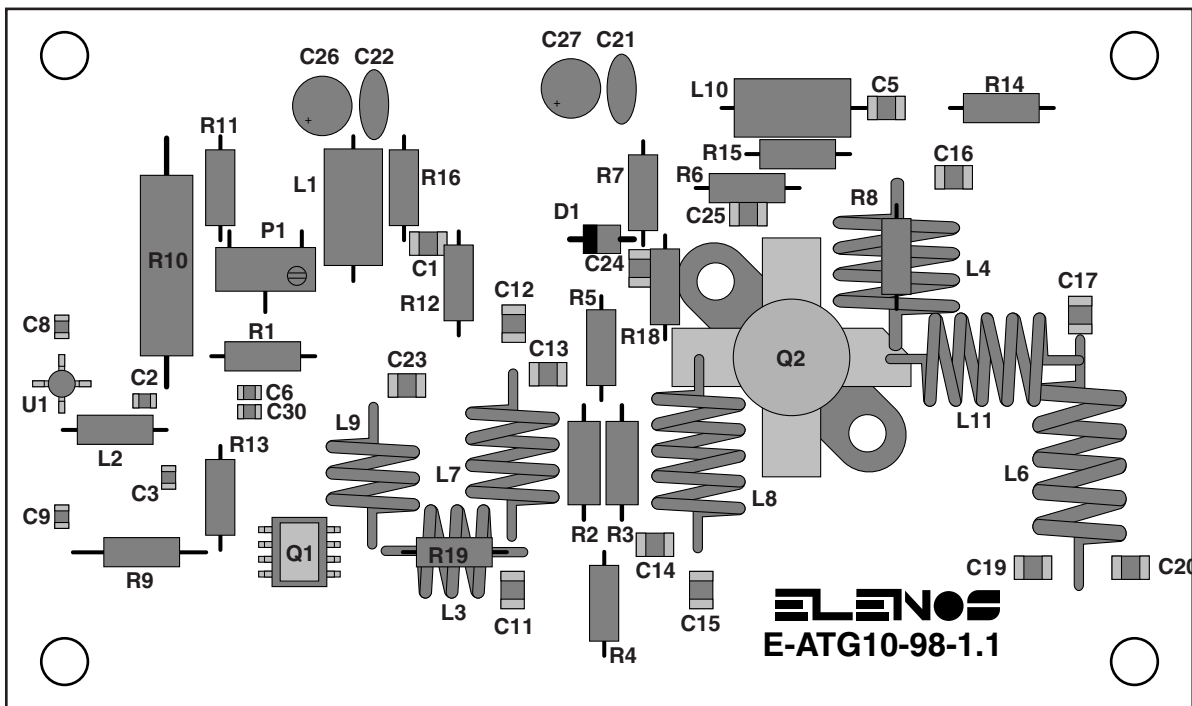

ELENOS		Via G.Amendola 9 44028 Poggio Renatico (FE) Italy Tel +39 0532 829965 Fax +39 0532 829177 Website WWW.ELENOS.COM	
Title: DRIVER			
Board Code:	E-ATG-98-1.1	Model:	ETG101-151
Proj. Engr. :	A.Tomassini	Approved :	A.Giovannelli
Date:	Wednesday, November 15, 2000	Sheet	1 of 1

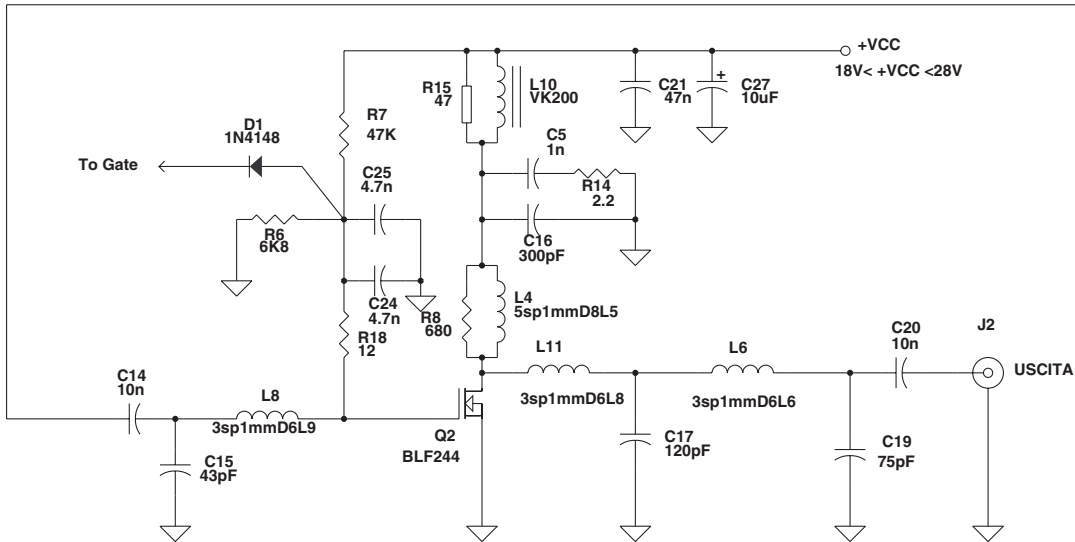
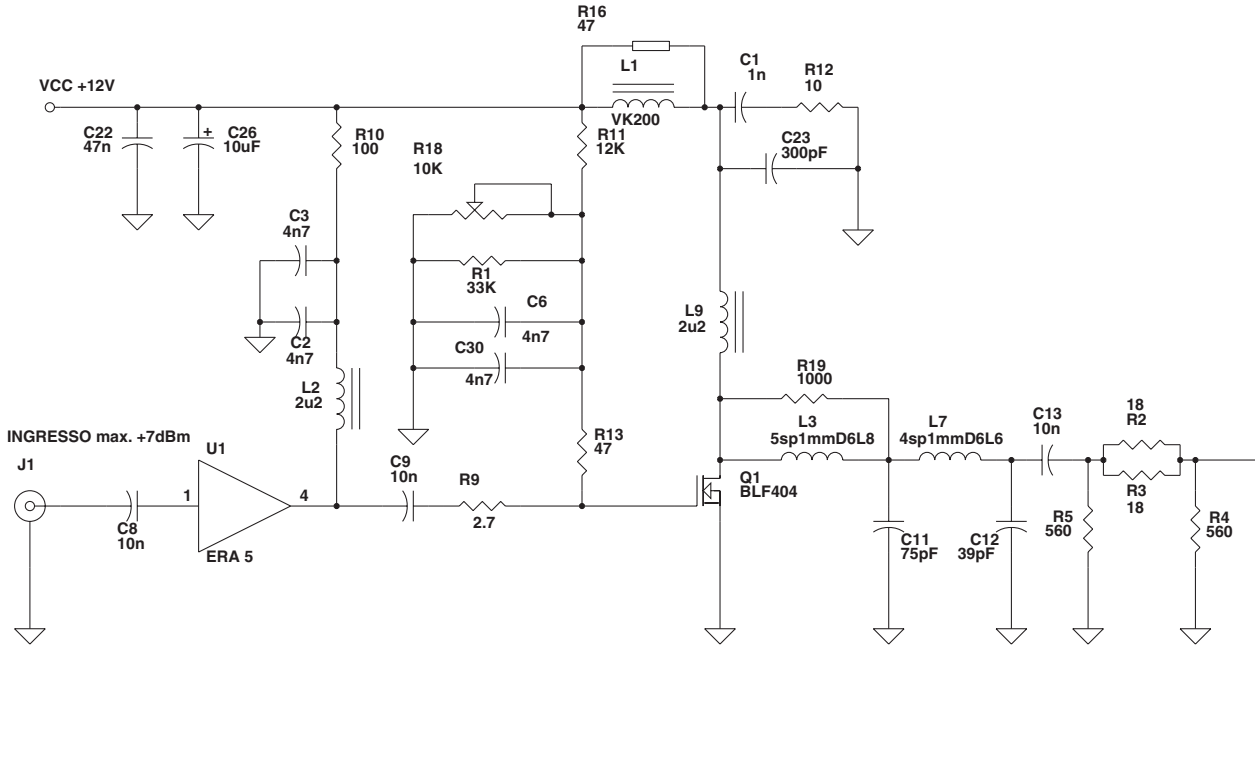

		Via G.Amendola 9 44028 Poggio Renatico (FE) Italy	
		Tel +39 0532 829965 Fax +39 0532 829177	
		Website WWW.ELENOS.COM	
Title: DRIVER			
Board Code: E-ATG10-98-1.1	Model: ETG101-151	Rev 1.1	
Proj. Engr. : A.Tomassini	Approved : A.Giovannelli		
Date: Wednesday, November 15, 2000	Sheet 1 of 1		

Parts list

Ref.	Description
C1	1n
C5	1n
C2	4n7
C3	4n7
C6	4n7
C30	4n7
C8	10n
C9	10n
C13	10n
C14	10n
C20	10n
C19	75pF
C11	75pF
C12	39pF
C15	43pF
C16	300pF
C23	300pF
C17	120pF
C22	47n
C21	47n
C24	4.7n
C25	4.7n
C27	10uF
C26	10uF
J1	INGRESSO max. +7dBm
J2	USCITA
L1	VK200
L10	VK200
L2	2u2
L9	2u2
L3	5sp1mmD6L8
L4	5sp1mmD8L5
L6	3sp1mmD6L6
L7	4sp1mmD6L6
L8	3sp1mmD6L9
L11	3sp1mmD6L8
Q1	BLF404
Q2	BLF244
R1	33K
R2	18
R3	18
R4	560
R5	560
R6	6K8
R7	47K
R8	680
R9	2.7
R10	100
R11	12K
R12	10
R13	47
R15	47
R16	47
R14	2.2
R18	10K

Parts list

Ref.	Description
R18	12
R19	1000
U1	ERA 5
D1	1N4148

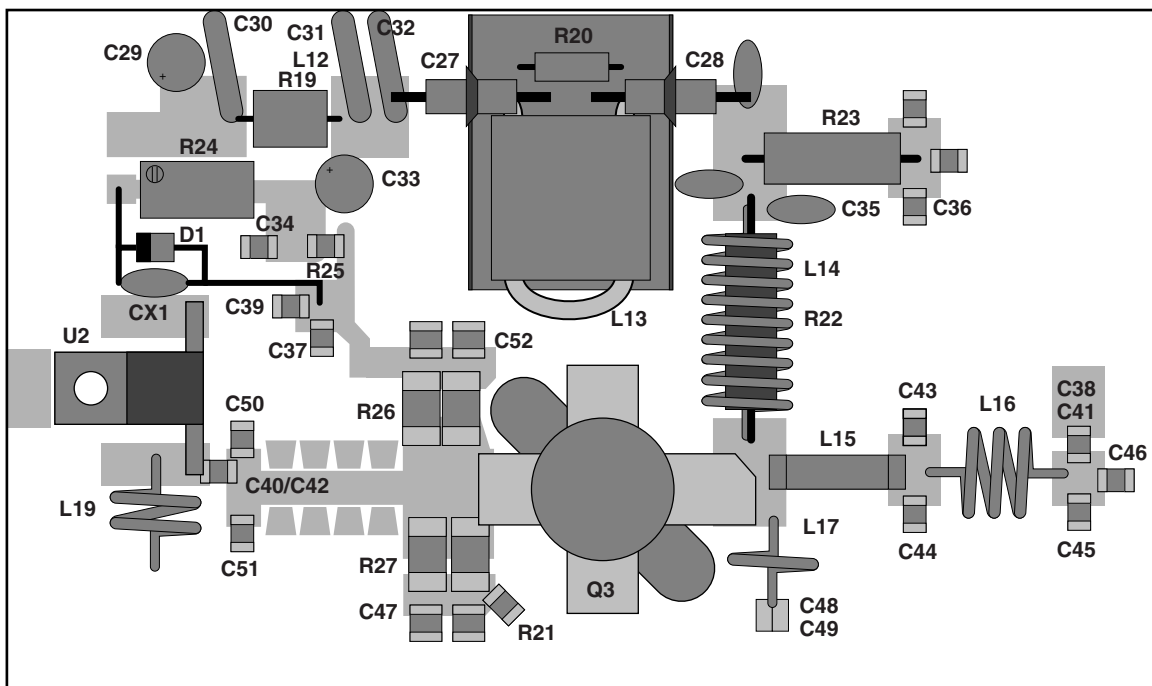

ELENOS		Via G.Amendola 9 44028 Poggio Renatico (FE) Italy Tel +39 0532 829965 Fax +39 0532 829177 Website WWW.ELENOS.COM	
Title: POWER AMPLIFIER			
Board Code:	E-ATG150-00-1.2	Model:	ETG101-151
Proj. Engr. :	A.Tomassini	Approved :	A.Giovannelli
Date:	Wednesday, November 15, 2000	Sheet	1 of 1

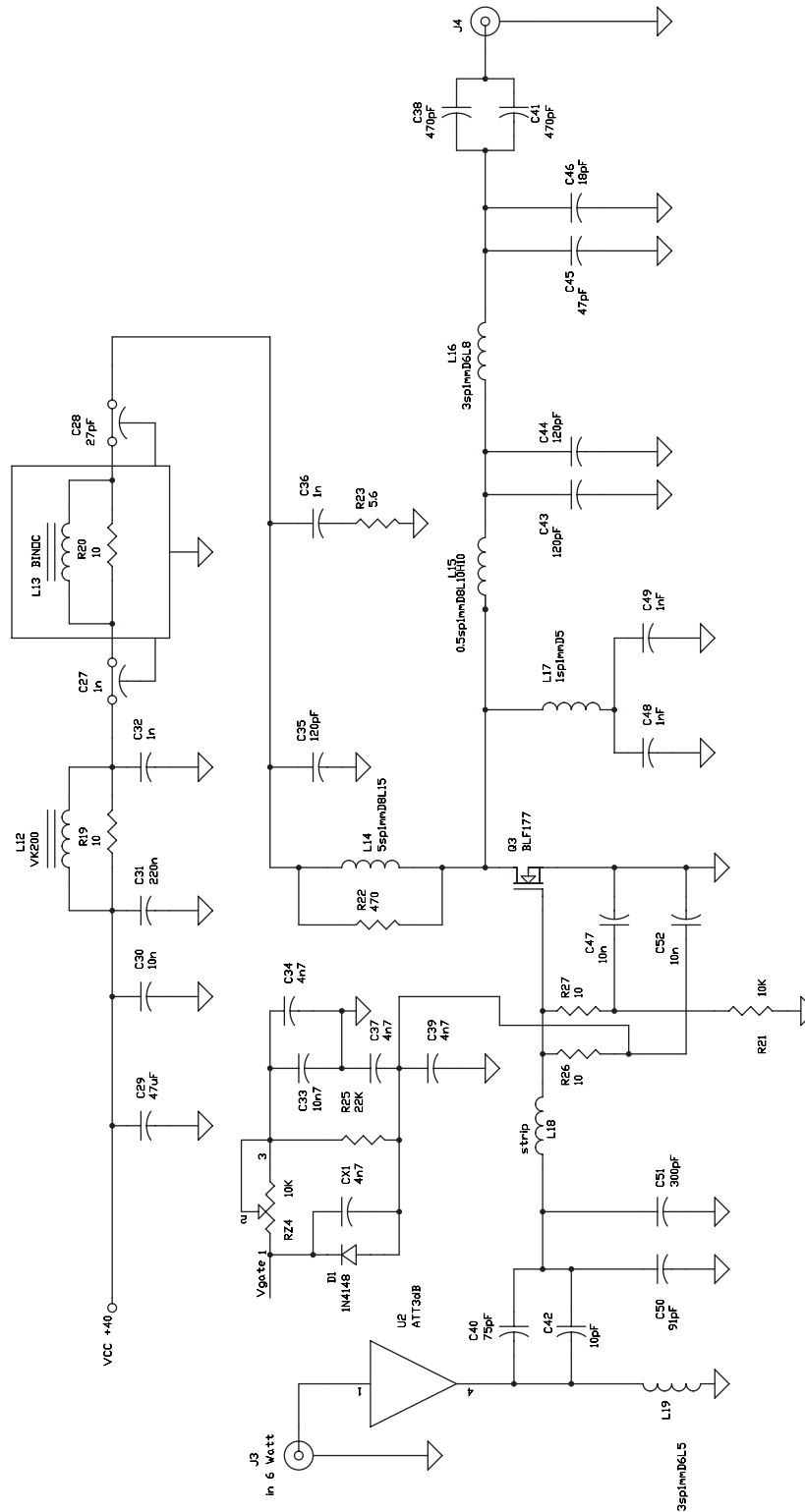

		Via G.Amendola 9 44028 Poggio Renatico (FE) Italy Tel +39 0532 829965 Fax +39 0532 829177 Website WWW.ELENOS.COM	
Title: POWER AMPLIFIER			
Board Code: E-ATG150-98-1.1	Model: ETG101-151	Rev 1.1	
Proj. Engr. : A.Tomassini	Approved : A.Giovannelli		
Date: Wednesday, November 15, 2000	Sheet	1	of 1

Parts list

Ref.	Description
CX1	4n7
C34	4n7
C37	4n7
C39	4n7
C27	1n
C32	1n
C36	1n
C28	27pF
C29	47uF
C30	10n
C47	10n
C52	10n
C31	220n
C33	10n7
C35	120pF
C43	120pF
C44	120pF
C38	470pF
C41	470pF
C40	75pF
C42	10pF
C45	47pF
C46	18pF
C48	1nF
C49	1nF
C50	91pF
C51	300pF
D1	1N4148
J3	in 6 Watt
J4	out 100 Watt
L12	VK200
L13	BINOC
L14	5sp1mmD8L15
L15	0.5sp1mmD8L10H10
L16	3sp1mmD6L8
L17	1sp1mmD5
L18	strip
L19	3sp1mmD6L5
Q3	BLF177
RZ4	10K
R21	10K
R19	10
R20	10
R26	10
R27	10
R22	470
R23	5.6
R25	22K

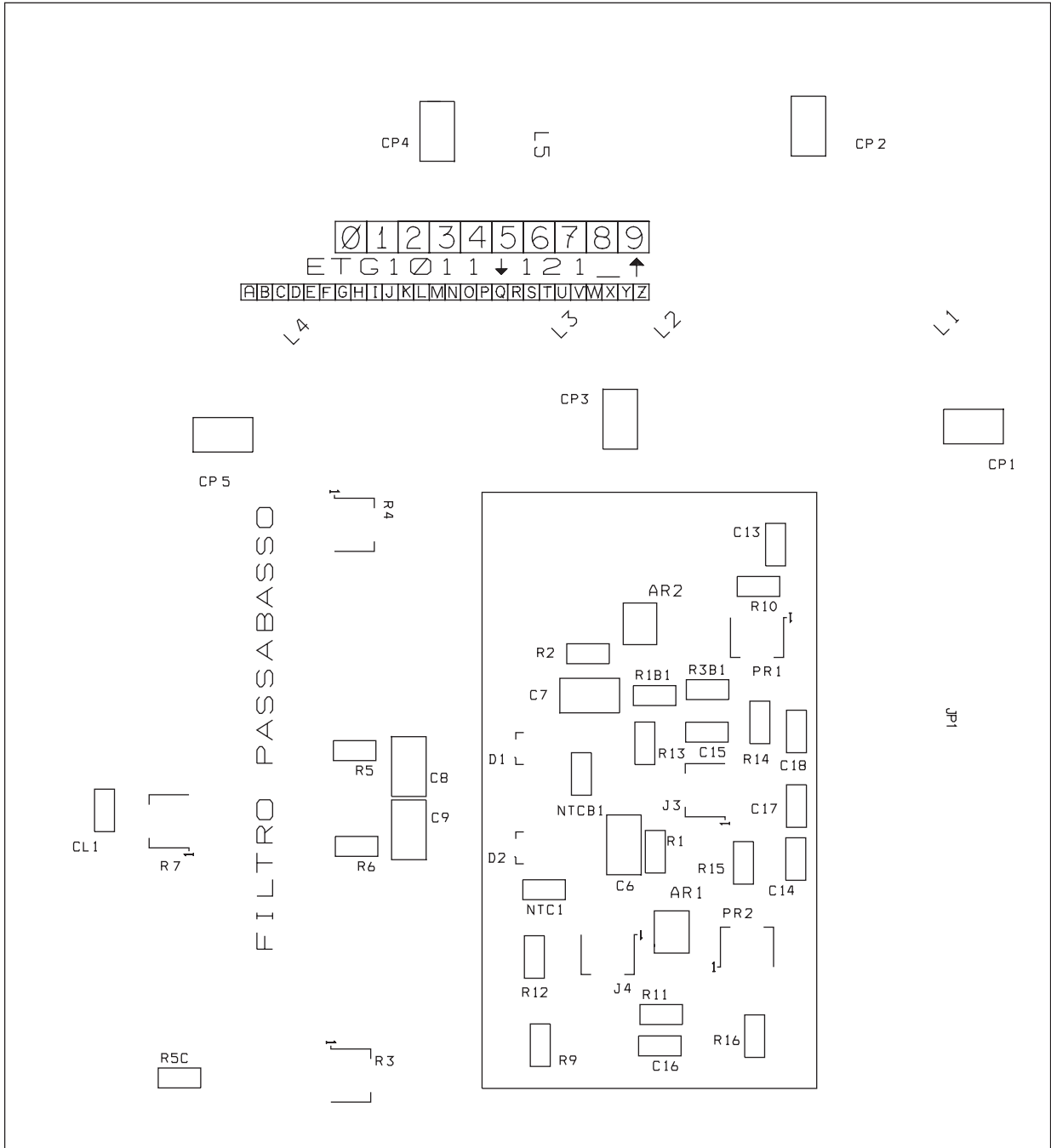

ELENOS		Via G.Amendola 9 44028 Poggio Renatico (FE) Italy Tel +39 0532 829965 Fax +39 0532 829177 Website WWW.ELENOS.COM	
Title: LPF AND POWER PROBE			
Board Code: ETG1011A121_0	Model: ETG101-151	Rev 1	
Proj. Engr. : A.Tomassini	Approved : A.Giovanelli		
Date: Wednesday, November 15, 2000	Sheet	1	of 1

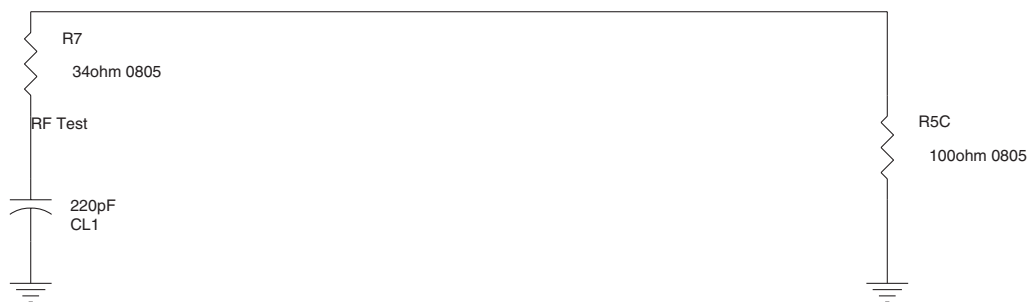
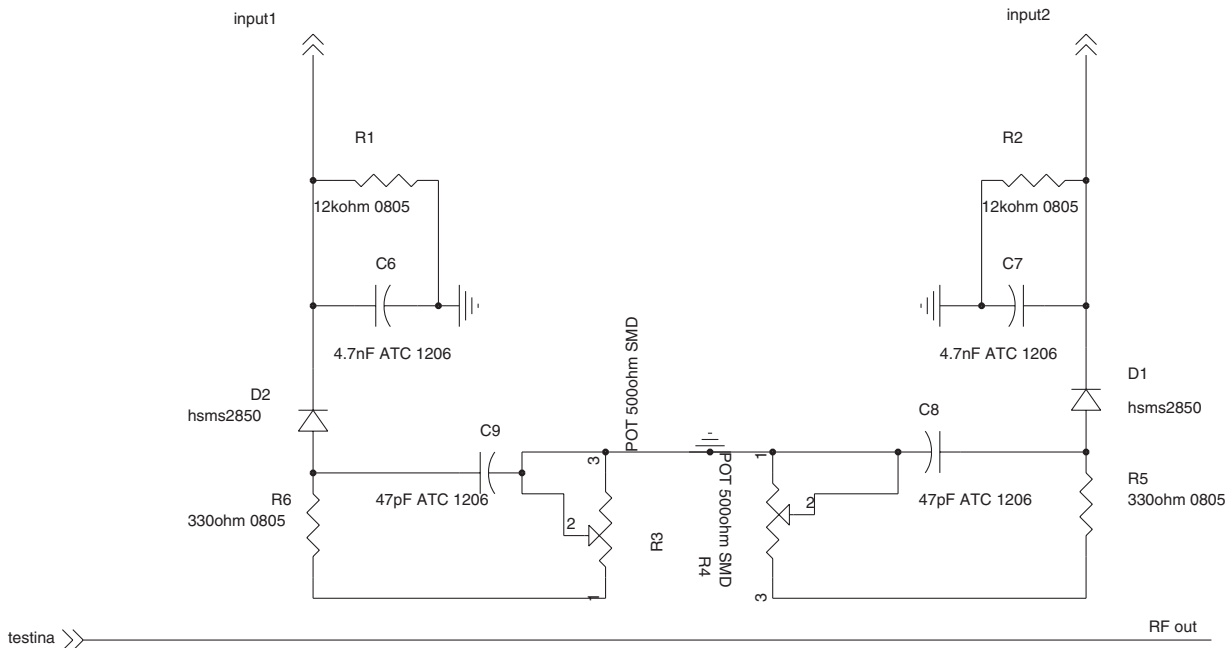

Via G.Amendola 9 44028 Poggio Renatico (FE) Italy Tel +39 0532 829965 Fax +39 0532 829177 Website WWW.ELENOS.COM		
Title: POWER PROBES		
Board Code: 2PCB0266B	Model: ETG101-151	Rev 1
Proj. Engr. : A.Tomassini	Approved : A.Gioannelli	
Date: Wednesday, November 15, 2000	Sheet 1	of 3

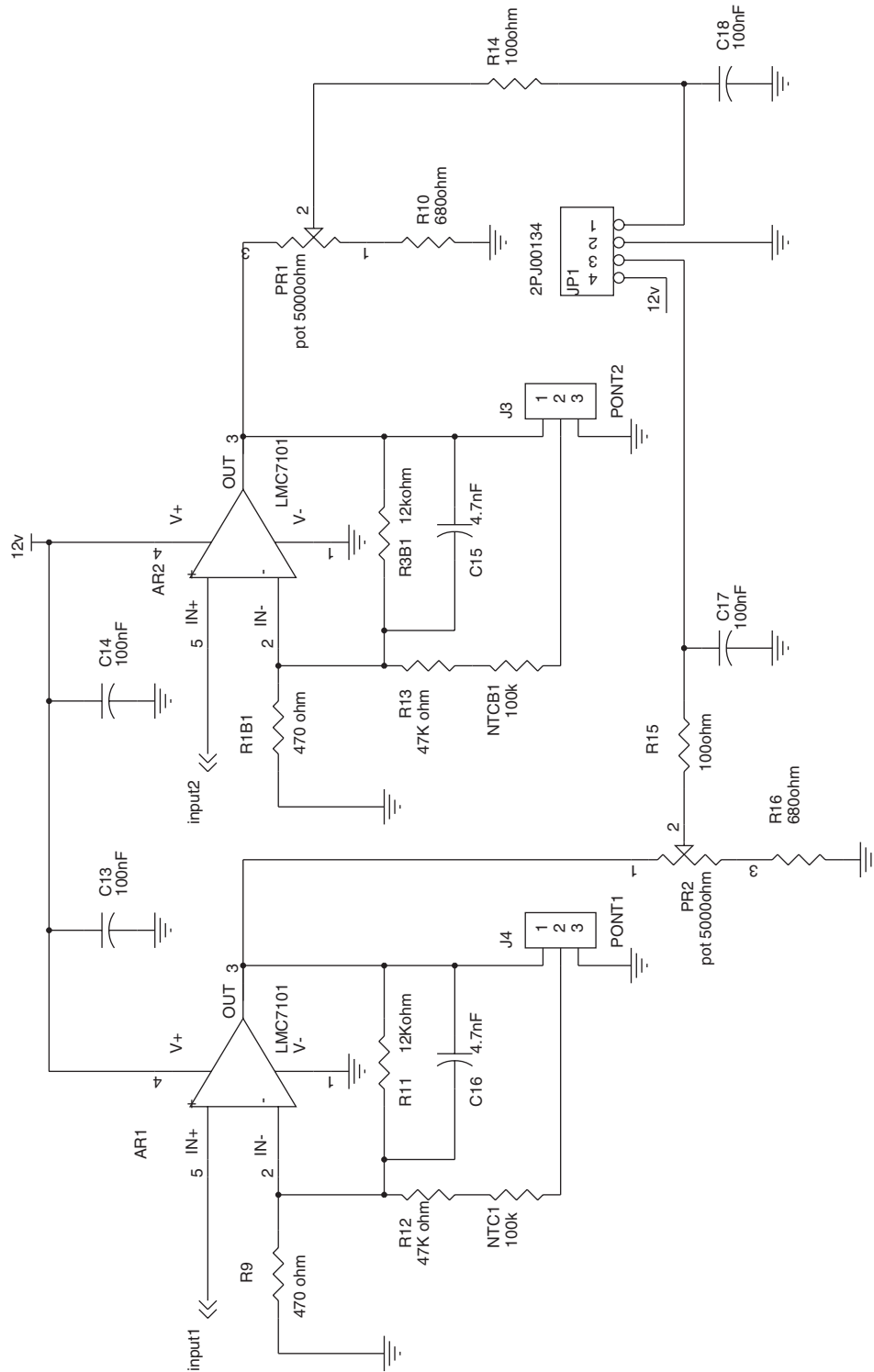

ELENOS		Via G. Amendola 9 44028 Poggio Renatico (FE) Italy Tel +39 0532 829965 Fax +39 0532 829177 Website WWW.ELENOS.COM	
Title: POWER PROBE AMPLIFIER			
Board Code:	2PCB0266B	Model:	ETG101-151
Proj. Engr. :	A.Tomassini	Approved :	A.Giovannelli
Date:	Wednesday, November 15, 2000	Sheet	2 of 3
			Rev 1

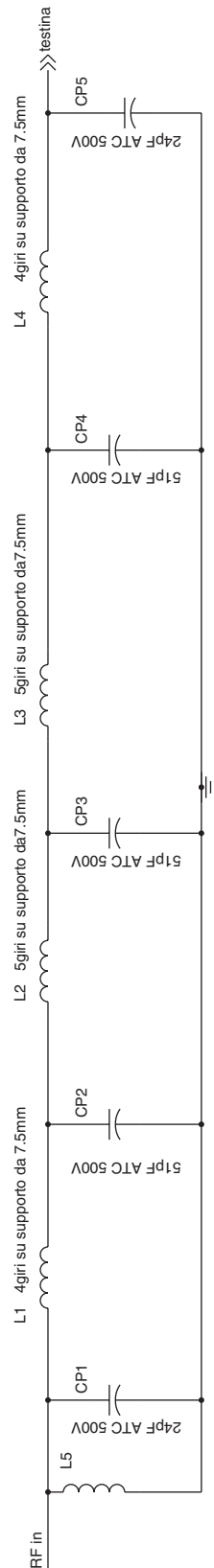

		Via G.Amendola 9 44028 Poggio Renatico (FE) Italy Tel +39 0532 829965 Fax +39 0532 829177 Website WWW.ELENOS.COM		
		Title: LPF		
Board Code:	2PCB0266B	Model:	ETG101-151	Rev 1
Proj. Engr. :	A.Tomassini	Approved :	A.Giovannelli	
Date:	Wednesday, November 15, 2000	Sheet	3 of 3	

Parts list

Ref.	Description
AR1	LMC7101
AR2	LMC7101
CP1	18pF ATC 500V
CP9	18pF ATC 500V
CP10	18pF ATC 500V
CP11	18pF ATC 500V
CP12	18pF ATC 500V
CP2	7.5pF ATC 500V
CP8	7.5pF ATC 500V
CP13	7.5pF ATC 500V
CP3	27pF ATC 500V
CP4	27pF ATC 500V
CP5	3pF ATC 500V
CP7	22pF ATC 500V
CP6	22pF ATC 500V
C7	4.7nF ATC 1206
C6	4.7nF ATC 1206
C8	47pF ATC 1206
C9	47pF ATC 1206
C13	100nF 0805
C14	100nF 0805
C17	100nf 0805
C18	100nF 0805
C15	4.7nF 0805
C16	4.7nF 0805
D2	hsms2850
D1	hsms2850
JP1	2PJ00134
J4	CON3
J3	CON3
L1	vedi note
L2	vedi note
L3	vedi note
L4	vedi note
L5	vedi note
NTC1	100k c620
NTCB1	100k c620
PR1	pot 5000ohm SMD
PR2	pot 5000ohm SMD
R3	POT 500ohm SMD
R4	POT 500ohm SMD
R1	12kohm 0805
R2	12kohm 0805
R11	12Kohm 0805
R6	330ohm 0805
R5	330ohm 0805
R5C	100ohm 0805
R14	100ohm 0805
R15	100ohm 0805
R7	34ohm 0805
R9	470 ohm 0805
R1B1	470 ohm 0805
R10	680ohm 0805
R16	680ohm 0805
R12	47Kohm 0805

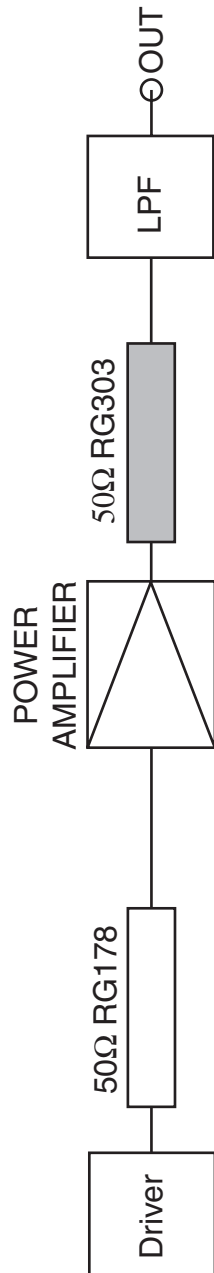

ELENOS		Via G.Amendola 9 44028 Poggio Renatico (FE) Italy Tel +39 0532 829965 Fax +39 0532 829177 Website WWW.ELENOS.COM	
Title: SPLITTER INPUT AND COMBINER OUTPUT			
Board Code:	Model: ETG101-151	Rev 1	
Proj. Engr. : A.Tomassini	Approved : A.Gioannelli		
Date: Wednesday, November 15, 2000	Sheet	1	of 1

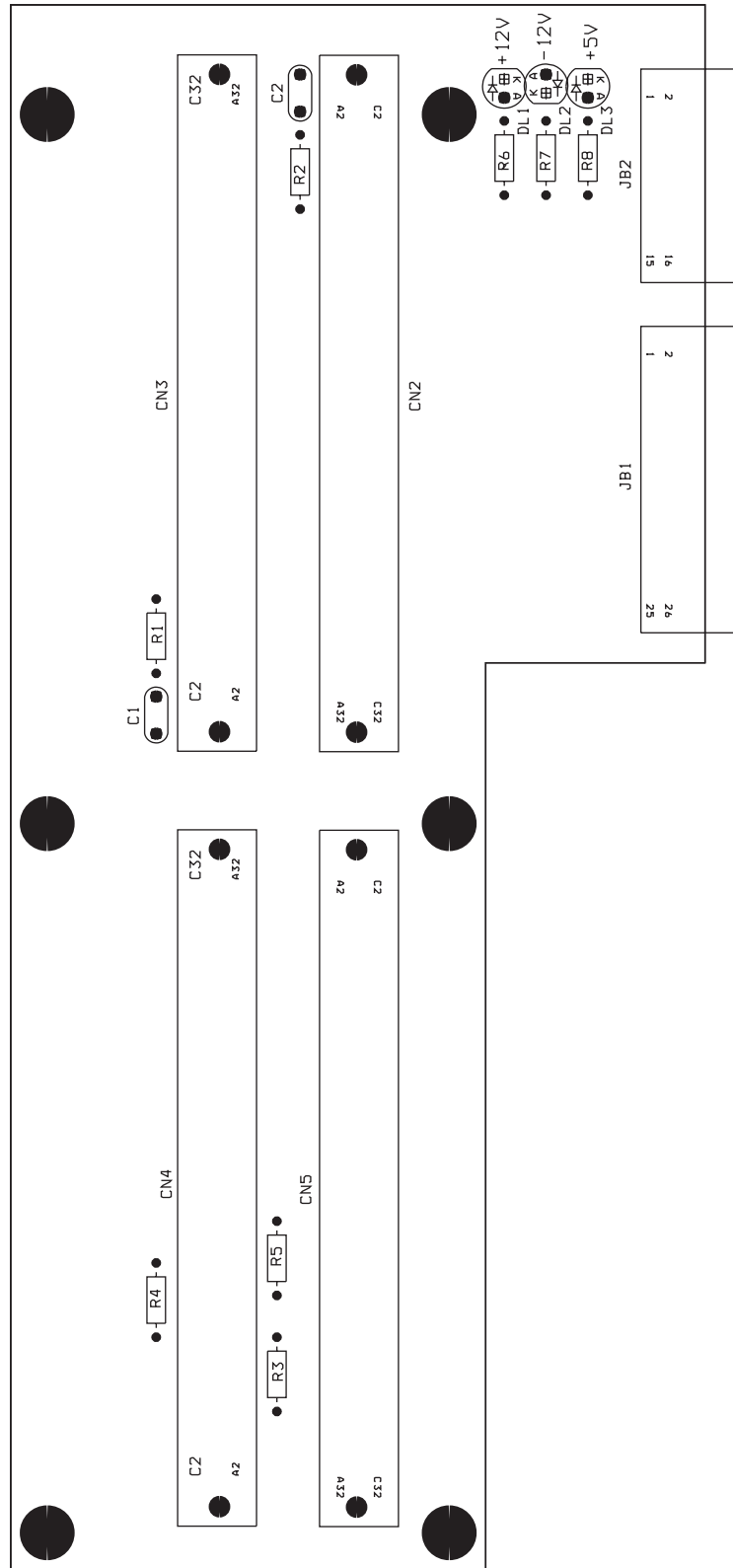

			Via G.Amendola 9 44028 Poggio Renatico (FE) Italy Tel +39 0532 829965 Fax +39 0532 829177 Website WWW.ELENOS.COM
Title: BUS			
Board Code: ETG500BU	Model: ETG101-151	Rev 1.1	
Proj. Engr. : A.Tomassini	Approved : A.Giovannelli		
Date: Wednesday, November 15, 2000	Sheet	1	of 1

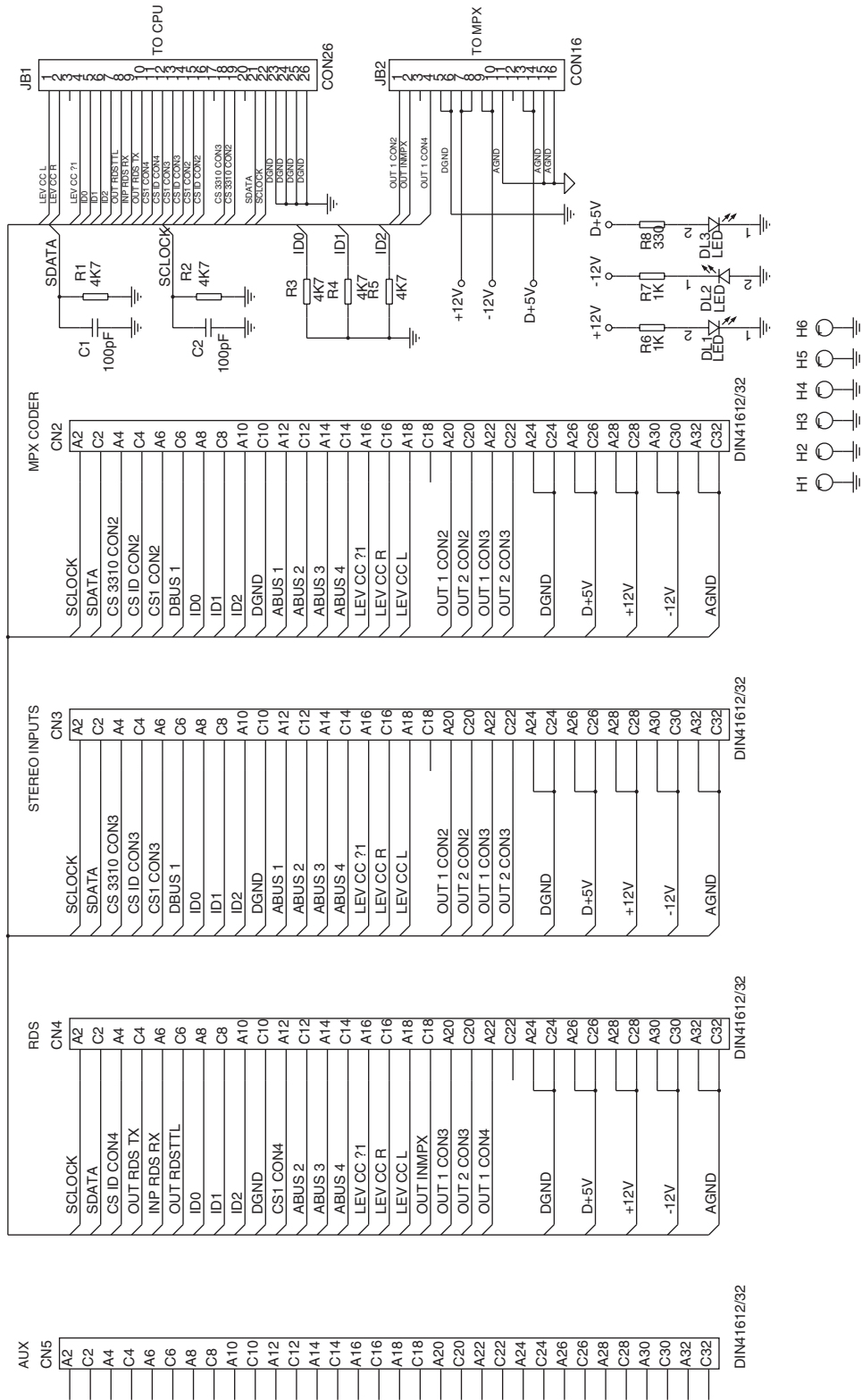

Via G.Amendola 9 44028 Poggio Renatico (FE) Italy Tel +39 0532 829965 Fax +39 0532 829177 Website WWW.ELENOS.COM		Rev
		1.1
Title: BUS		
Board Code: ETG500BU	Model: ETG101-151	
Proj. Engr. : A.Tomassini	Approved : A.Giovannelli	
Date: Wednesday, November 15, 2000	Sheet 1 of 1	

Parts list

Ref.	Description
CN2	DIN41612/32
CN3	DIN41612/32
CN4	DIN41612/32
CN5	DIN41612/32
C2	100pF
C1	100pF
DL1	LED
DL2	LED
DL3	LED
H1	CON1
H2	CON1
H3	CON1
H4	CON1
H5	CON1
H6	CON1
JB1	CON26
JB2	CON16
R1	4K7
R2	4K7
R3	4K7
R4	4K7
R5	4K7
R6	1K
R7	1K
R8	330

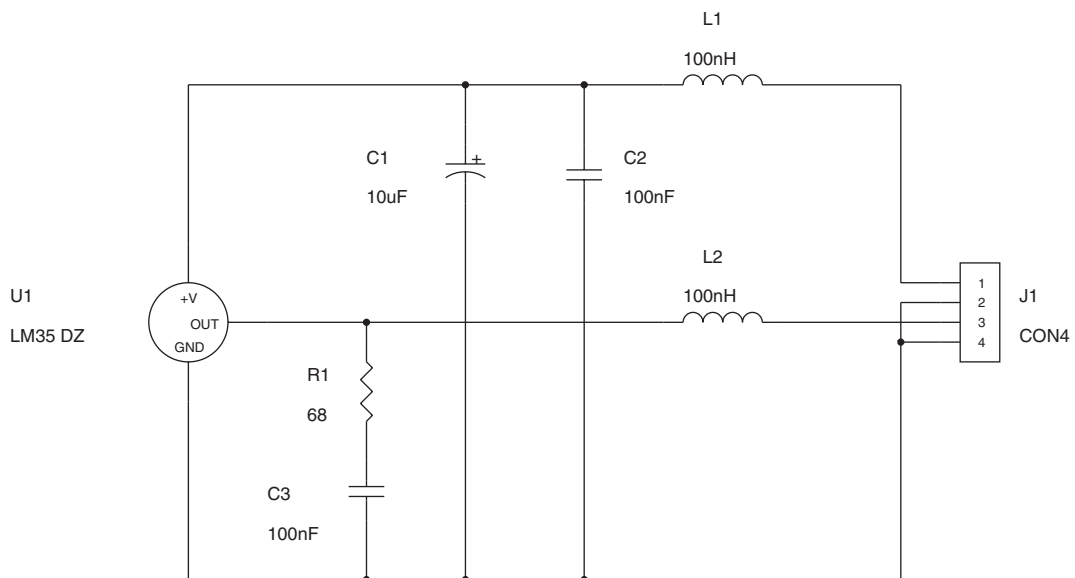
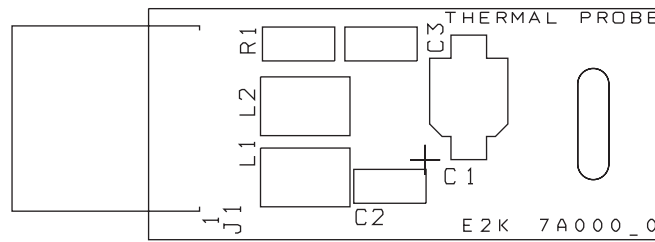

 Via G.Amendola 9 44028 Poggio Renatico (FE) Italy Tel +39 0532 829965 Fax +39 0532 829177 Website WWW.ELENOS.COM		
		Title: THERMAL PROBE
Board Code: E2K 7A000_0	Model: ETG101-151	Rev 0
Proj. Engr. : A.Tomassini	Approved : A.Giovanelli	
Date: Wednesday, November 15, 2000	Sheet 1 of 1	

TROUBLESHOOTING GUIDE

Problem	Cause	Solution
<ul style="list-style-type: none"> ✓ The unit will not power up 	<ul style="list-style-type: none"> ✓ Power cable missing or faulty ✓ Power supply fuses (rear panel) blown ✓ Auxiliary power supply faulty ("MAIN" front panel led not lit) 	<ul style="list-style-type: none"> ✓ Connect or replace power cable and try again ✓ Replace the fuses and try again ✓ Contact the manufacturer
<ul style="list-style-type: none"> ✓ The unit does not reach required power level 	<ul style="list-style-type: none"> ✓ Unit in Stand-By ✓ Antenna or amplifier not connected ✓ PLL unlocked ("ON Air" front panel indicator not lit) ✓ Power supply or RF module faulty 	<ul style="list-style-type: none"> ✓ Access the RF menu and enable "RF On" ✓ Connect the antenna or amplifier (check the integrity of the connection) ✓ Contact the manufacturer ✓ Contact the manufacturer
<ul style="list-style-type: none"> ✓ The unit transmits on the wrong frequency 	<ul style="list-style-type: none"> ✓ PLL board faulty 	<ul style="list-style-type: none"> ✓ Contact the manufacturer
<ul style="list-style-type: none"> ✓ Absence of modulation on the output and on the display 	<ul style="list-style-type: none"> ✓ Missing or faulty audio cable ✓ MPX board faulty ✓ Modulation switched off 	<ul style="list-style-type: none"> ✓ Connect or replace the audio cable ✓ Contact the manufacturer ✓ Enable modulation from the audio menu
<ul style="list-style-type: none"> ✓ Absence of modulation on the output but not on the display 	<ul style="list-style-type: none"> ✓ MPX board faulty 	<ul style="list-style-type: none"> ✓ Contact the manufacturer
<ul style="list-style-type: none"> ✓ Modulation does not reach the required value 	<ul style="list-style-type: none"> ✓ Low audio input level ✓ MPX board faulty ✓ ALC threshold programming error 	<ul style="list-style-type: none"> ✓ Increase the audio input level ✓ Contact the manufacturer ✓ Set the correct threshold
<ul style="list-style-type: none"> ✓ Absence of stereo modulation 	<ul style="list-style-type: none"> ✓ Stereo carrier disabled ✓ Missing or damaged audio cable ✓ Stereo board faulty ✓ Missing stereo board and/or stereo encoder 	<ul style="list-style-type: none"> ✓ Enable stereo carrier from the user setup menu ✓ Connect or replace the audio cable ✓ Contact the manufacturer ✓ Insert stereo board and/or stereo encoder
<ul style="list-style-type: none"> ✓ Absence of RDS transmission 	<ul style="list-style-type: none"> ✓ RDS switched off ✓ RDS message programming error ✓ RDS board missing 	<ul style="list-style-type: none"> ✓ Switch on RDS from the user setup menu ✓ Reprogram RDS board ✓ Insert RDS board

Parameter	Values
FREQUENCY BAND	87.5 - 108.0 MHz in steps of 10KHz
OUTPUT POWER	0 - 100 (150) Watt continuously adjustable
OUTPUT POWER STABILITY	between +/- 0.1 dB
FINAL STAGE TECHNOLOGY	MOSFET
OUTPUT IMPEDANCE	50 Ohm
OUTPUT CONNECTOR	Standard type "N" Female
HARMONIC SUPPRESSION	> 70 dB
SPURIOUS SIGNAL SUPPRESSION	> 80 dB
FREQUENCY STABILITY	Better than 1ppm: (0 - +40°C) in the first year
TYPE OF MODULATION	F3 Direct FM Modulation on RF oscillator at fundamental frequency
RESIDUAL AM	Asynchronous: 0.1% Synchronous: 0.2% (typical values)

Low frequency section

Parameter	Values
V.S.W.R. PROTECTION	Progressively reduced to a safety level (50W)
AUTOMATIC GAIN CONTROL	Stabilises the output power to the level programmed
INTERMODULATION DISTORTION	<0.05% measured with composite tones 1KHz and 1.3KHz, 1:1 ratio at 100% modulation
FREQUENCY DEVIATION	+/- 75KHz adjustable in steps of 0.1dB
THD+N	<0.03% @ 1 KHz
FM S/N RATIO with weighted CCIR filter	-72dB ref. at +/-75KHz dev.
PRE-EMPHASIS	50/75 us +/-0.1dB
FREQUENCY RESPONSE	Mono: +/-0.15dB (30Hz - 15KHz) MPX: +/-0.1dB (30Hz - 100KHz) -45dB at 19KHz Stereo: +/-0.15dB (30Hz - 15KHz) SCA1,2,3: +/-1 dB (20KHz - 100KHz) -45dB at 19KHz
STEREO SEPARATION	65dB @ 1KHz typical value
PILOT TONE	Frequency: 19KHz +/- 1Hz deviation 7.5KHz adjustable
INPUT MODULE AUDIO L/R	Input Impedance: 10KOhm - 600Ohm (selectable) balanced i/p Frequency response: 20Hz - 15KHz Adjustment: -12 - +12dB in steps of 0.1 dB Connector: XLR female
ATTENUATION AT 19KHz	45dB
MPX INPUT MODULE	Impedance 10KOhm unbalanced i/p Frequency response: 30Hz - 100KHz Adjustment: -12 - +12dB in steps of 0.1 dB Connector: BNC female
SCA INPUT	Impedance 10KOhm unbalanced i/p Frequency response: 20KHz - 100KHz Connector: BNC female

General characteristics

Parameter

Value

AMBIENT CONDITIONS

Temperature:
(operating): 0- +45°C
(non operating): -20 - +50°C

Humidity
(operating): 95% at 40°C
(non operating): 90% at 65°C

Altitude:
(operating): >4600 metres
(non operating): > 15000 metres

Parameter

Value

WEIGHT

20Kg

DIMENSIONS

50x14x50 cm

POWER SUPPLY

110-240V

POWER CONSUMPTION

300W typical at maximum power output

COOLING

Forced ventilation

Limitations on cable lengths

RS232

connection cable less than 1m.

MPX

connection cable less than 1m.

SCA1

connection cable less than 1m.

SCA2

connection cable less than 1m.

Power supply cable

length less than 3 m.



BROADCAST EQUIPMENT COMPANY

Via G. Amendola 9 - 44028 Poggio Renatico (FE) - Italy

Tel. +39 0532 829 965 - Fax +39 0532 829 177

E-Mail: info@elenos.com

Internet address: www.elenos.com



UNI EN ISO 9001
Certificato n° 50 100 0165

SINCERT